

# X-ray absorption spectroscopy

## Literature recommendations

- J.C. Vickerman (editor), "Surface Analysis – The Principal Techniques", Wiley, 1997
- J. W. Niemantsverdriet, "Spectroscopy in Catalysis – An Introduction", VCH, 1993
- B. K. Teo, "EXAFS Spectroscopy: Principles and Applications", Plenum Pub Corp, 1981

Jagdeep Singh

Jeroen A. van Bokhoven

# What is XAS?

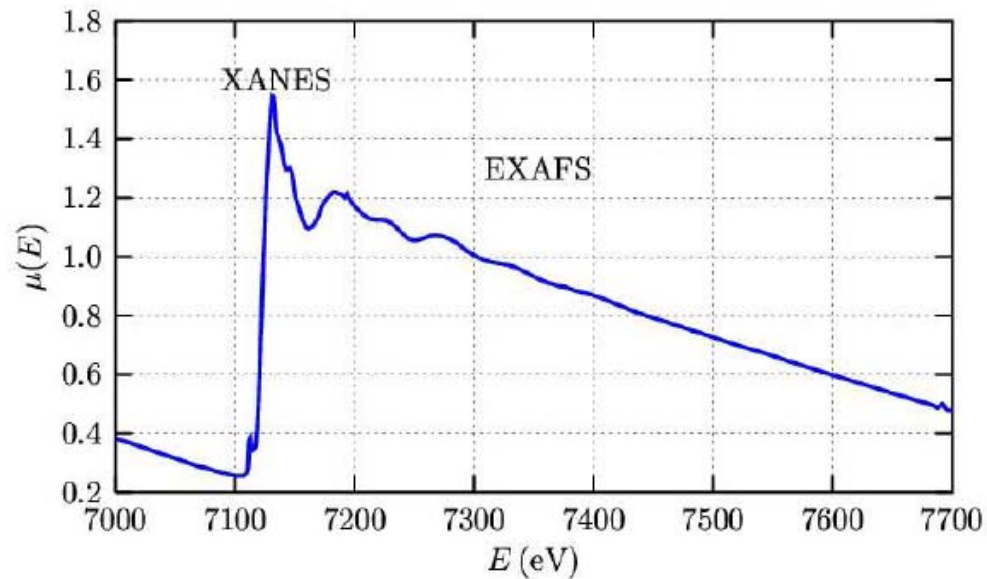
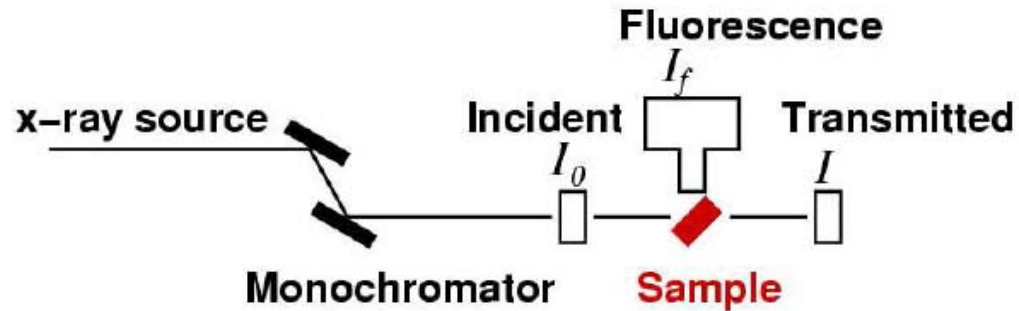

*Absorption as function of energy of the x-ray*

# Data-analysis

Pre-edge subtraction

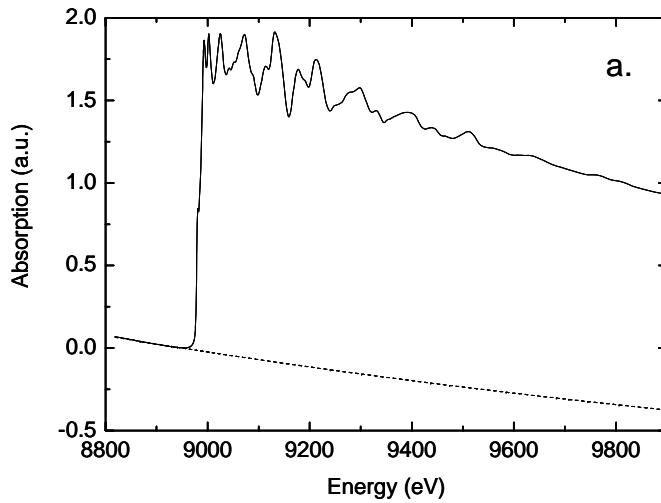

Edge energy determination

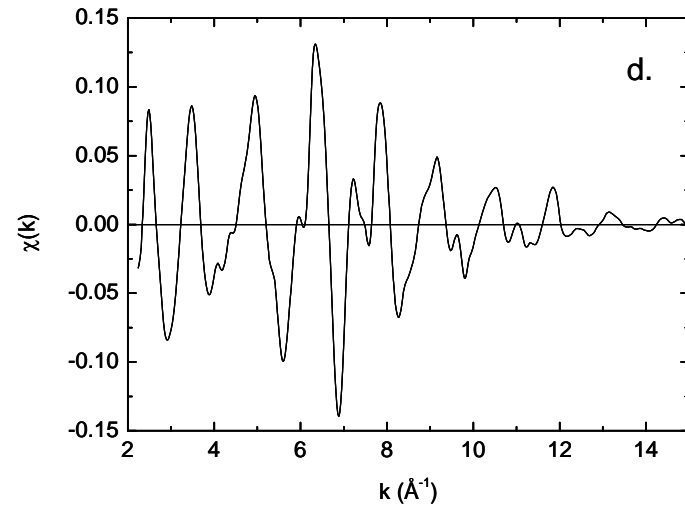
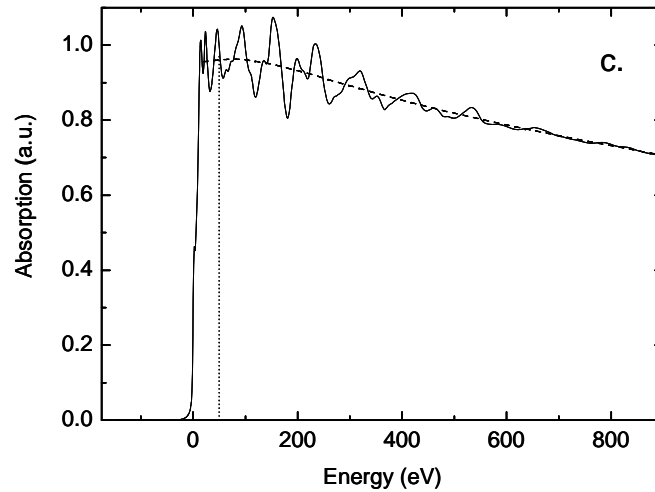
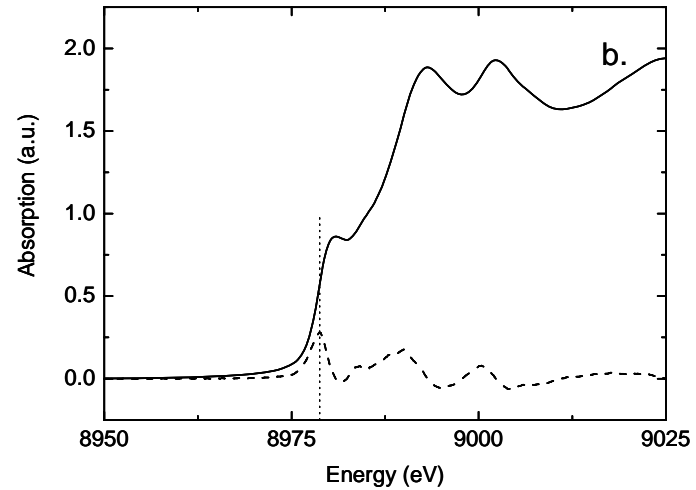

Background and Normalization

EXAFS Function

# EXAFS formula

$$\chi(k) = \sum_i N_i F_i(k) \frac{S_0^2}{kR_i^2} \exp\left(\frac{-2R_i}{\lambda}\right) \exp(-2\sigma_i^2 k^2) \sin(2kR_i + \varphi_j(k))$$

Scatter power                      Damping                      Disorder

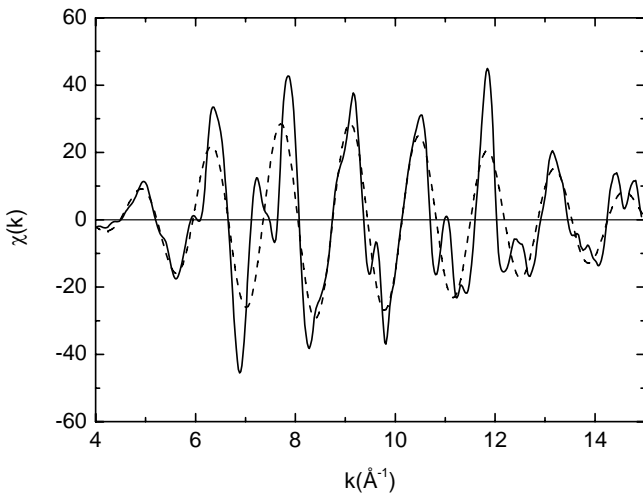

Fourier transformation  
→

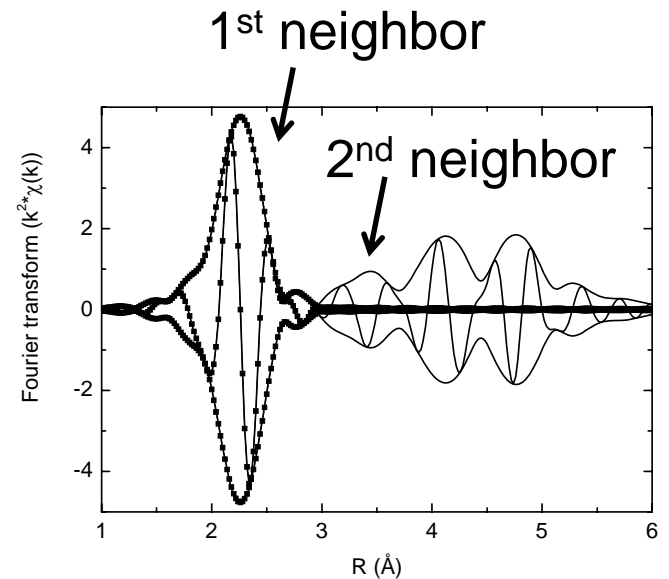

*radial distribution function*

$$\chi(k) = \sum_i N_i F_i(k) \left[ \frac{S_0^2}{kR_i^2} \exp\left(\frac{-2R_i}{\lambda}\right) \exp(-2\sigma_i^2 k^2) \sin(2kR_i + \varphi_j(k)) \right]$$

Scatter power
Damping
Disorder

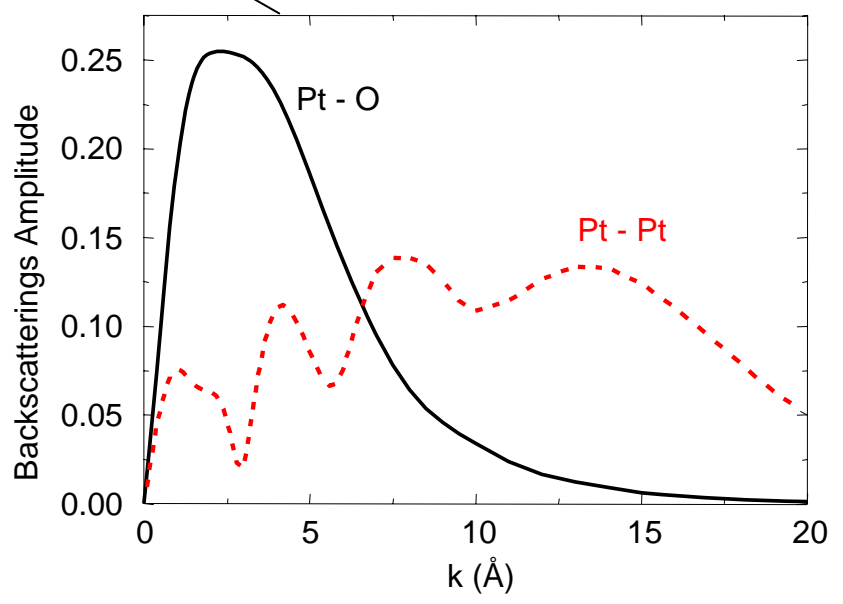
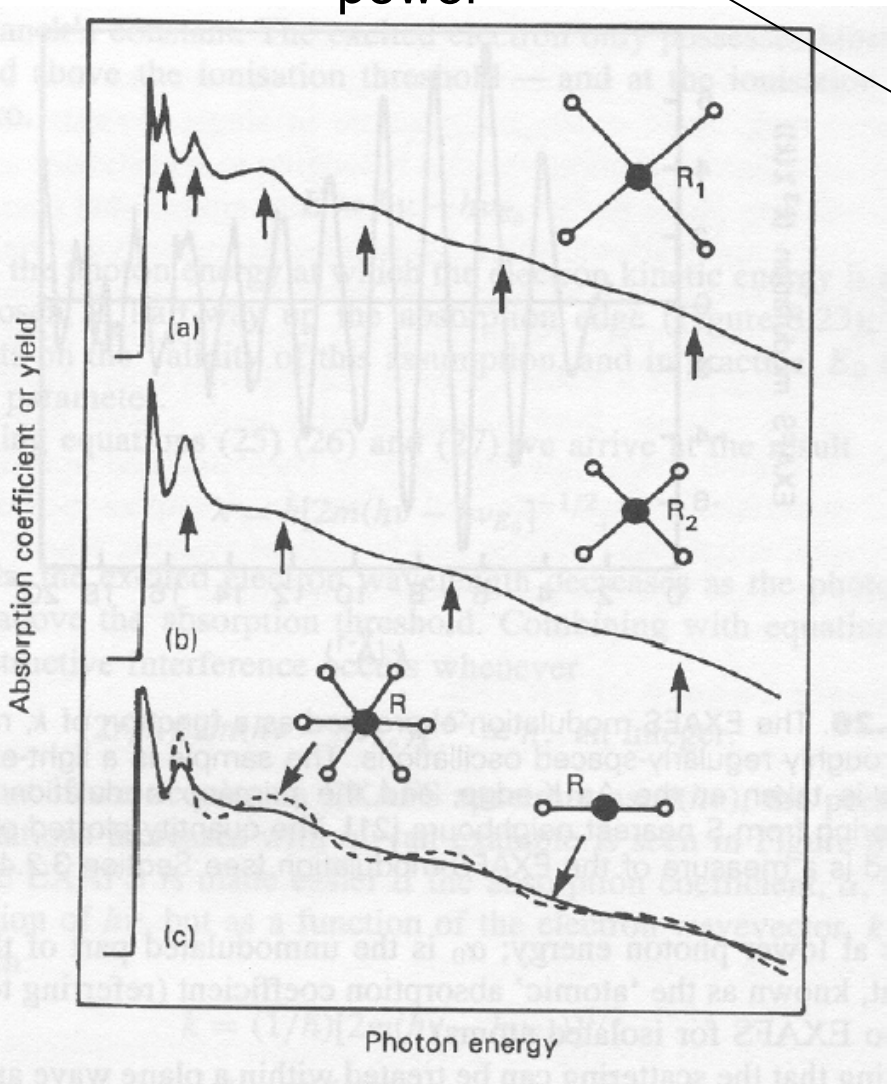

# Temperature effect on EXAFS / XANES

$$\chi(k) = \sum_i N_i F_i(k) \frac{S_0^2}{kR_i^2} \exp\left(\frac{-2R_i}{\lambda}\right) \exp(-2\sigma_i^2 k^2) \sin(2kR_i + \varphi_j(k))$$

Scatter power      Damping      Disorder

*Temperature effect*

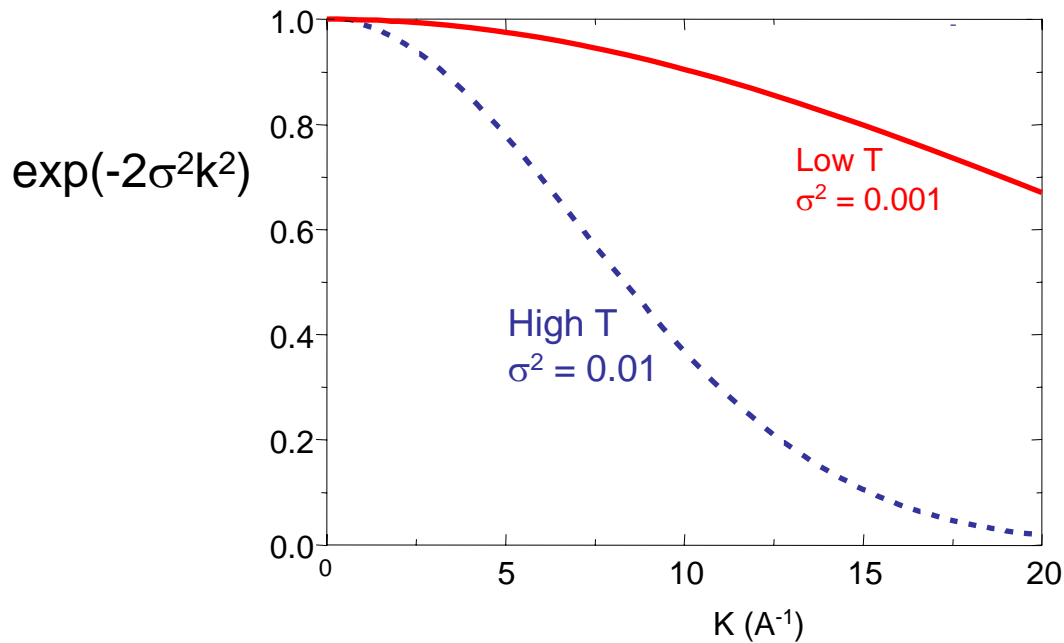

# Getting structural information from EXAFS

$$\chi(k) = \sum_i N_i F_i(k) \frac{S_0^2}{k R_i^2} \exp\left(\frac{-2R_i}{\lambda}\right) \exp(-2\sigma_i^2 k^2) \sin(2kR_i + \varphi_j(k))$$

$F_j$ ,  $\varphi_j$ , and  $S_0^2$  from reference compound or theory

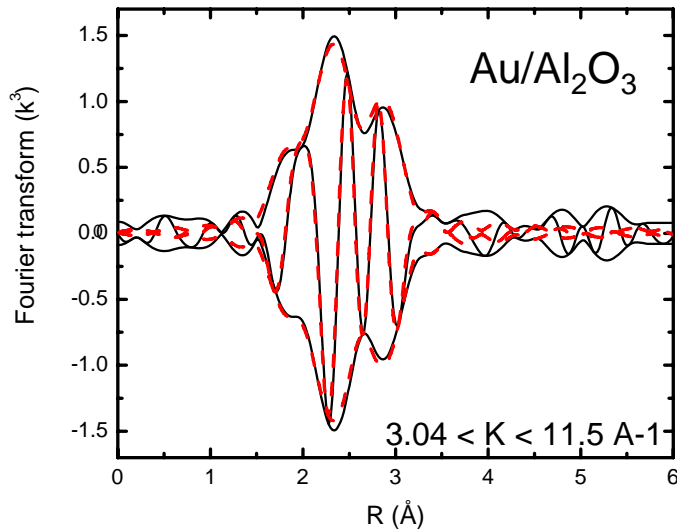

Coordination number	<b>6.8</b>
Au-Au distance	<b>2.76 Å</b>
$\Delta$ DWF	<b>0.0058</b>
C3	9 E-6
C4	3E-6

Added parameter:  $\Delta E_0$

# Abstract

- EXAFS gives local structure
- XANES gives geometry and oxidation state (empty density of states)



# Information contained in an XAS Spectrum

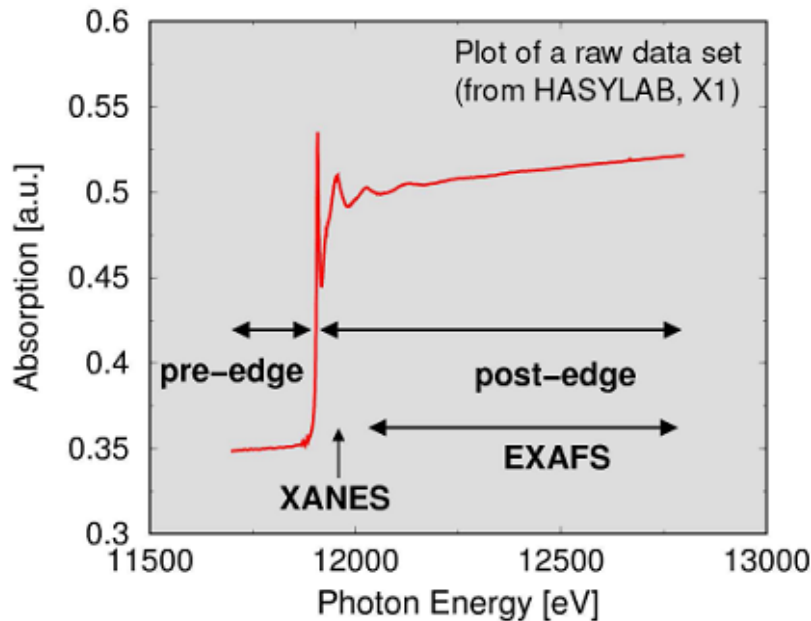

## Fine Structure is given by

- single scattering → EXAFS
- multiple scattering → XANES
- electronic transitions → XANES

## Electronic Information

- Angular momentum projected DOS
- transition probabilities

## Structural Information

- position of atoms
- degree of order
- phase composition
- *in-situ* conditions

# Data Analysis: Fitting Process 1<sup>st</sup> coordination shell

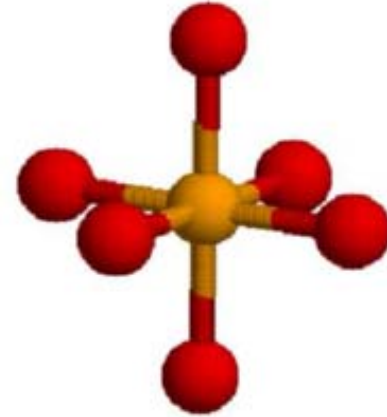
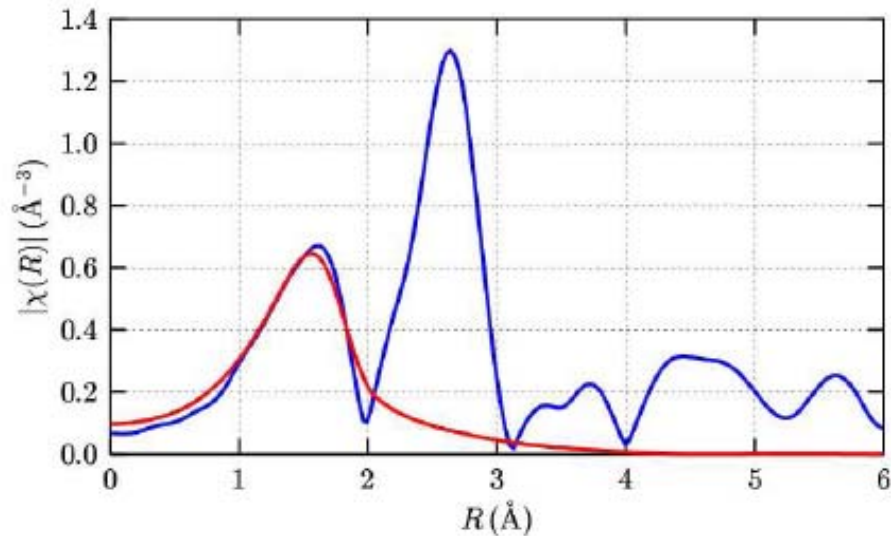

Parameter	Value
N	5.8
R	2.1
$\Delta E_0$	-3.1
$\sigma^2$	0.015

$$\chi(k) = \sum_i N_i F_i(k) \frac{S_0^2}{kR_i^2} \exp\left[\frac{-2R_i}{\lambda}\right] \exp(-2\sigma_i^2 k^2) \sin(2kR_i + \varphi_i(k))$$

Scatter power
Damping
Disorder

## Data Analysis: 1<sup>st</sup> coordination shell in k-space

---

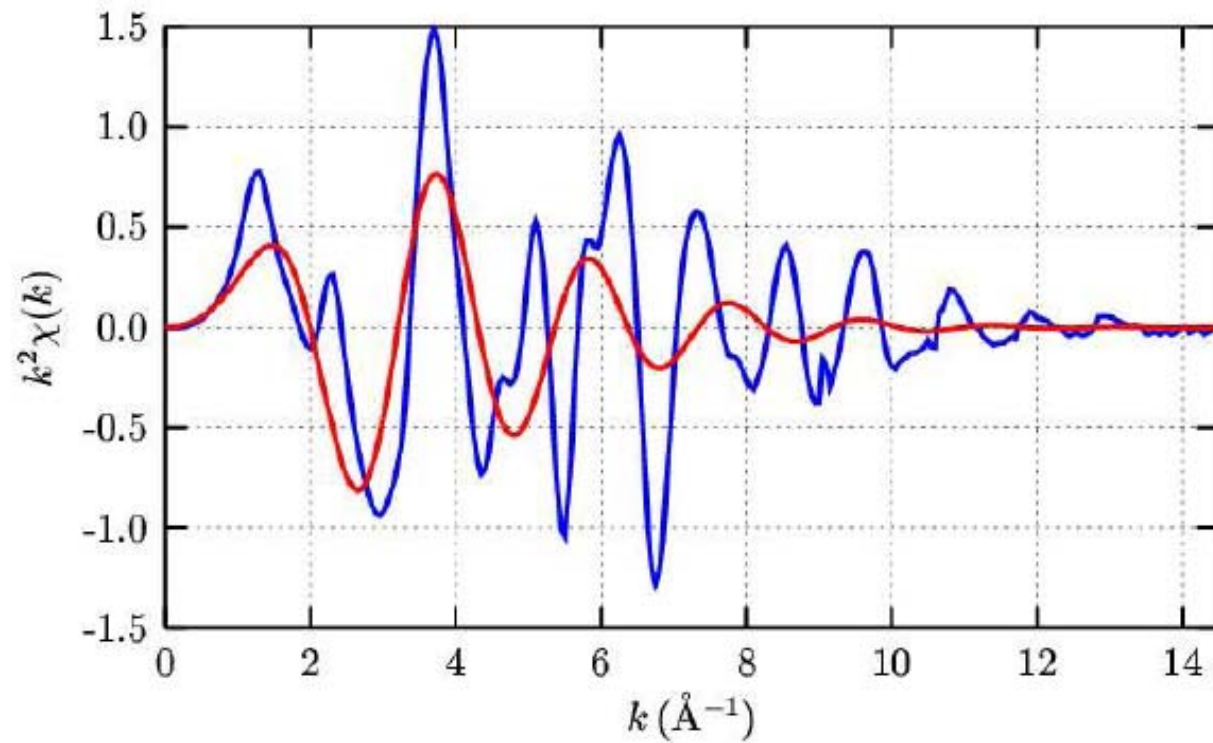

## Data Analysis: Adding the 2<sup>nd</sup> coordination shell

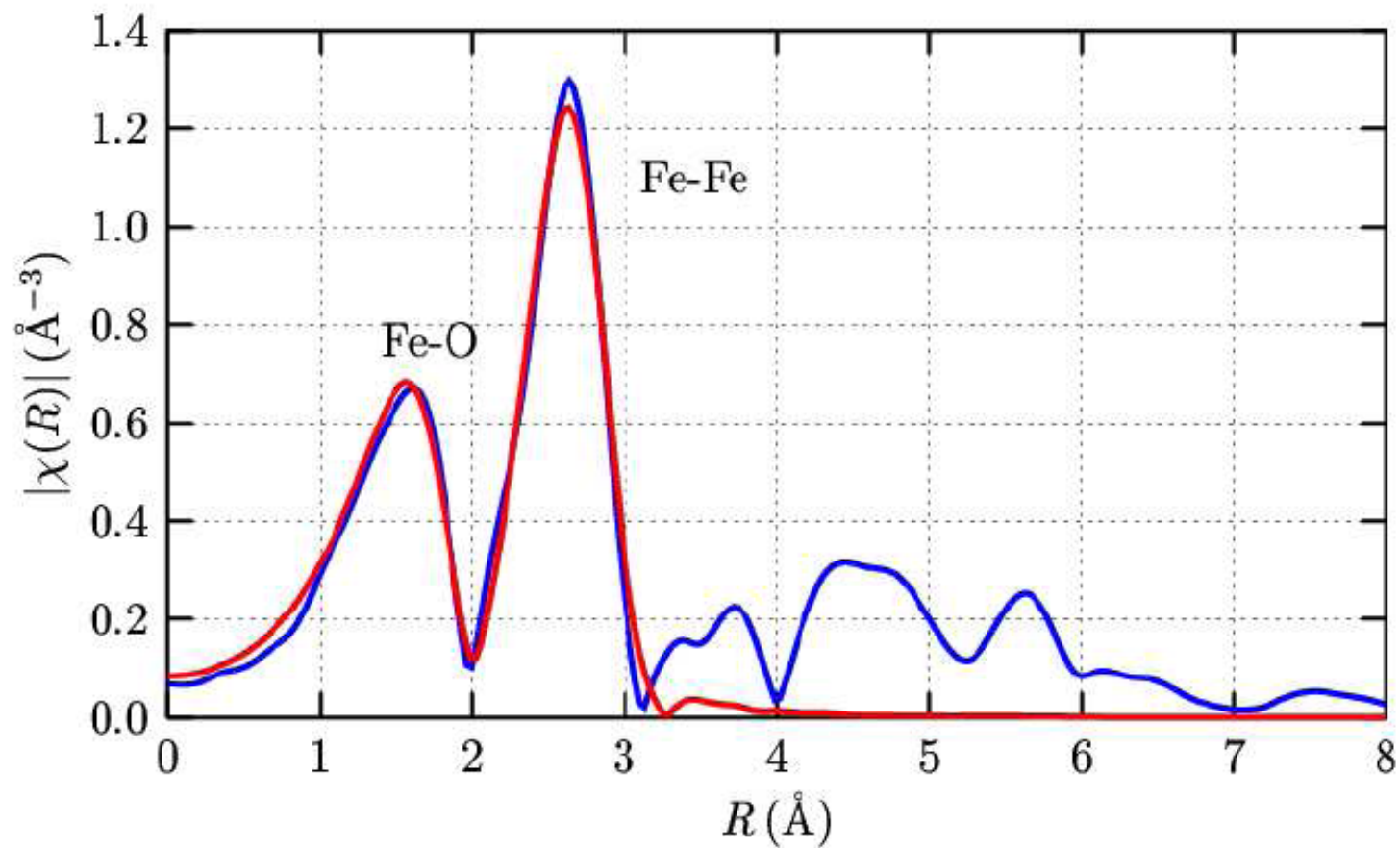

## Data Analysis: Other ways of looking at the fit

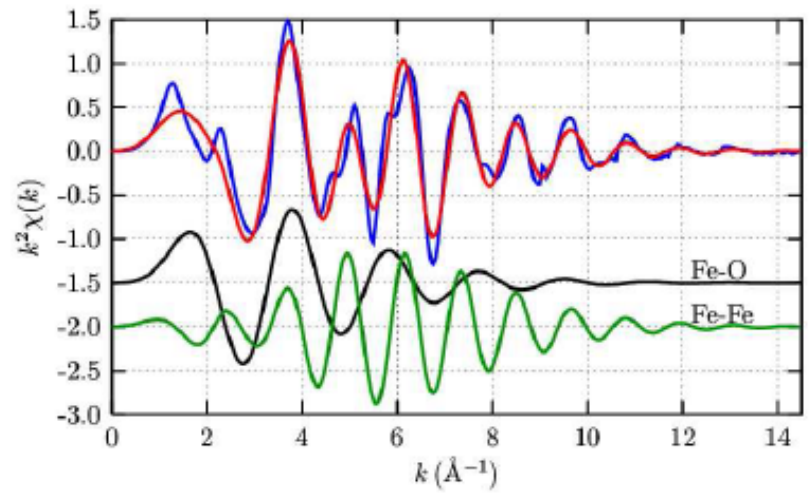
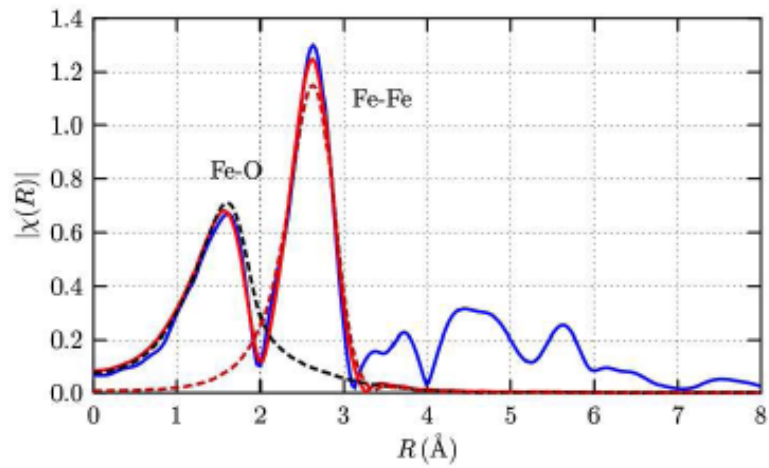

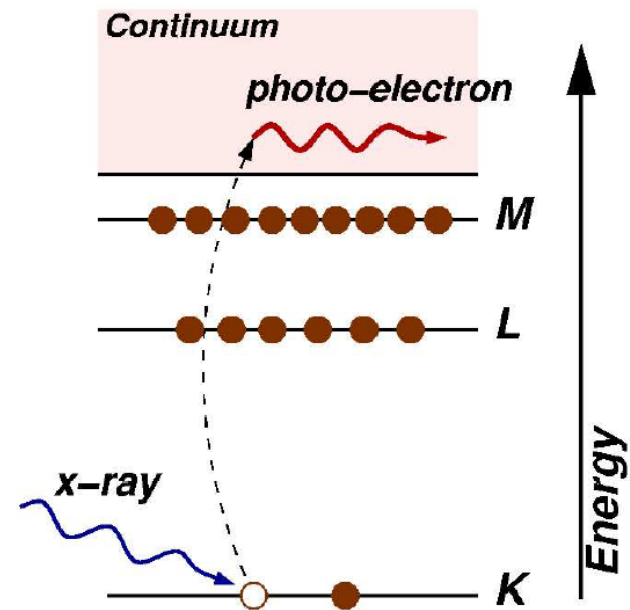
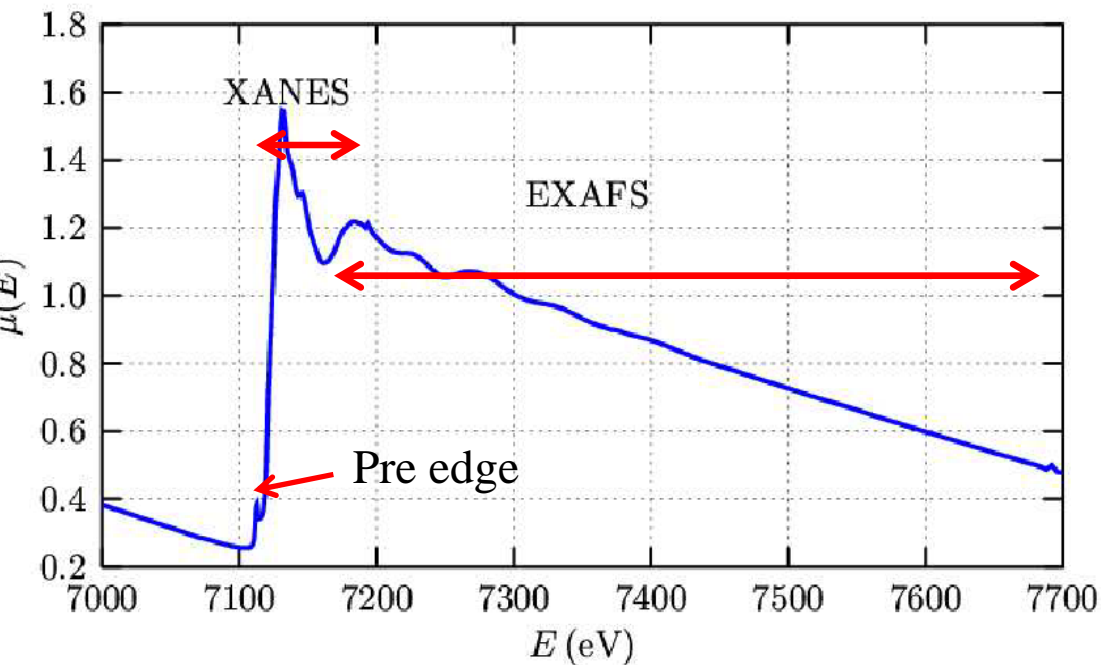

**EXAFS** ( $\chi$ ) Extended **X**-ray **A**bsorption **F**ine-**S**tructure  
*Single scattering*

**XANES** **X**-ray **A**bsorption **N**ear-**E**dge **S**tructure  
*Multiple scattering*

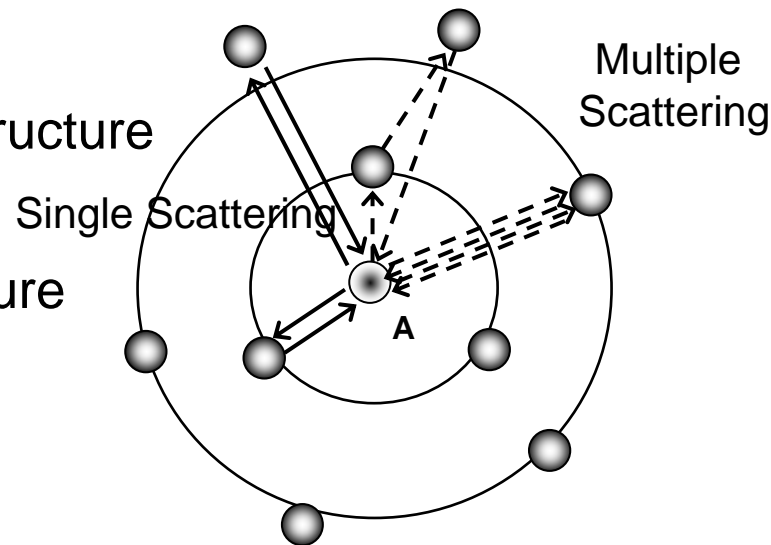

# XANES versus EXAFS

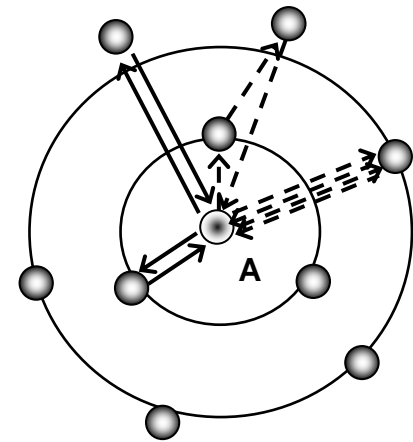

## EXAFS

- Single scattering dominates

## Information

- Number & kind of neighbor
- Distance
- Disorder

## XANES

- Multiple scattering
- Electronic transitions
- Multiple electron transitions

- Geometry / subtle distortions
- Oxidation state
- Electronic information
- DOS in *final state*

## Theoretical description of XANES

- Detailed electronic information
- Aids interpretation of spectra of unknown compounds
- Time-consuming
- Needs an expert

# XAS in Catalysis

## *Goal*

Local structure of catalysts under well-defined conditions

precursor state

during / after activation

during reaction

deactivation

time-resolution (**few msec**)

space-resolution (**few  $\mu\text{m}$** )

... ..



# Palladium hydride formation

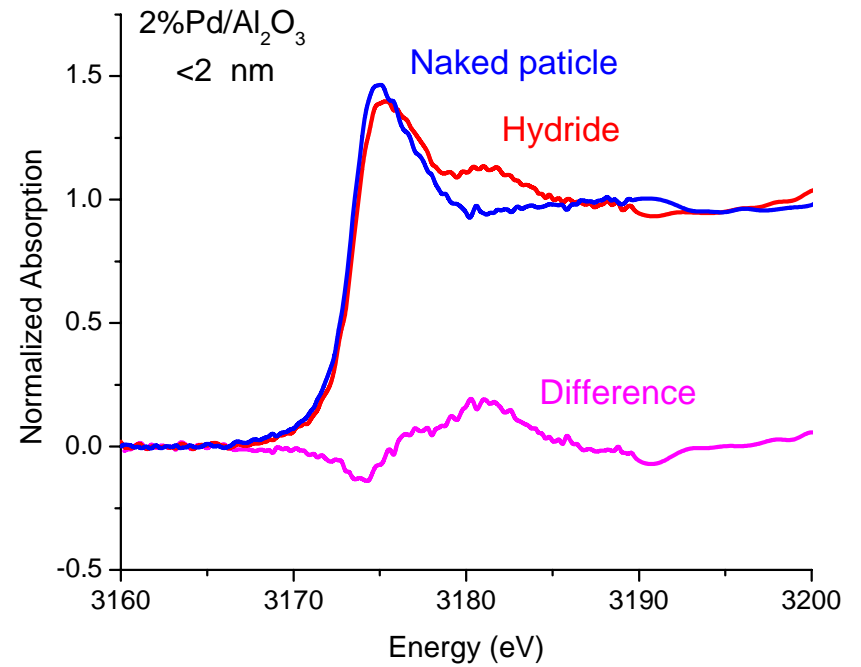
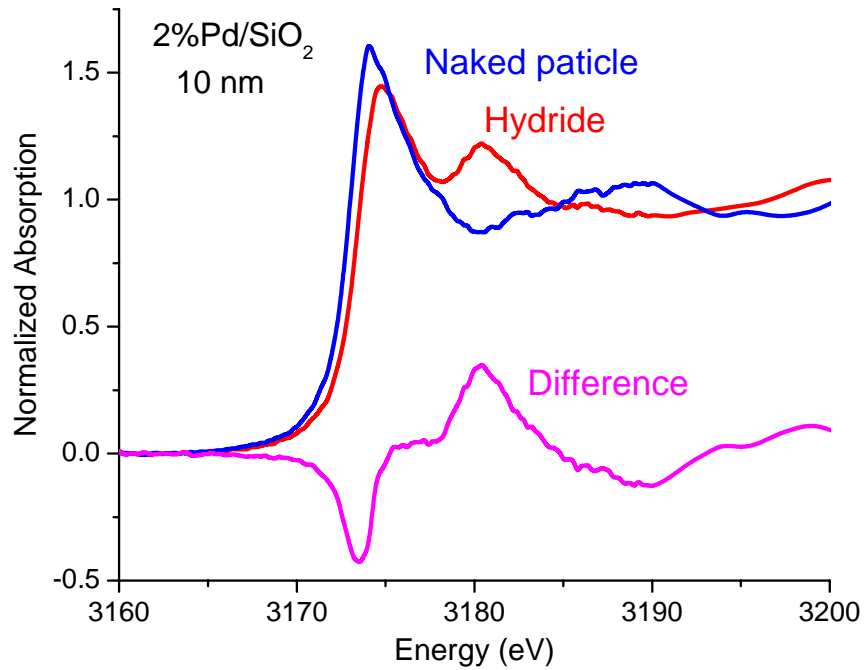

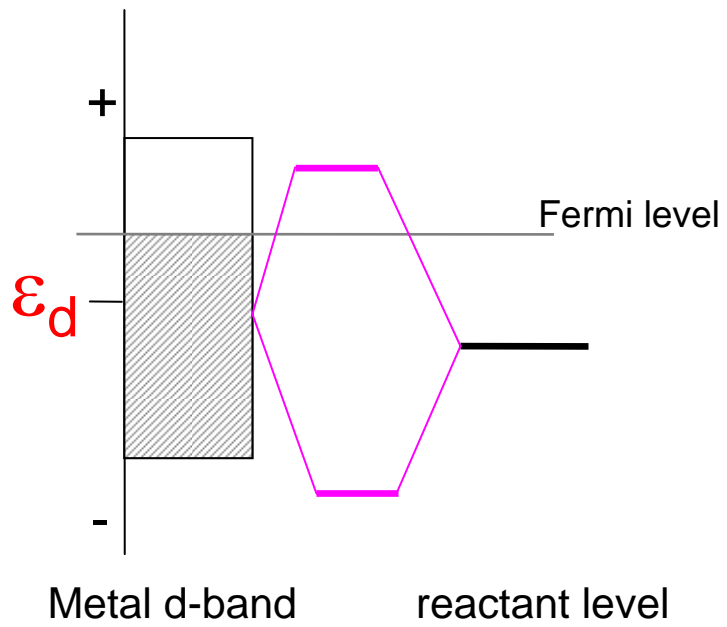

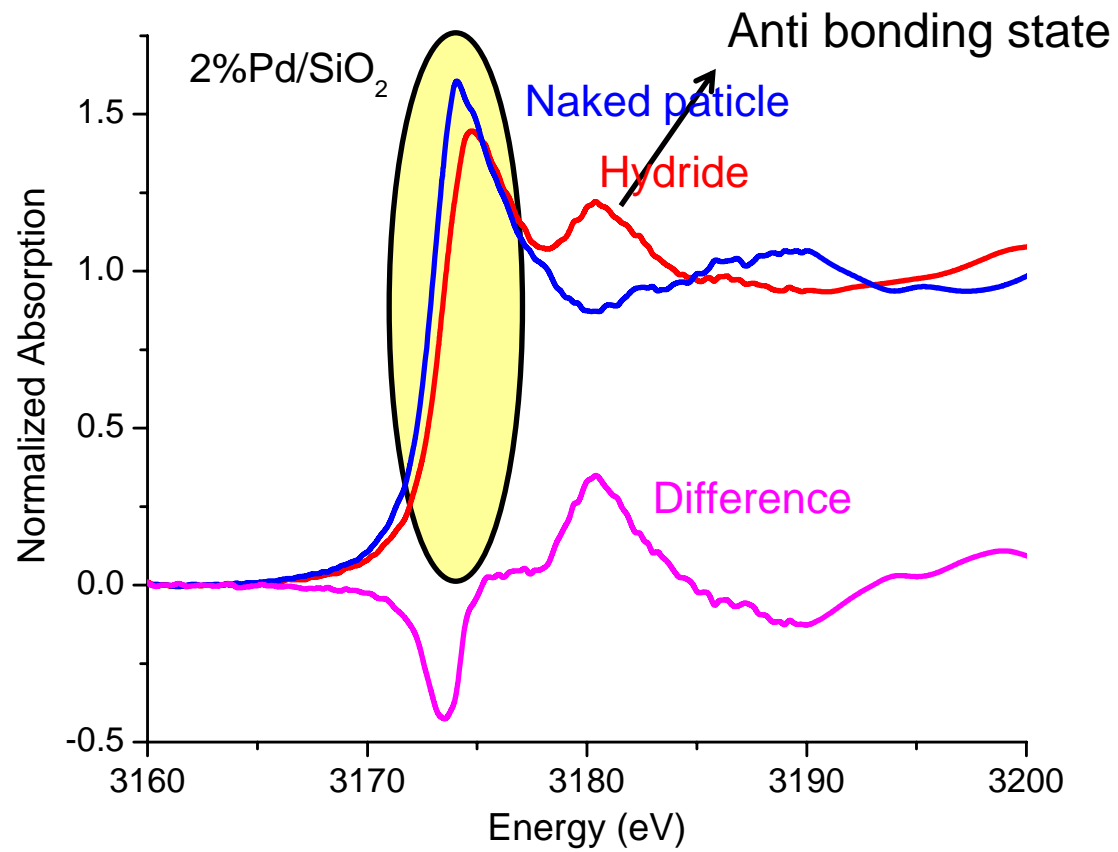

DOS vs XANES for PdH<sub>0.64</sub> (93 atoms)

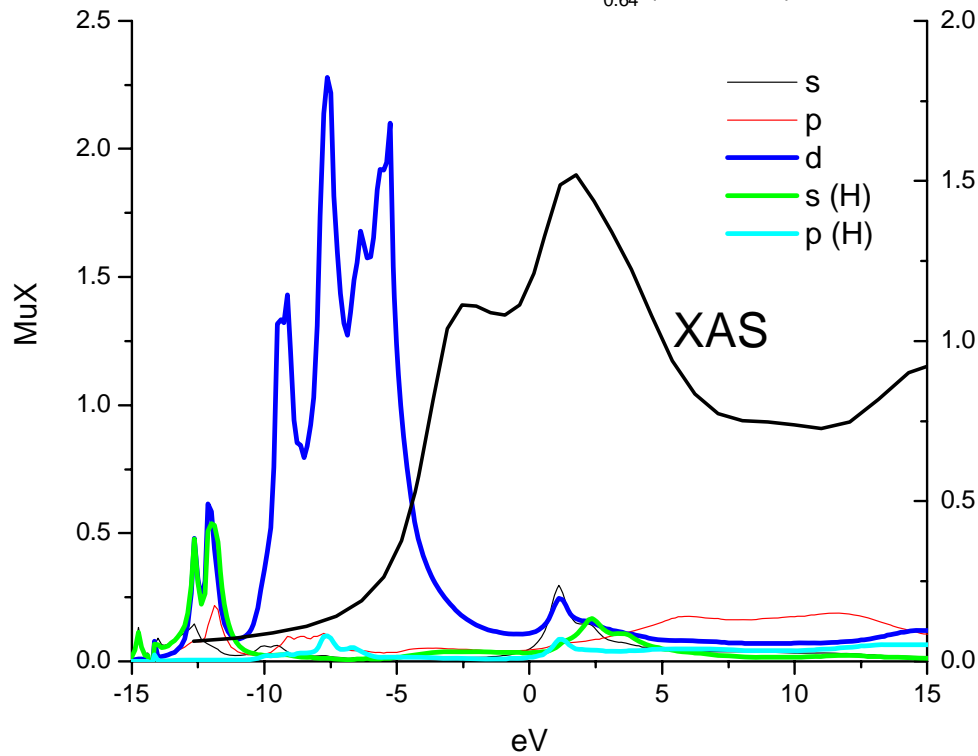

DOS vs XANES for PdH<sub>0.64</sub> (93 atoms)

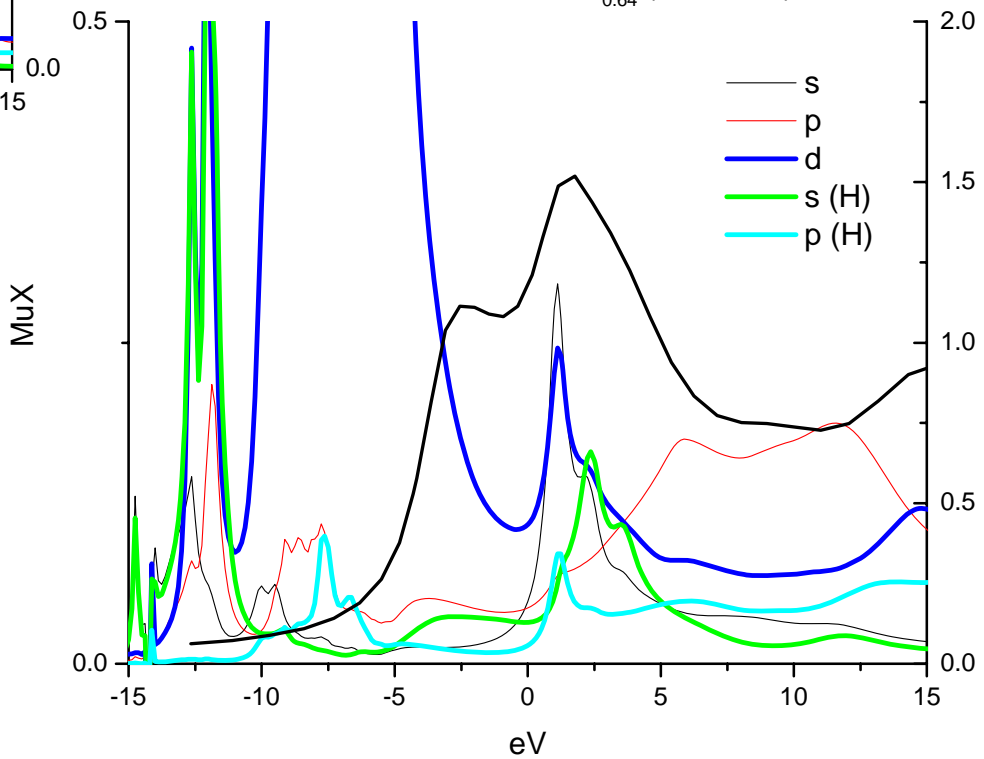

# Catalysis by Gold

Partial / complete oxidation of hydrocarbons

methane, alkenes, methanol

Hydrogenation / dehydrogenation reactions

alkenes, alkynes, alkadienes, (un)saturated ketones

Methanol synthesis

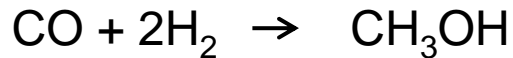

WGS

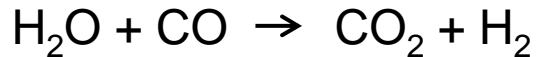

Nitric Oxide reduction (with CO, olefins, or H<sub>2</sub>)

CO oxidation

1925: Active in CO oxidation

*highly active in presence of H<sub>2</sub>: Haruta Catal. Today 36 (1997) 153*

*Selective CO removal, air purification, high-purity N<sub>2</sub> and O<sub>2</sub>*

# Catalysis by Gold

## Physical properties

- bulk metallic gold is thermodynamically stable
- melting point and metallicity of the particle is function of particle size

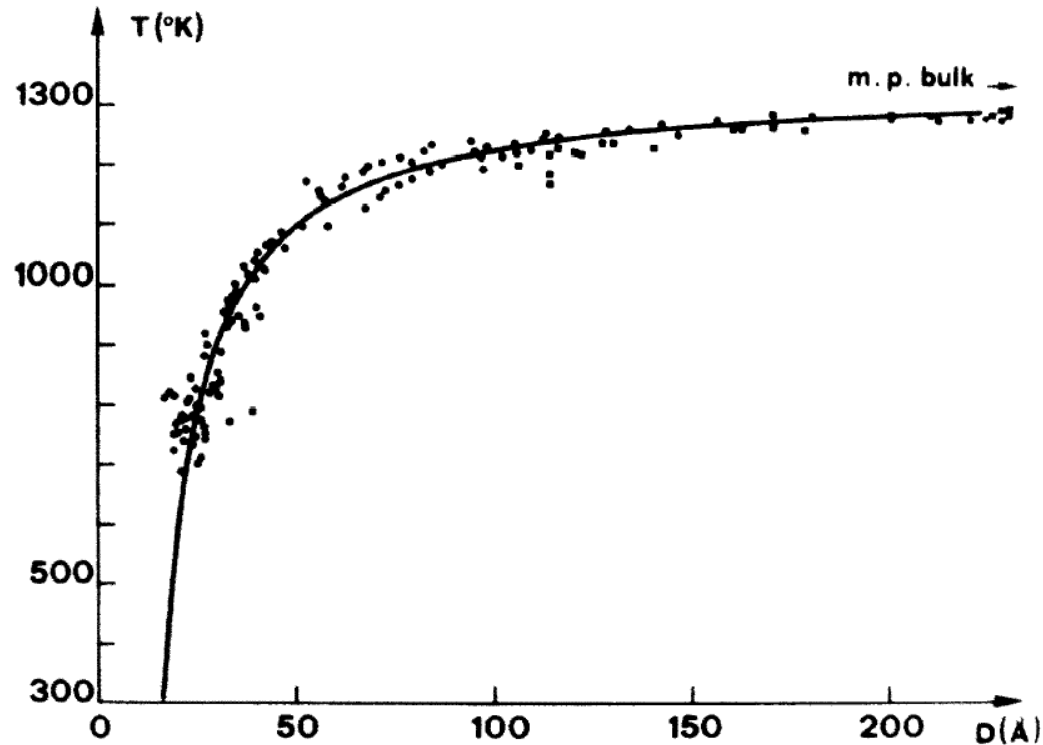

Buffat Phys. Rev. A 13 (1976) 2287

# Catalysis by Gold

## Physical properties

- bulk metallic gold is thermodynamically stable
- melting point and metallicity of the particle is function of particle size

## CO oxidation: particle-size effect

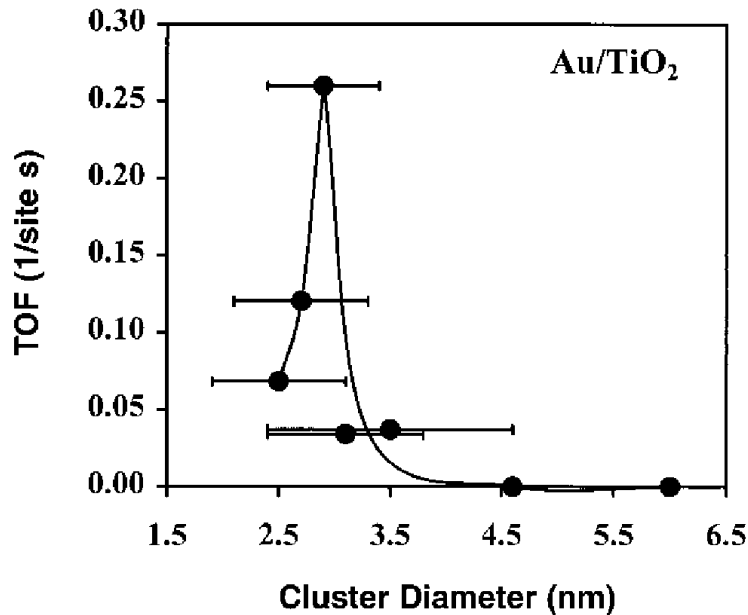

Goodman *Science* 281 (1998) 1648

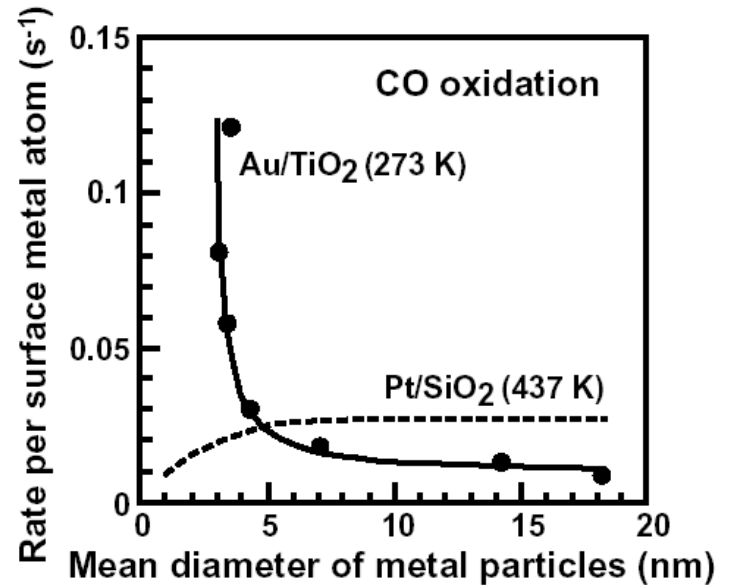

Haruta *Cattech* 3 (2002) 102

# Catalysis by Gold

Physical properties:

- bulk metallic gold is thermodynamically stable
- melting point and metallicity of the particle is function of particle size

CO oxidation: particle-size effect

Large support effects:

SiO<sub>2</sub>: hardly active

Al<sub>2</sub>O<sub>3</sub>, MgO: moderately active

(TiO<sub>2</sub>) Fe<sub>2</sub>O<sub>3</sub>, CeO<sub>2</sub>, *other reducible supports*: very active & less dependent on particle sizes; No clear relation to reducibility of support

Active species in gold oxidation catalysis?

- Carbonate-mechanism excluded
- Small particles become active as soon as they are non-metallic (Goodman)
- Oxidic gold (I or III) is active species (Gates)
- Theory supports both gold-only and support-aided mechanism
- Support supplies oxygen *via molecularly (activated) adsorbed oxygen via Mars van Krevelen*



Geometry / coordination

Density of states

Oxidation state

Time resolved

In situ

*How is oxygen activated on the catalyst?*

*How can the most inert metal be so active?*

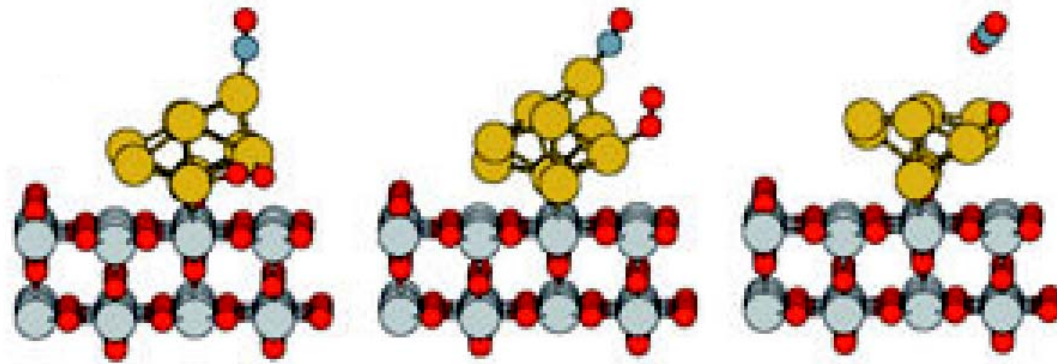

Nørskov *et al.* *Angew. Chem.* **44** (2005) 1824

Small gold particles adsorb oxygen  
(and react)

# Structure of gold catalysts

## Sample Preparation

- Deposition precipitation  $\text{HAuCl}_4$  adjusted pH
- Washing with a base to remove chlorine
- Reduction in hydrogen

## *Supports*

$\text{Al}_2\text{O}_3$ ,  $\text{SiO}_2$ ,  $\text{CeO}_2$ ,  $\text{TiO}_2$ ,  $\text{ZrO}_2$ ,  $\text{Nb}_2\text{O}_5$

Full EXAFS & XANES analyses

# EXAFS Fitting Results of Reduced Catalysts

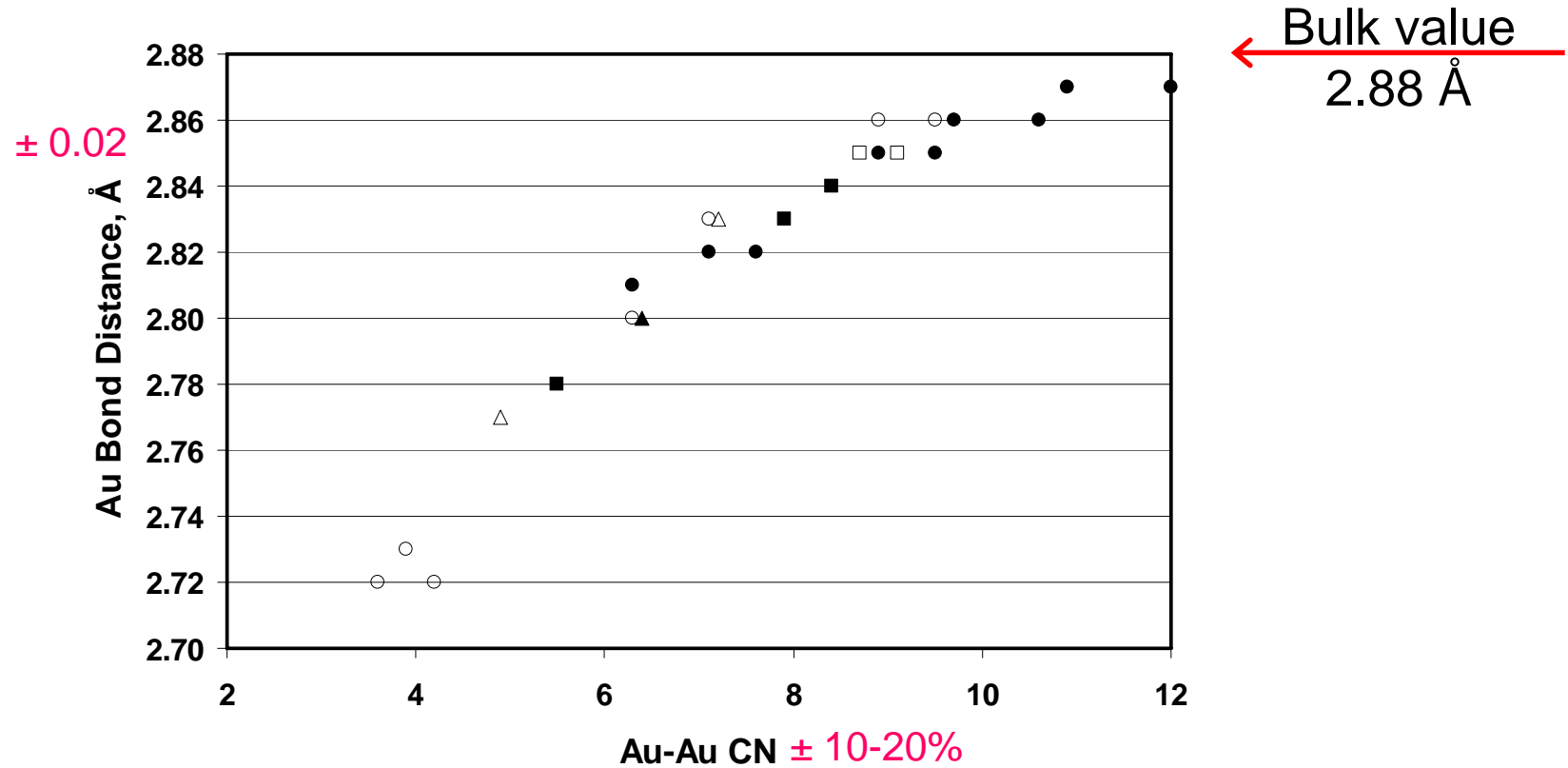

# EXAFS Fitting Results of Reduced Catalysts

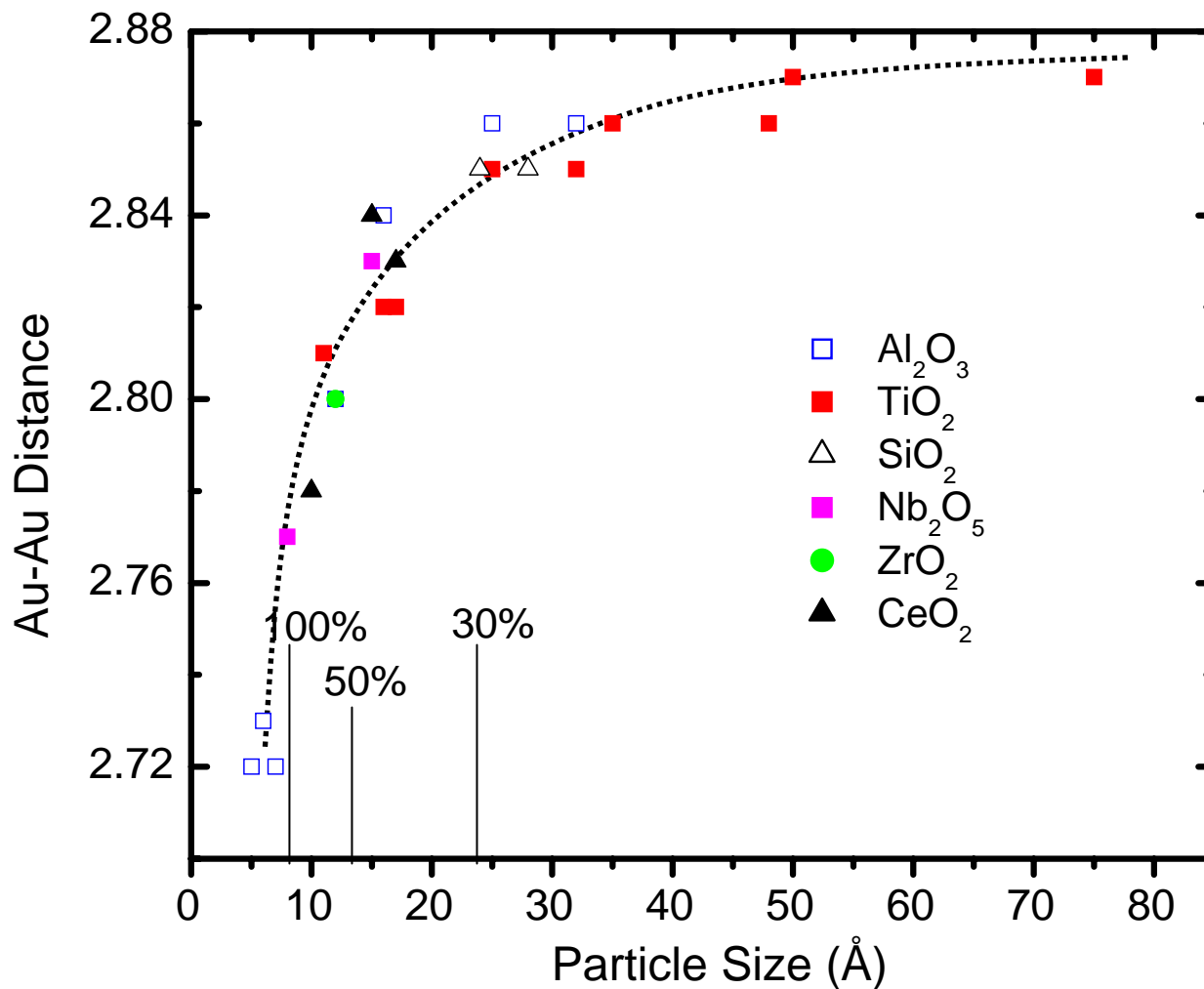

*Strong reduction in Au-Au distance with particle size*  
*No visible influence of support*

# Electronic structure from $L_{III}$ XANES

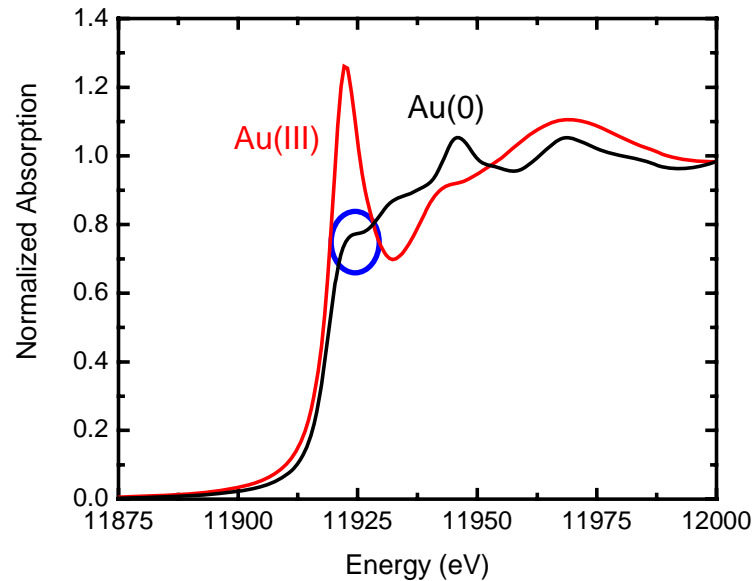

*Whitelines reflect number of holes in the d-band*

*Gold whiteline: spd-rehybridization results in  $5d^{10-x}6sp^{1+x}$*

# Whitelines reflect number of holes in the d-band

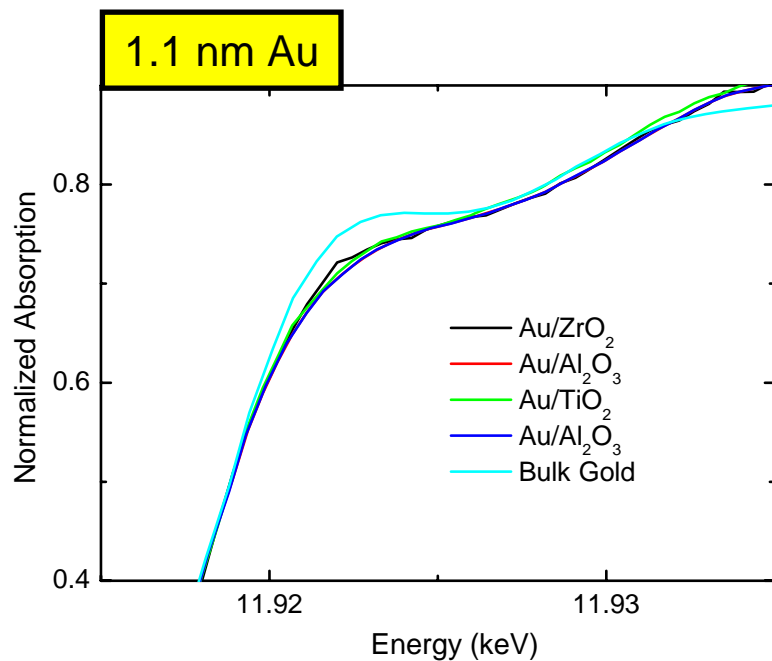
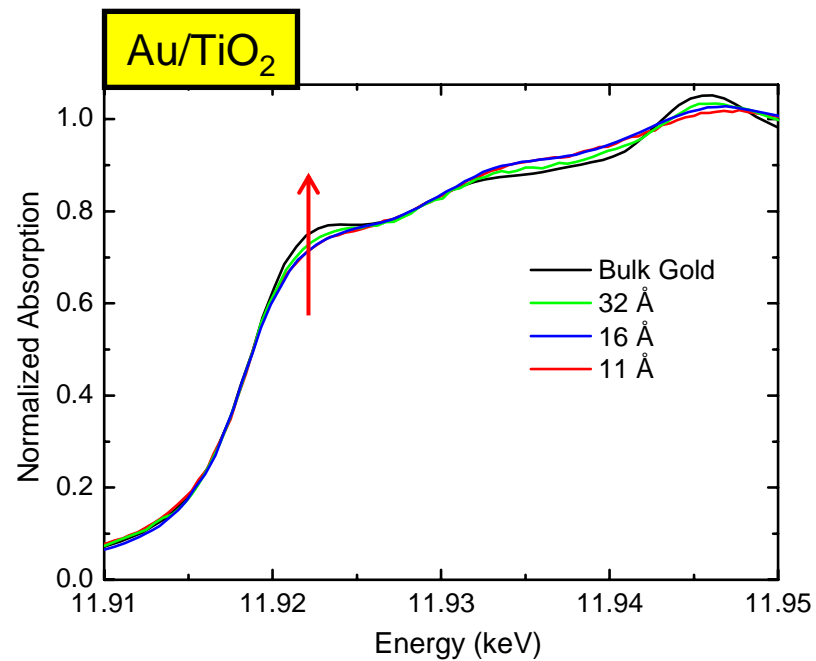
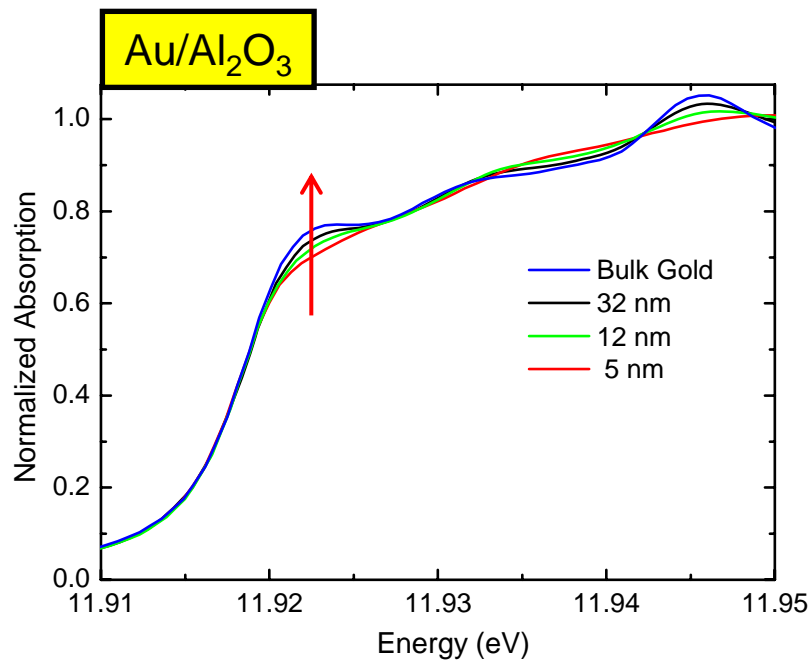

*Whiteline is particle-size dependent*



# Whiteline intensity versus particle size

*Difference intensity with bulk*

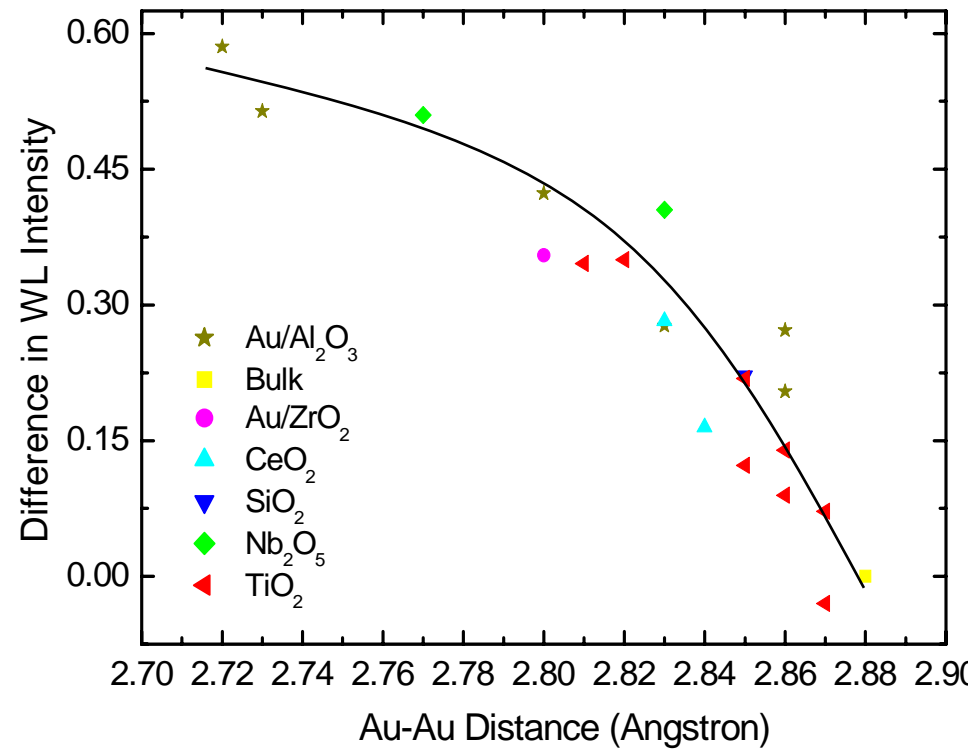
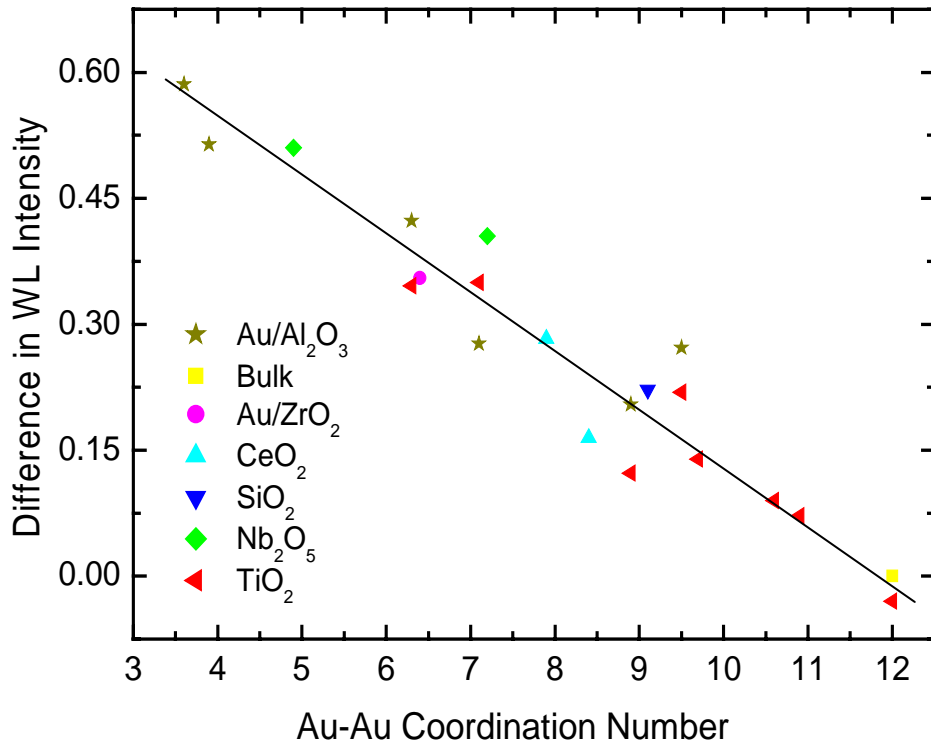

*Six supports, one trend*  
*Larger particles fewer d-electrons*

# Exposure to 20% O<sub>2</sub>

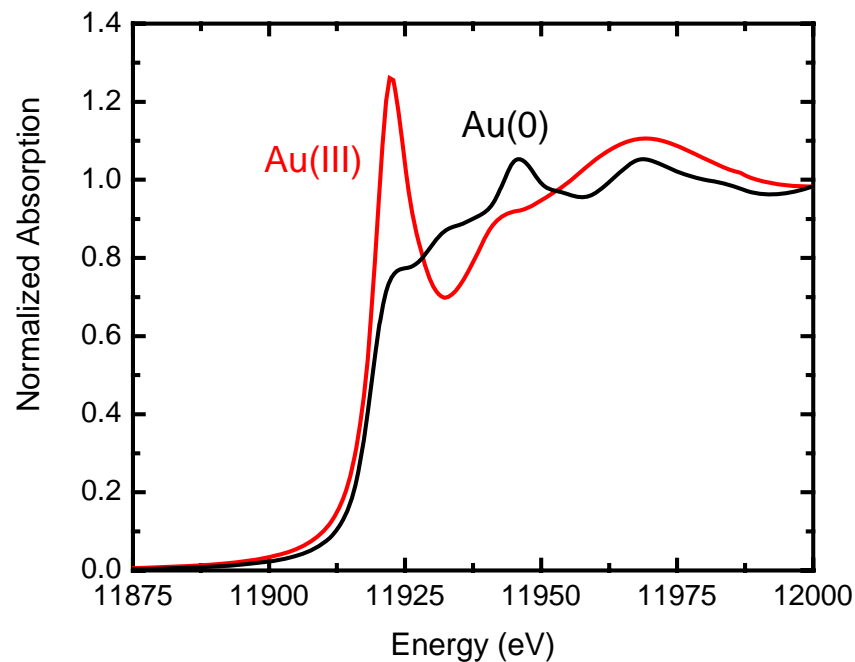
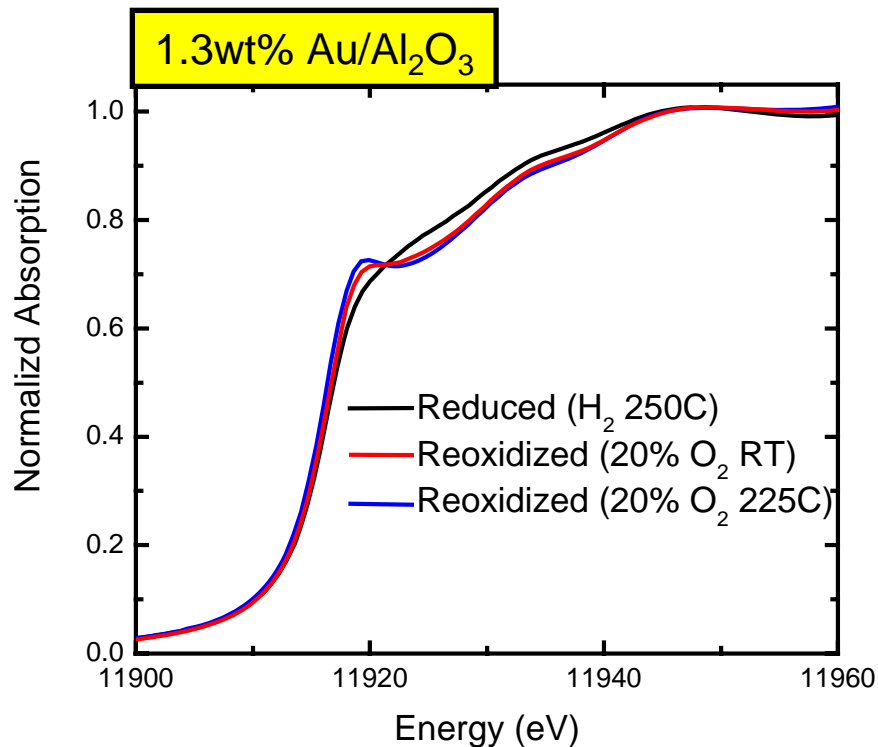

	CN	R(Å)	%Au(III)
Reduced	3.6	2.72	0
Reox. RT	3.6 / 0.3	2.72 / 2.04	10
Reox. 225C	2.7 / 0.5	2.71 / 2.04	15

# XAS during CO Oxidation

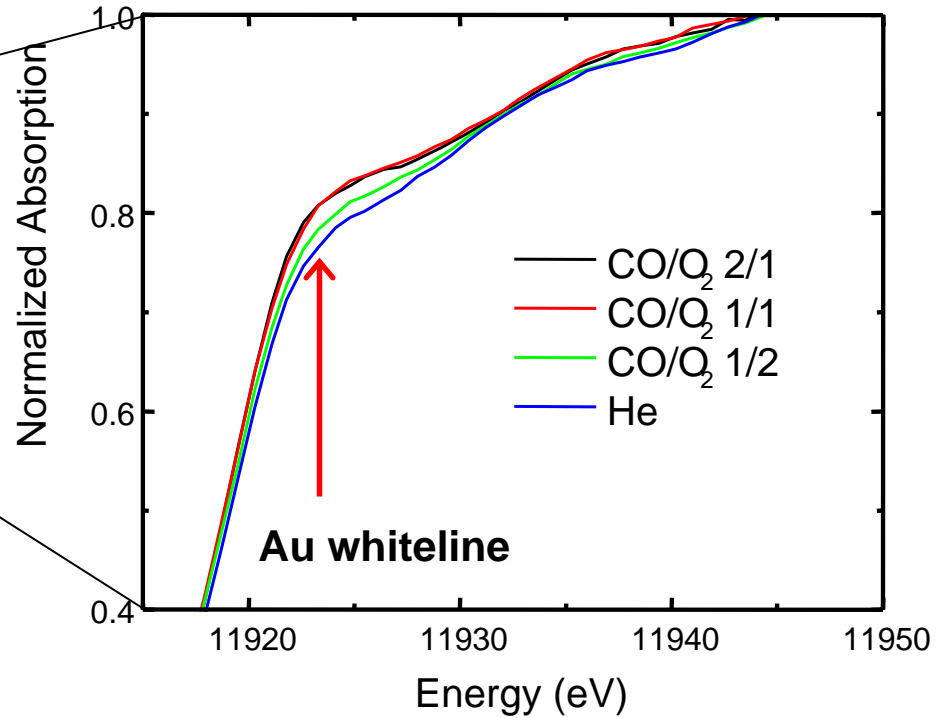
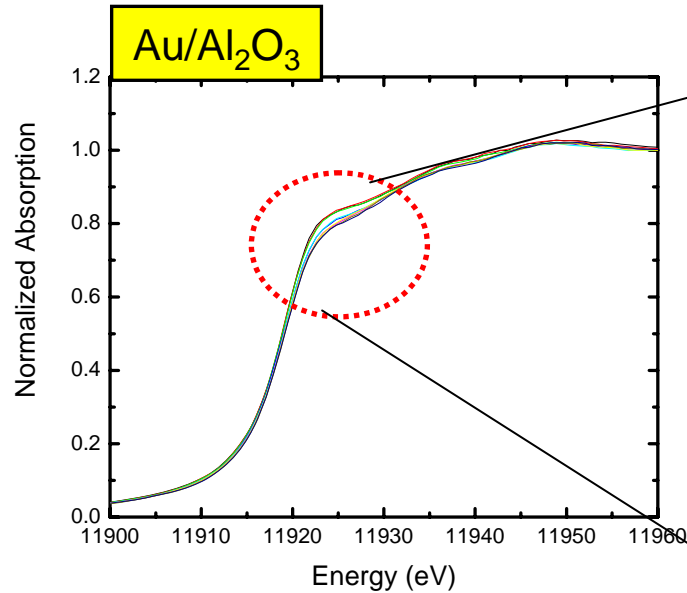

	CN(Au)	R(Au)
<b>He</b>	6.5	2.77
<b>1:1</b>	5.3	2.73
<b>2:1</b>	5.7	2.73
<b>1:2</b>	5.2	2.77

*Small oxygen contribution*

*More intense with more CO:  
holes in the d-band (anti-bonding states)*

# Gold catalysts and activation of oxygen

- Under (diluted)  $O_2$ : surface oxidation ( $Au/Al_2O_3$  &  $Au/TiO_2$ )
- Switch to  $CO/O_2$ : CO keeps gold reduced

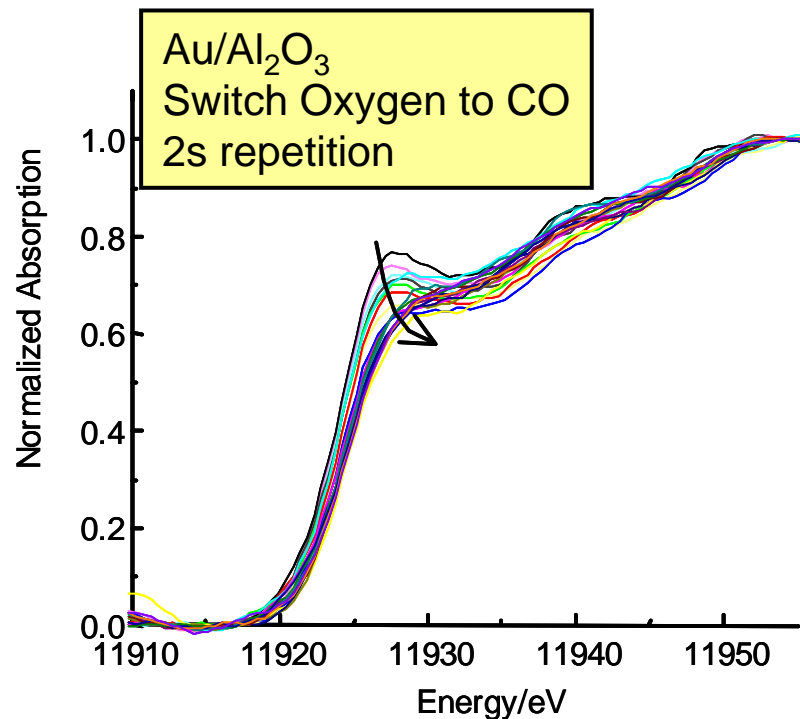

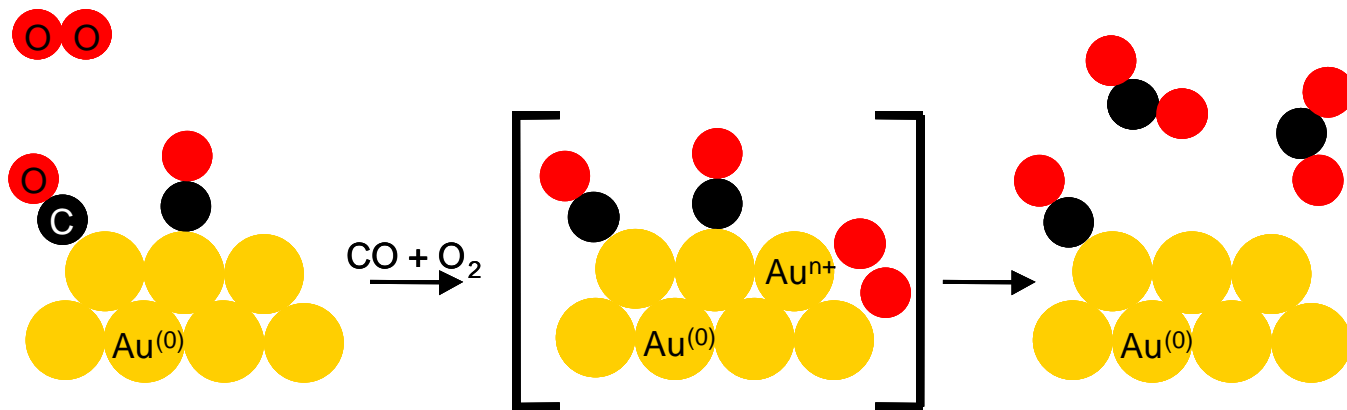
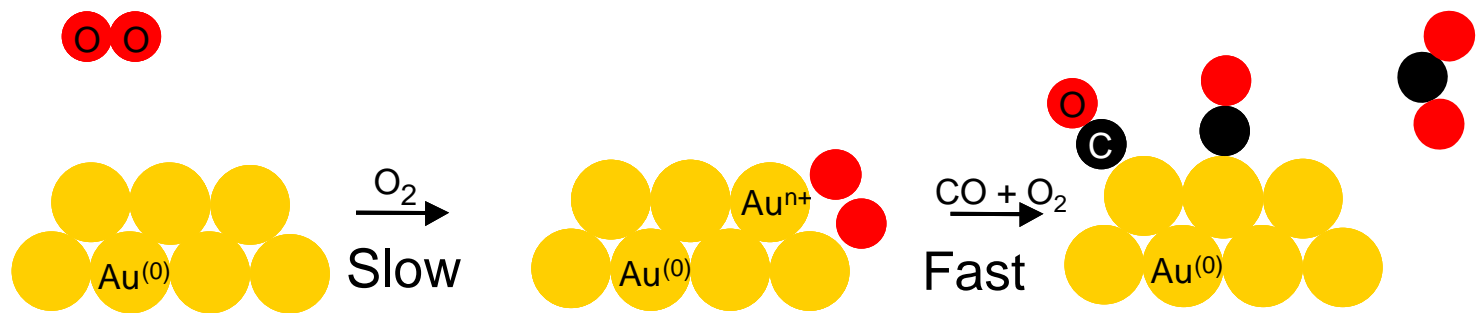

*Reduced gold is active phase*

*Gold participates in oxygen activation*

- Rehybridization of spd-orbitals ( $5d^{10-x}6sp^{1+x}$ )
- Smaller particles have fewer holes in the d-band
- Particle size dominates support-effect
- Oxygen is activated on gold particle

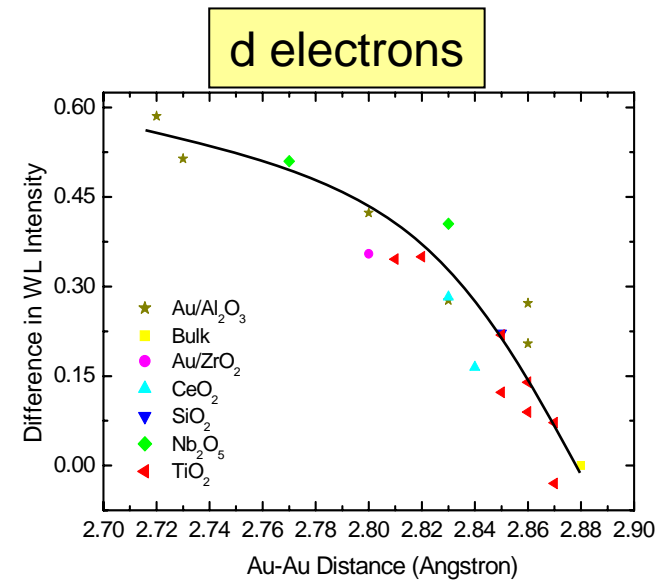
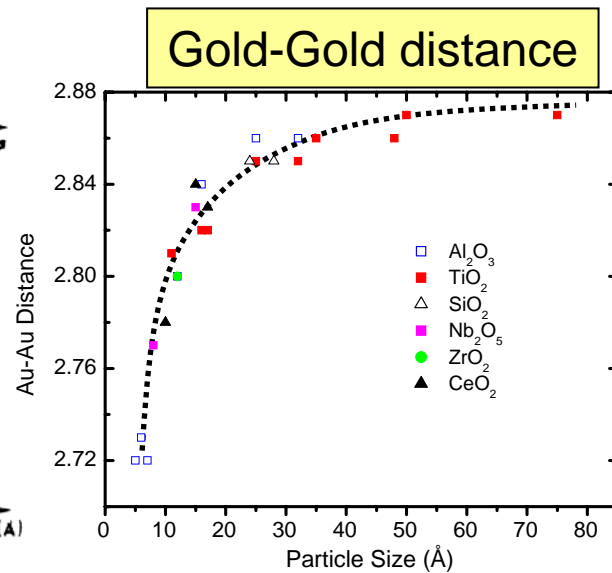
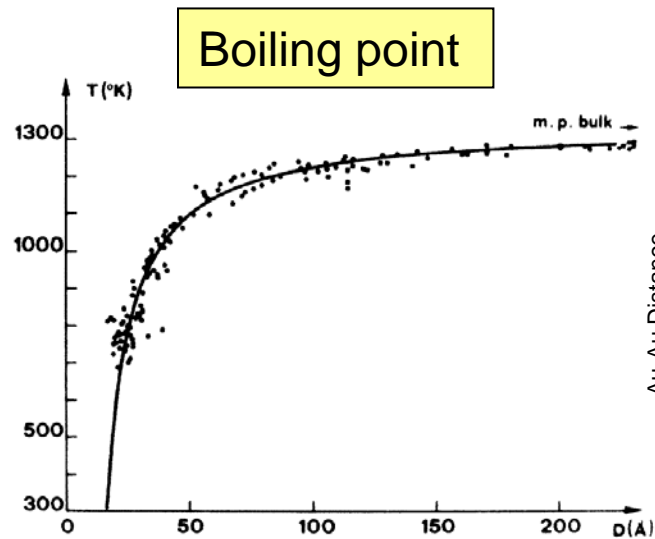
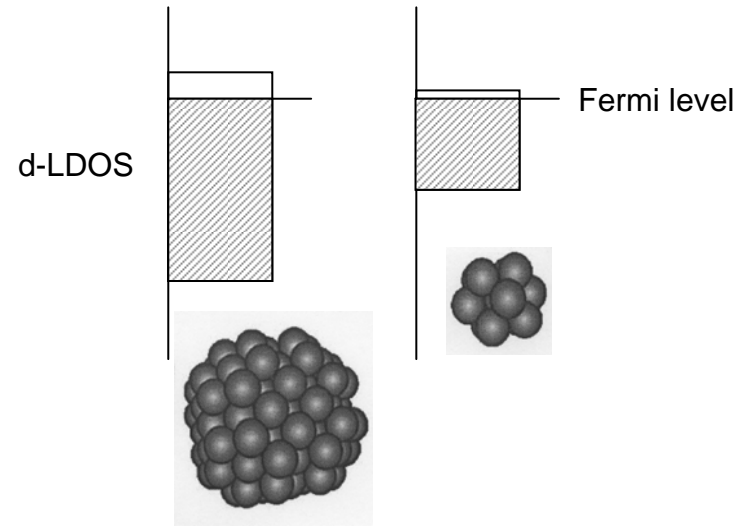

# Adsorption sites from XAS

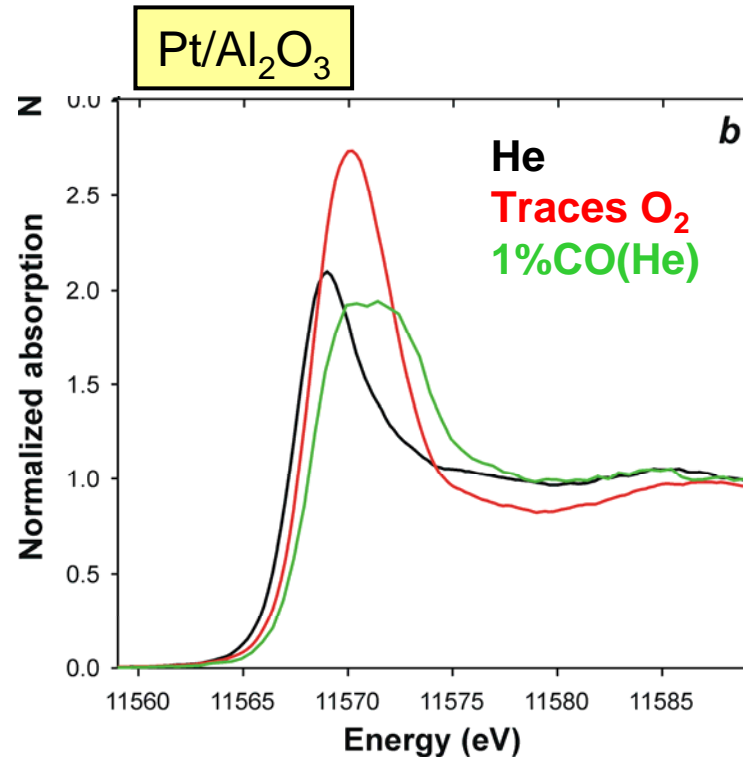

# FEFF8 simulation

Pt<sub>6</sub>CO atop

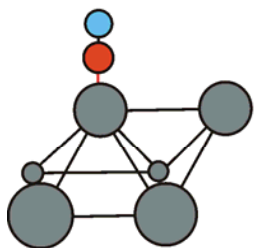

Pt<sub>6</sub>CO bridged

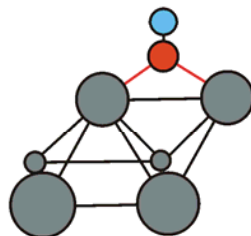

Pt<sub>6</sub>CO face bridging

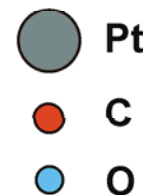
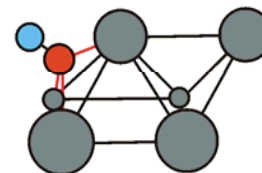

Experimental

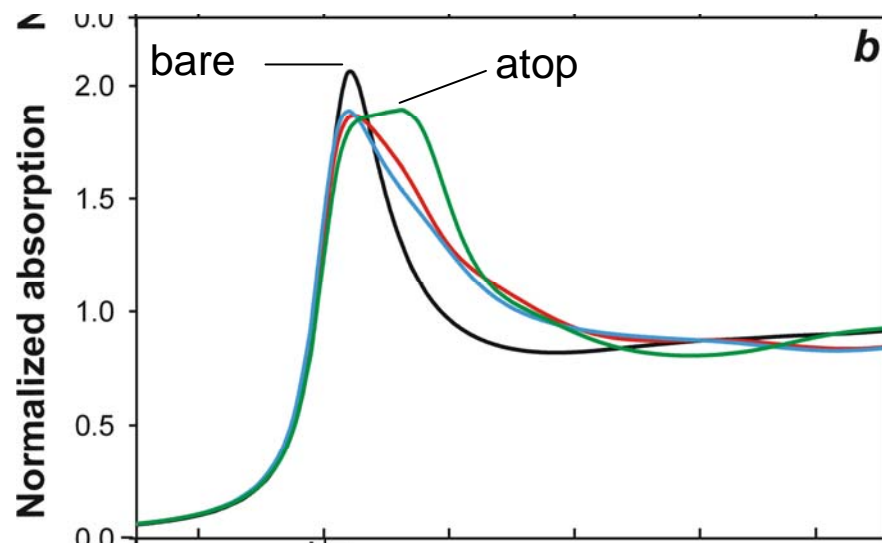
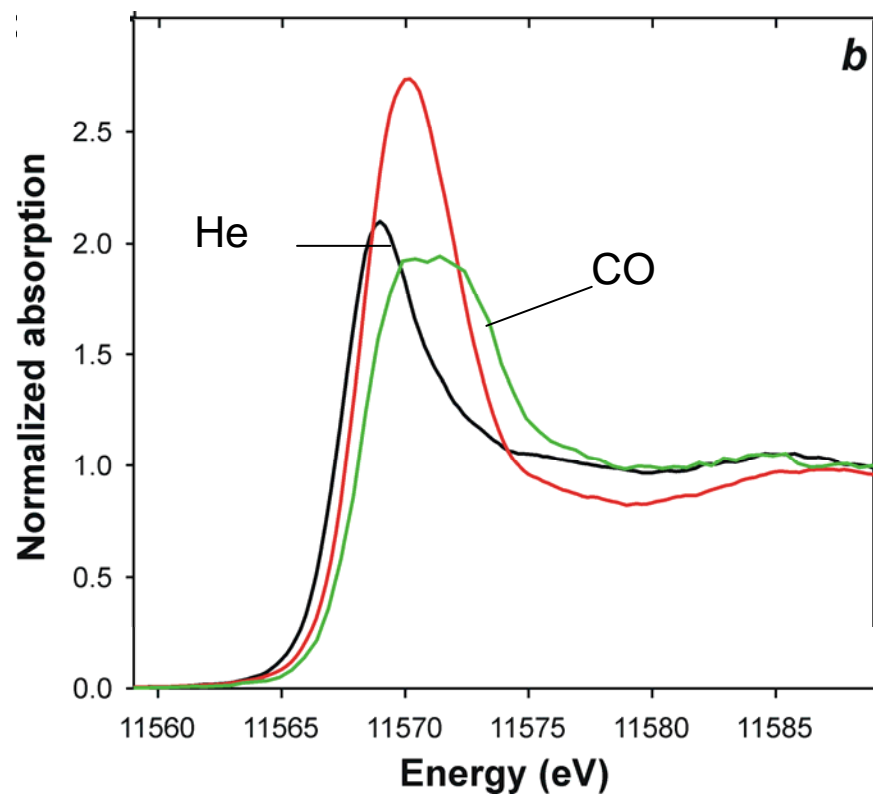





**fuel cell (PEM)**



**catalytic converter**



**platinum catalyst**

**Structure of the active phase?**

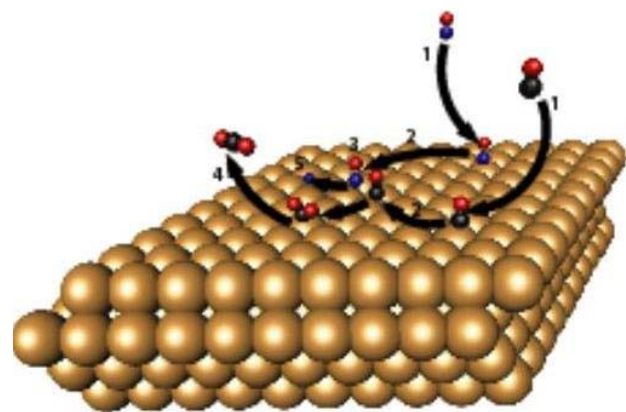

**surface reaction**



**surface patterns**

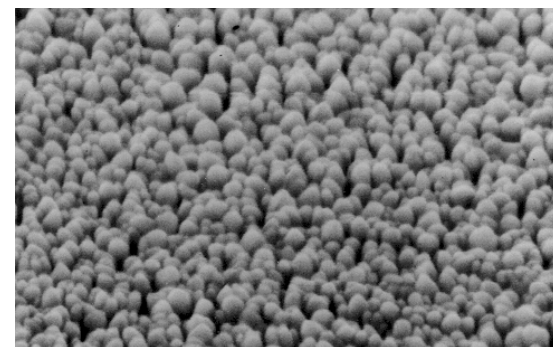

**surface roughening**

# Single Crystals

UHV conditions

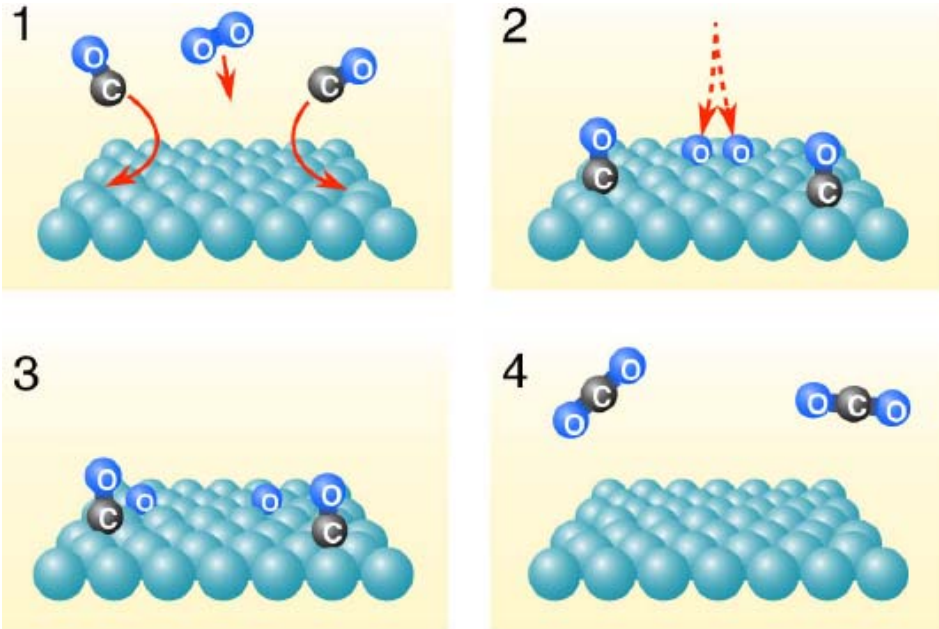

*Langmuir-Hinshelwood*

# Single Crystals

UHV conditions

high pressure

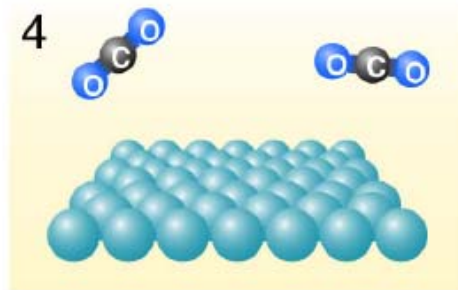
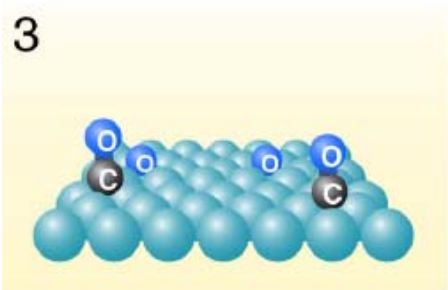
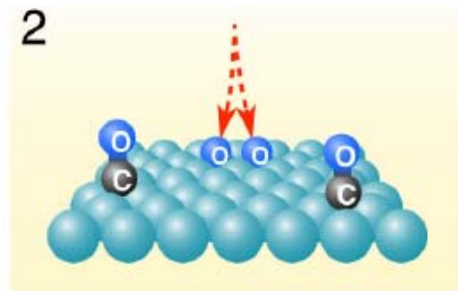
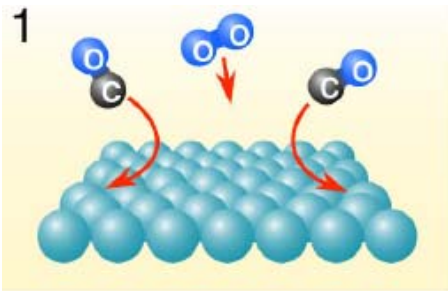

*Two reaction regimes*

- Low activity – CO poisoning

- High activity **???**

*Langmuir-Hinshelwood*

**material gap**

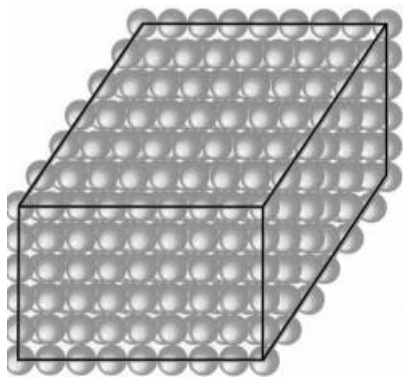

**Single Crystals**

**UHV conditions**

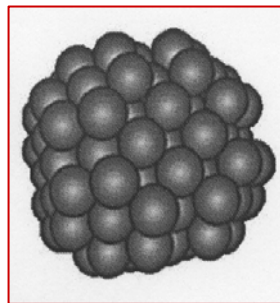

1.8 nm

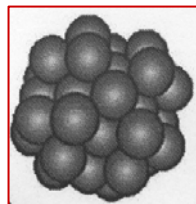

1.3 nm

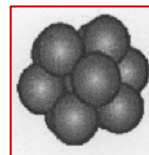

1 nm

**Real Catalysts**  
**Real Conditions**

**pressure gap**

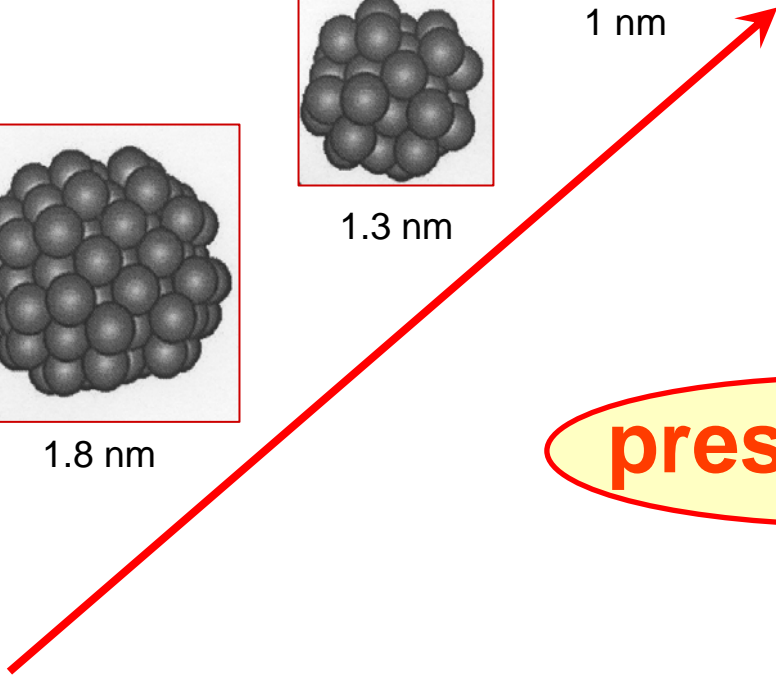

# Conversion data

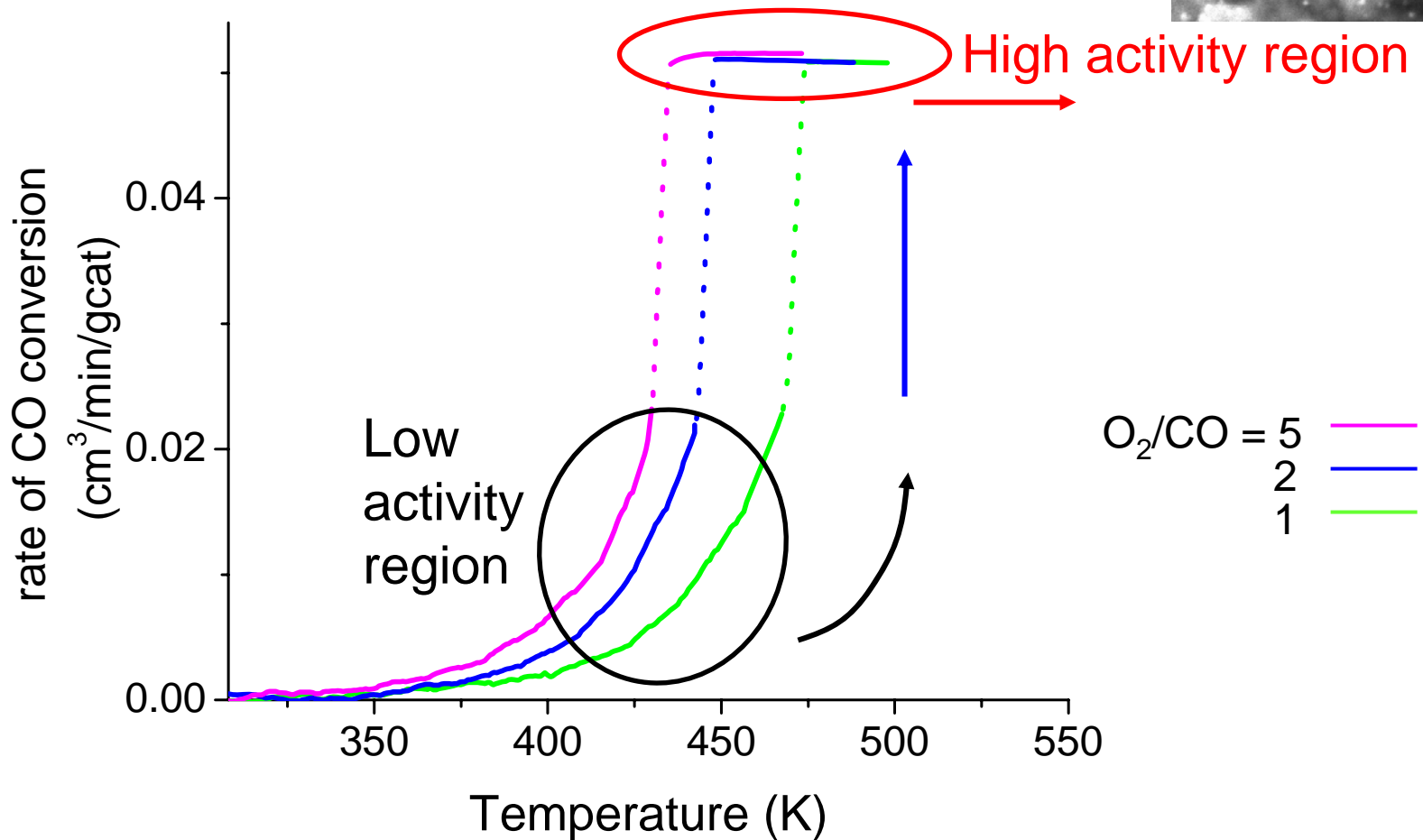
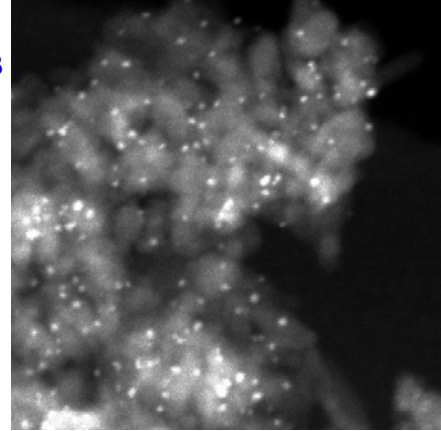

# Conversion data

O <sub>2</sub> /CO ratio	ignition or extinction temperature (K)		hysteresis	temperature for onset of conversion (K)
	heating	cooling		
1	472	456	yes	340
2	445	440	yes	338
5	433	421	yes	329

# XAS

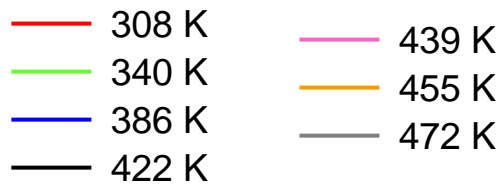
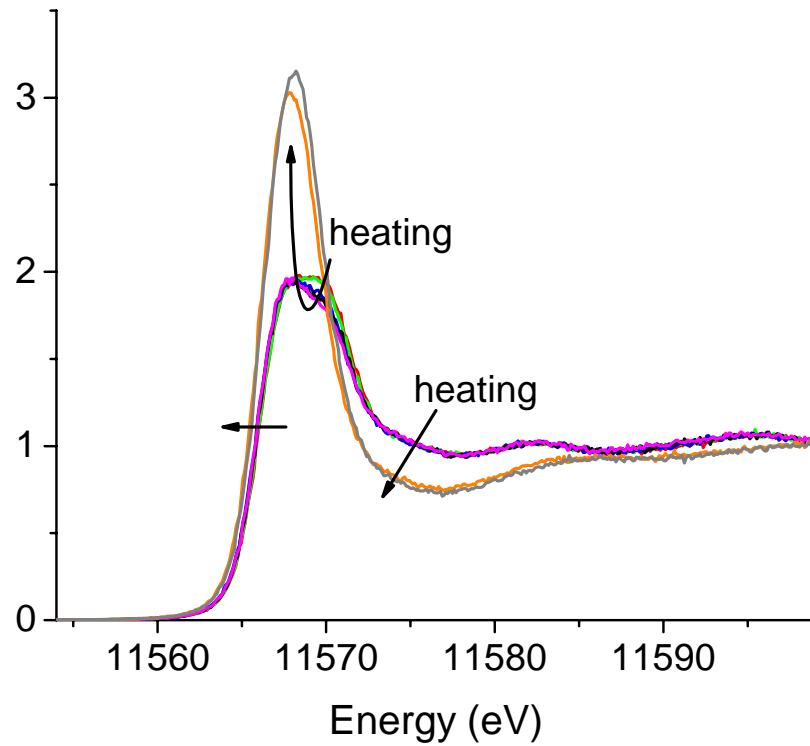

$O_2/CO = 2$

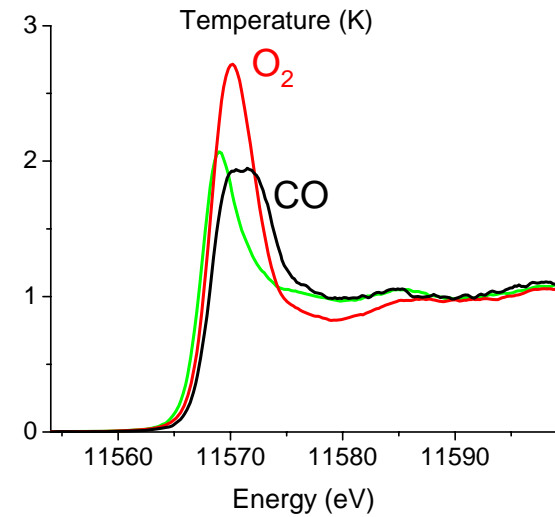
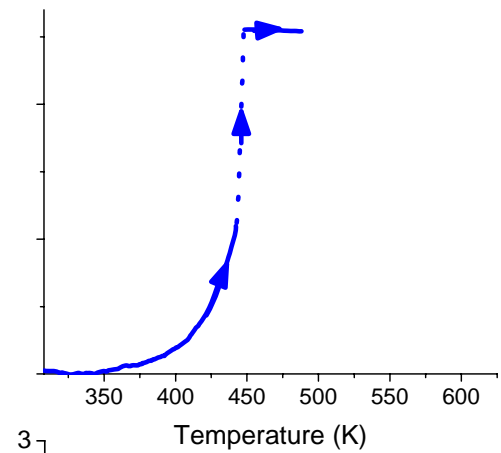

# XAS

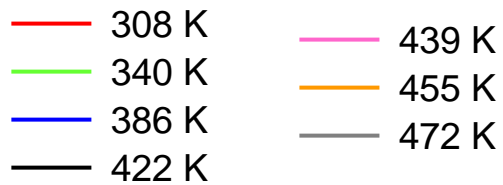
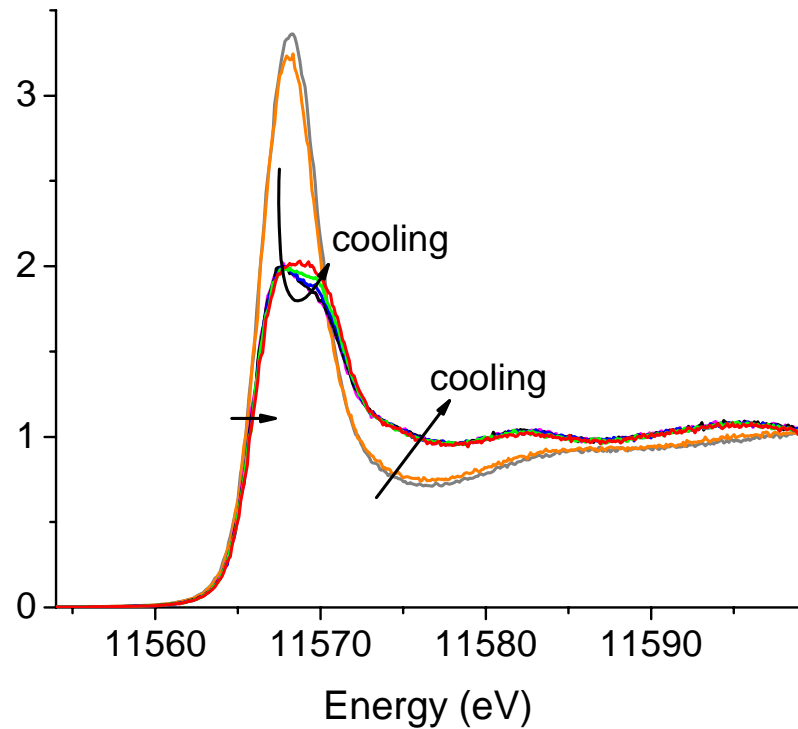

$O_2/CO = 2$

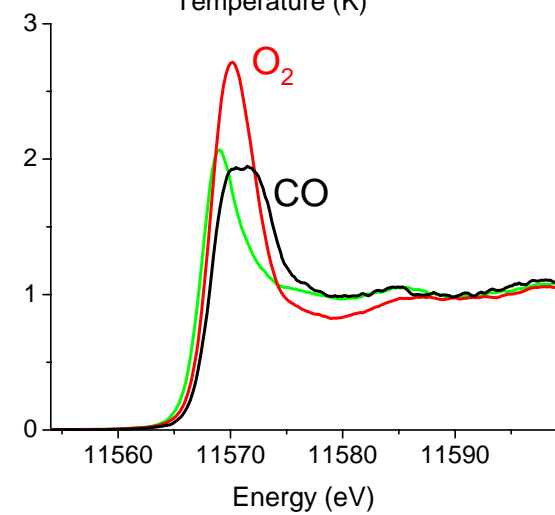
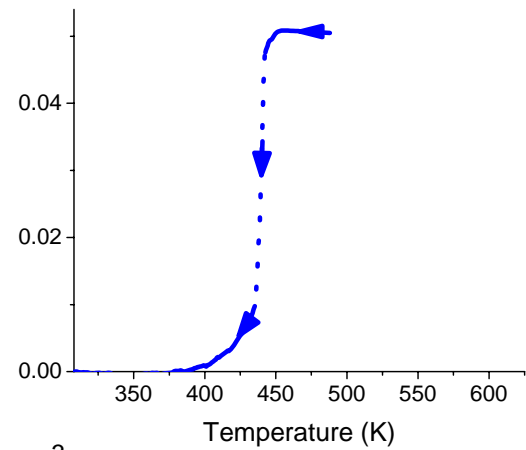



ratio  $O_2 / CO = 1$

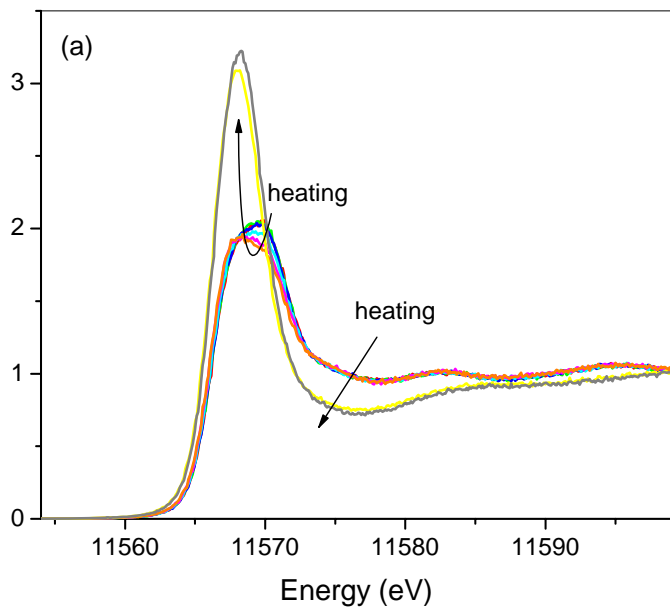

ratio  $O_2 / CO = 2$

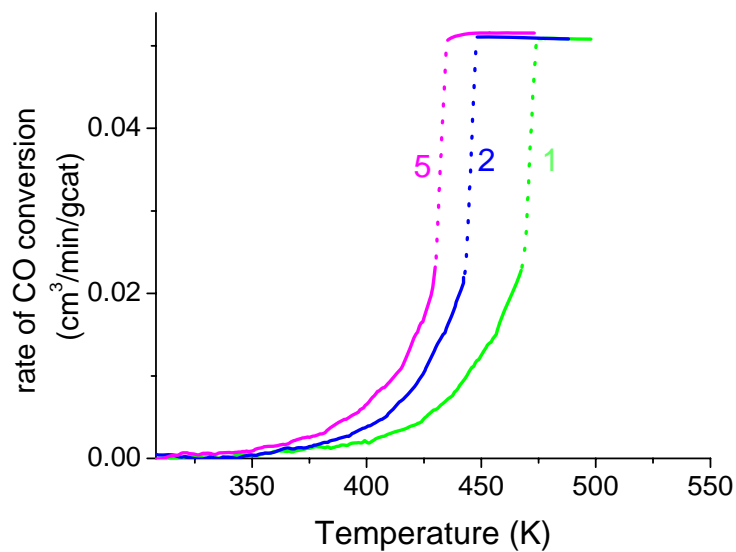
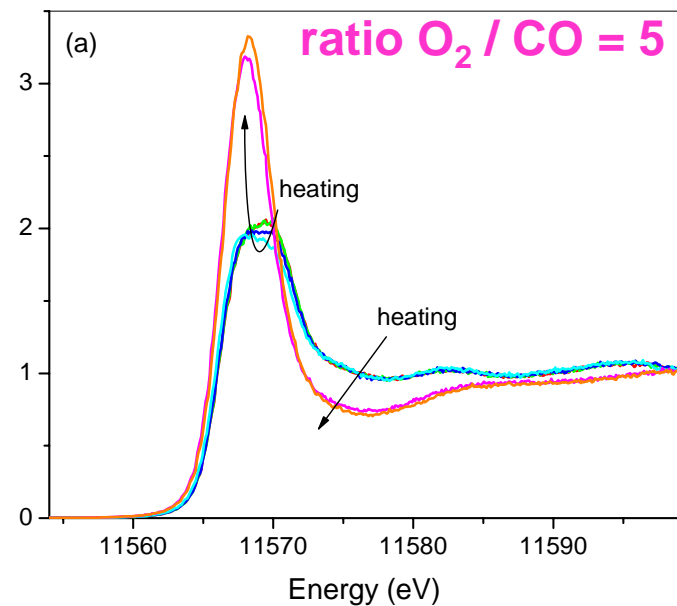
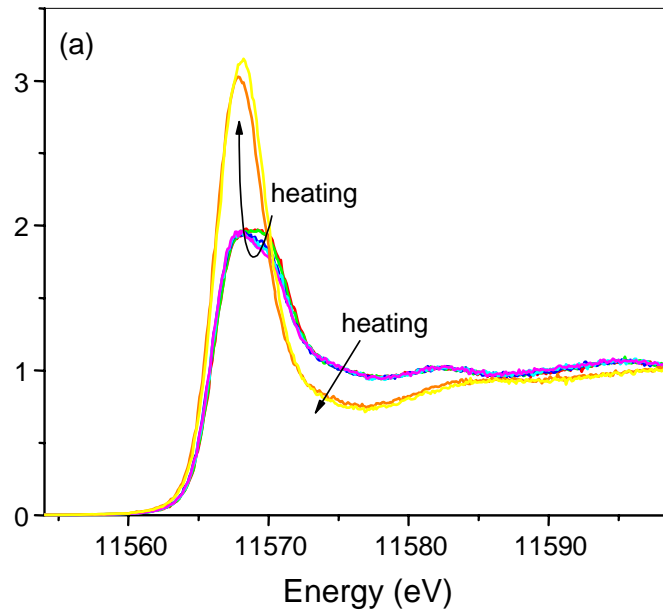

*oxidation parallels ignition*

# Kinetics and XAS

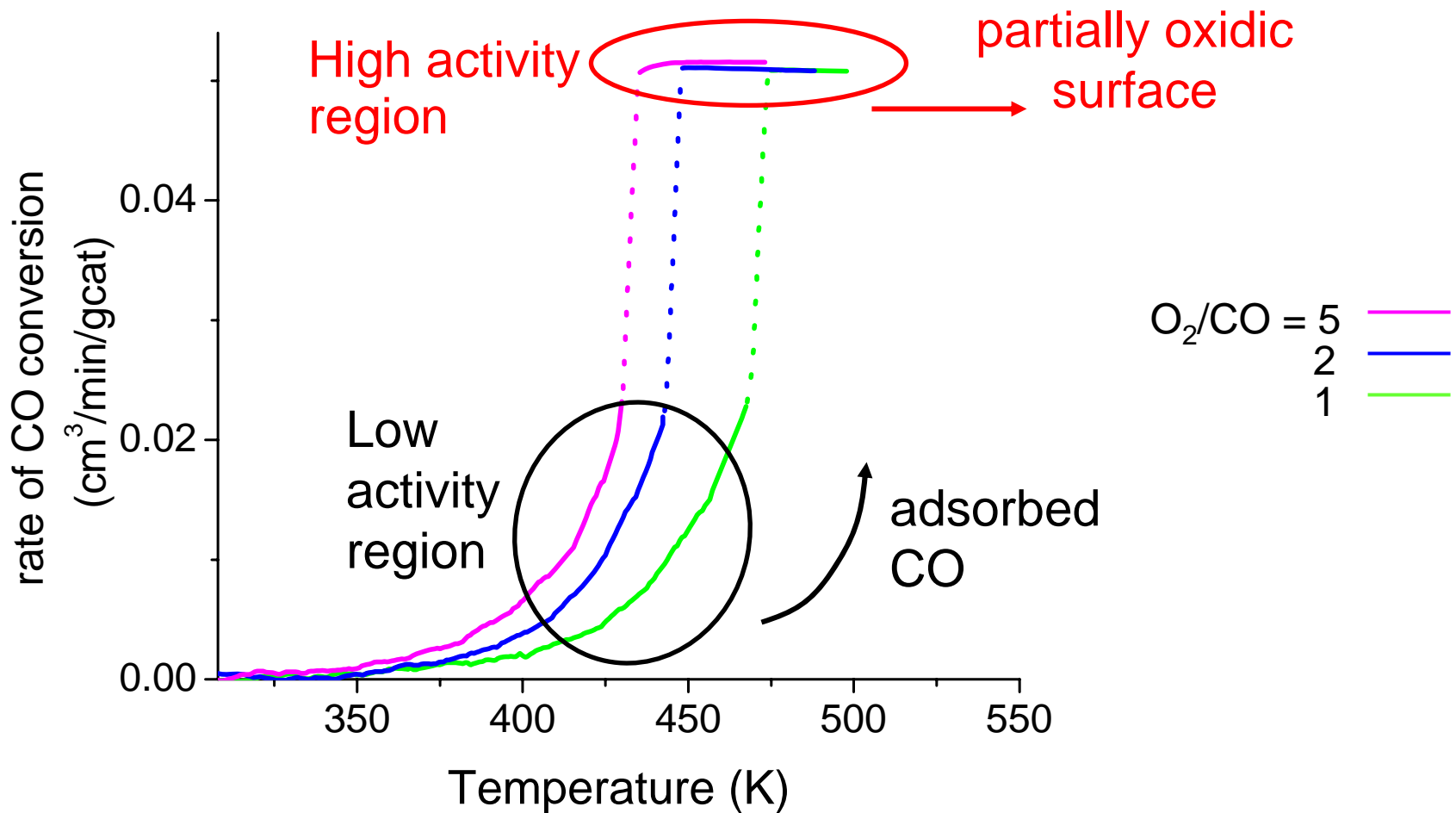

# Kinetics and XAS

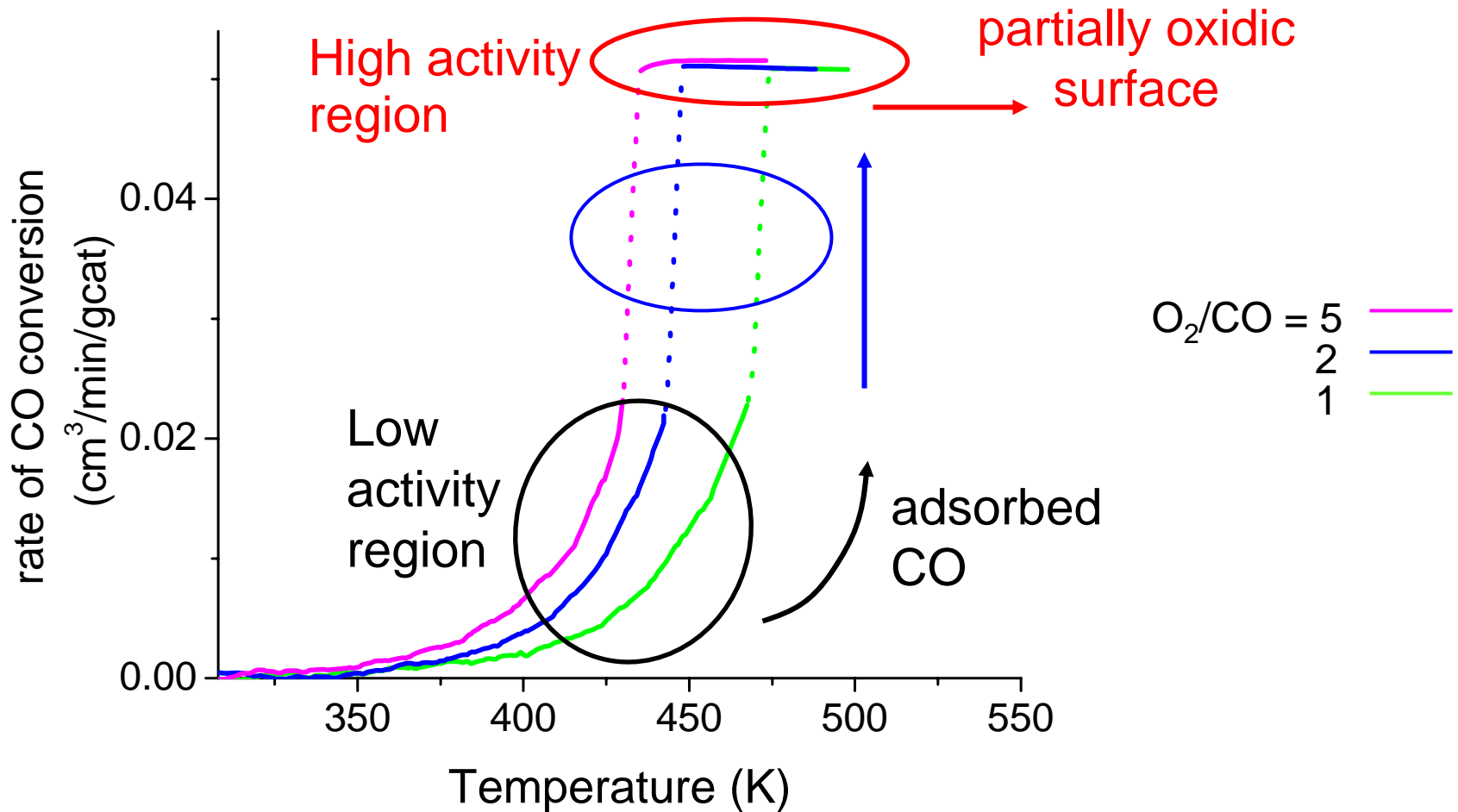

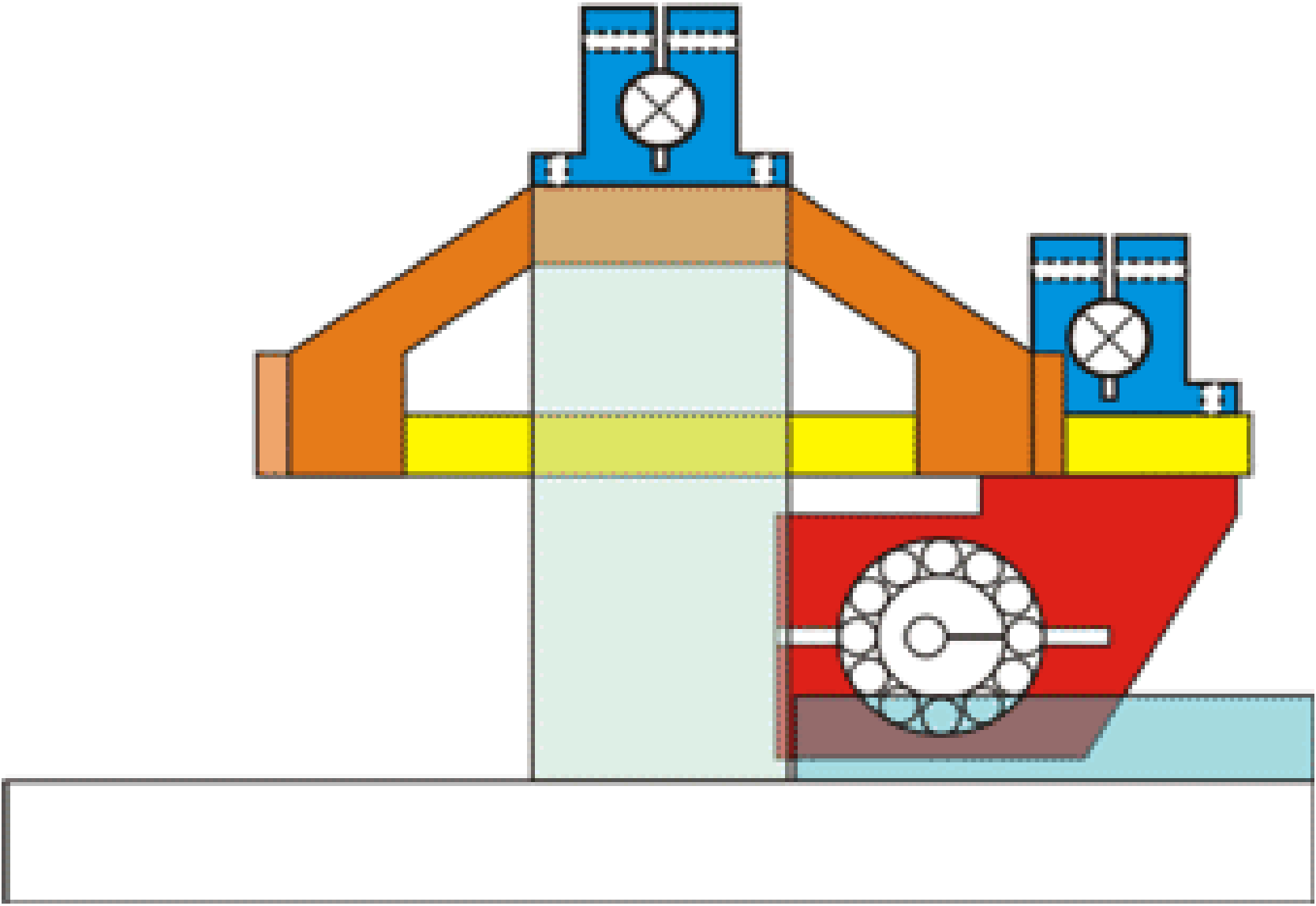

# Qexafs signals

Pt foil

L<sub>3</sub>, L<sub>2</sub>, L<sub>1</sub> edges

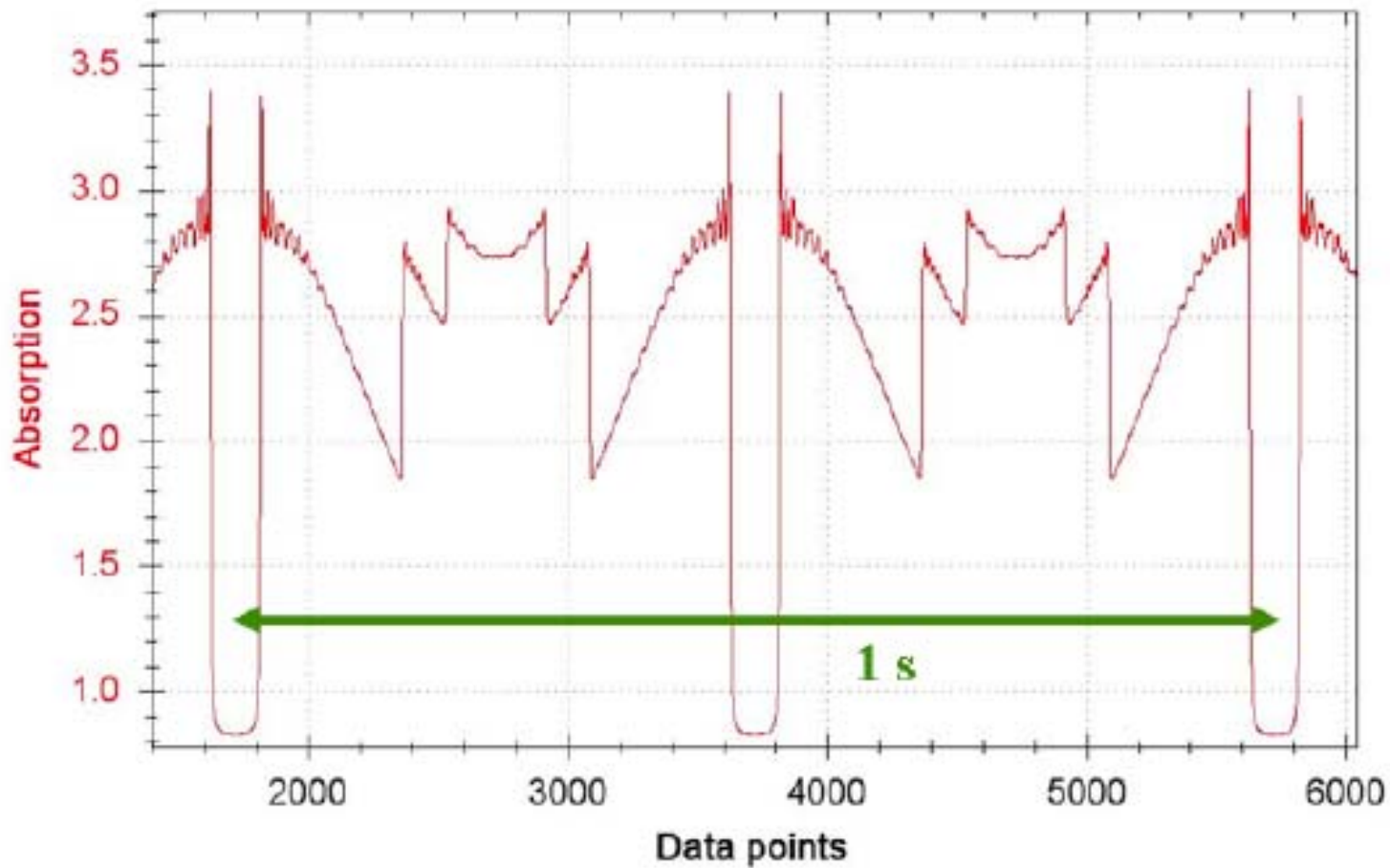
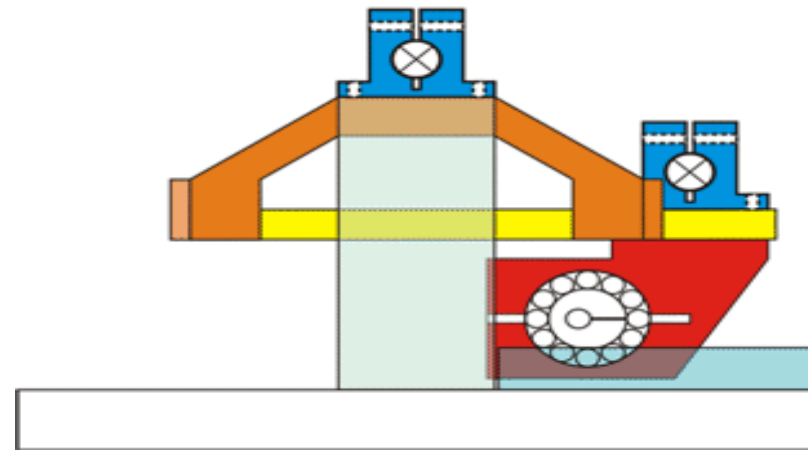

# XAS (QEXAFS)

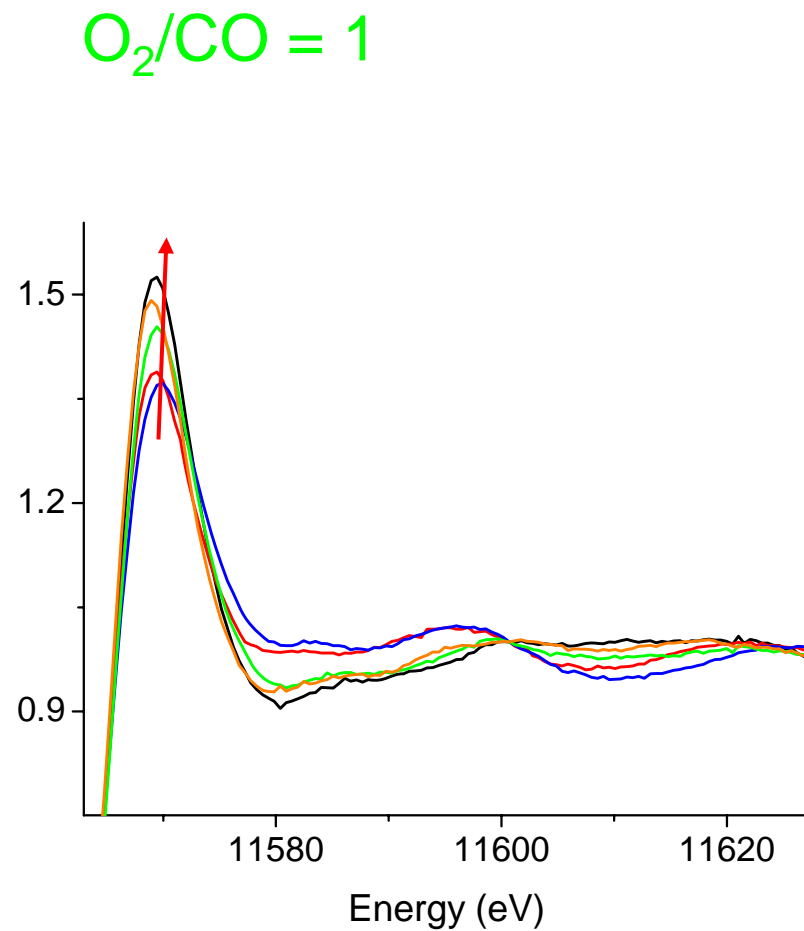
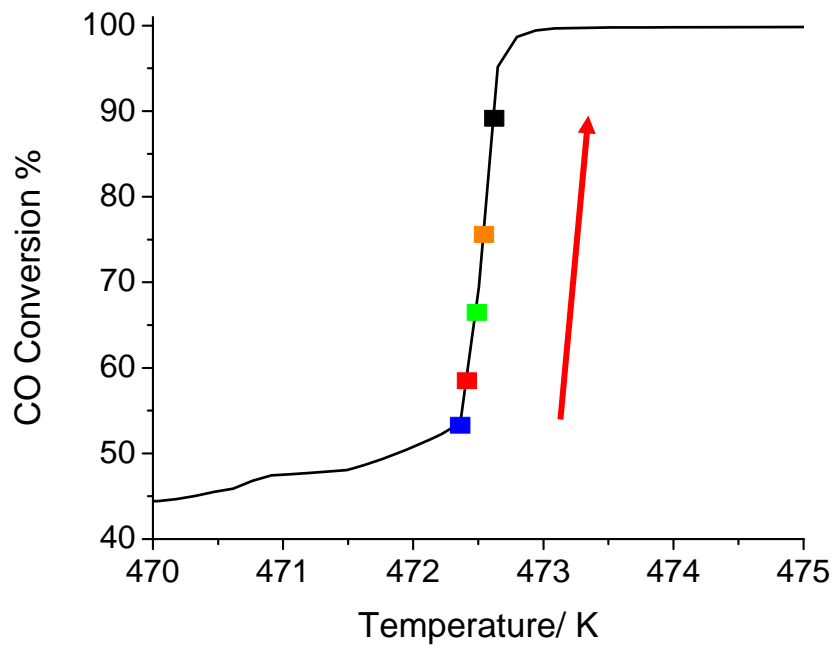

# Kinetics and XAS

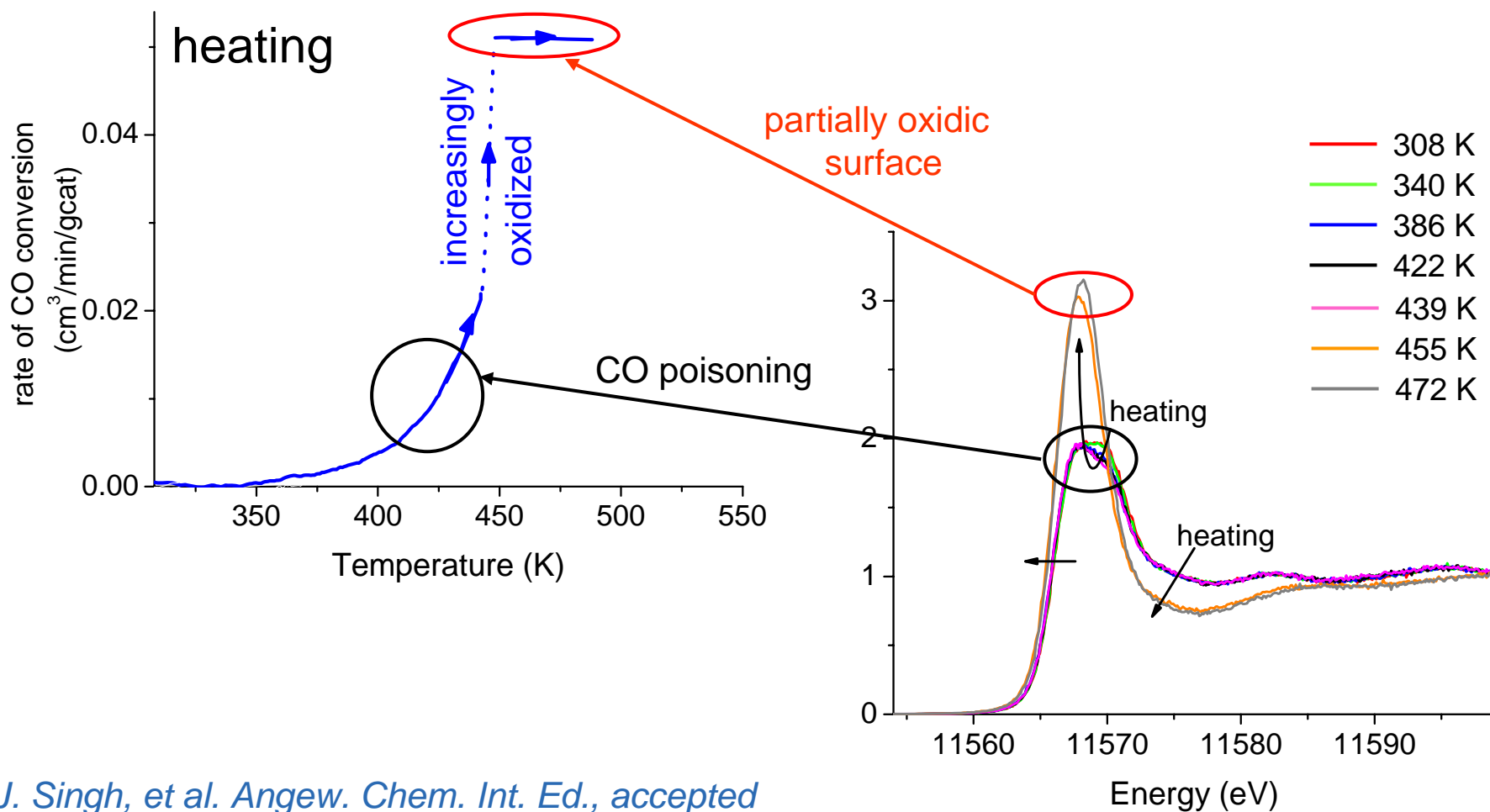

# Conclusions

- a highly active state of the catalyst is discovered
- the catalyst shows different structure in low- and high-activity regime; low-activity region : CO adsorbed on platinum, high-activity region: partially oxidized platinum
- the catalyst increasingly oxidizes during the ignition
- high temperature and a high oxygen concentration benefit the formation of the more active partially oxidic catalyst.



# Other supports (normal XAS)

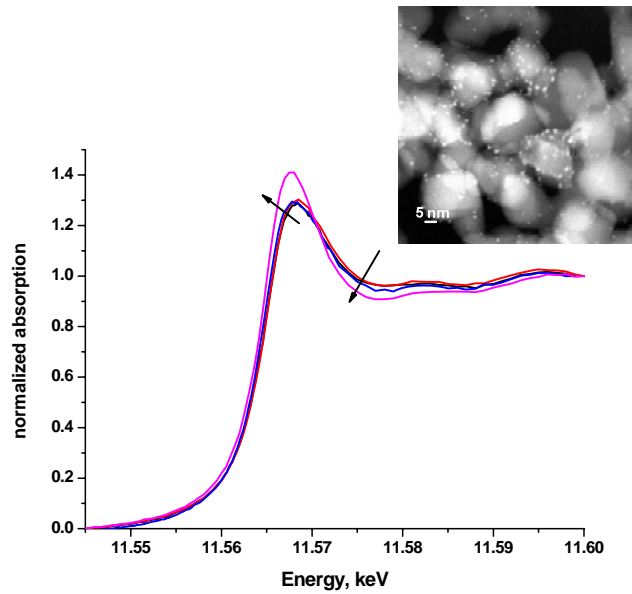
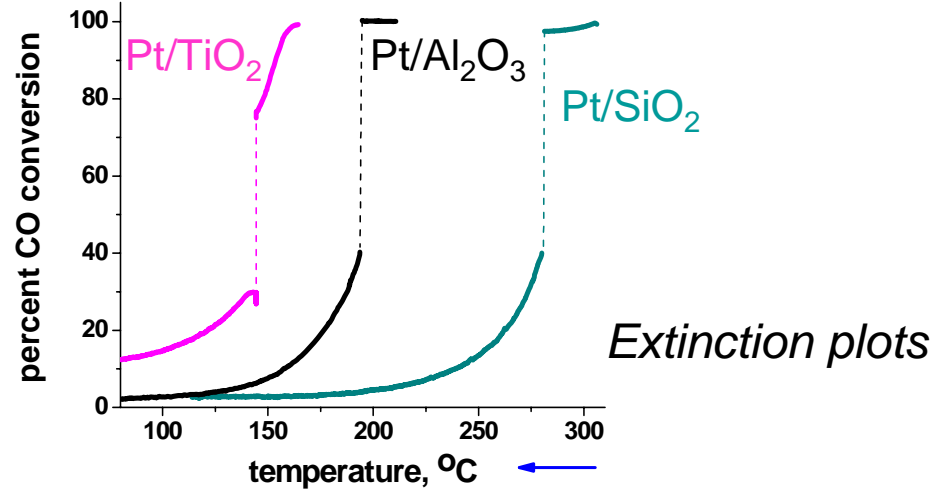

TiO<sub>2</sub>, 1.3 nm

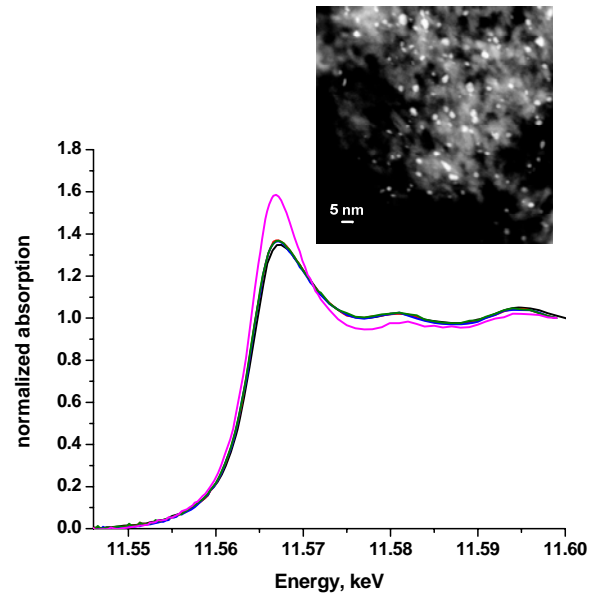

Pt/Al<sub>2</sub>O<sub>3</sub>L, 2 nm

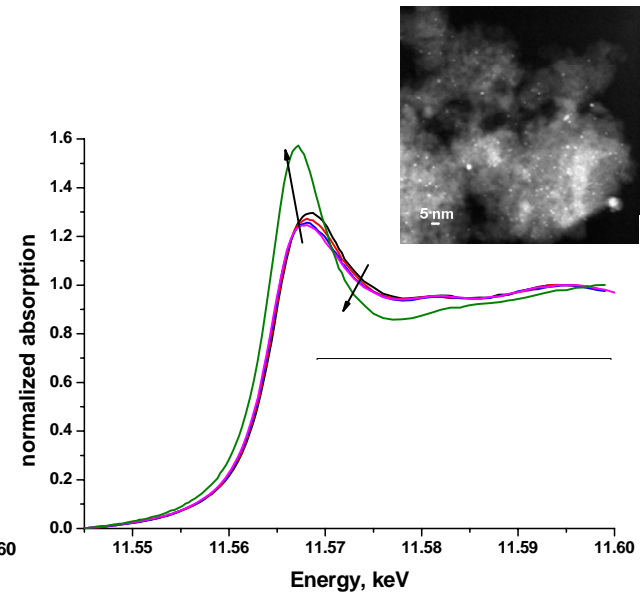

SiO<sub>2</sub>, 1.5-3 nm

# EXAFS analysis

## Below and above temperature of ignition

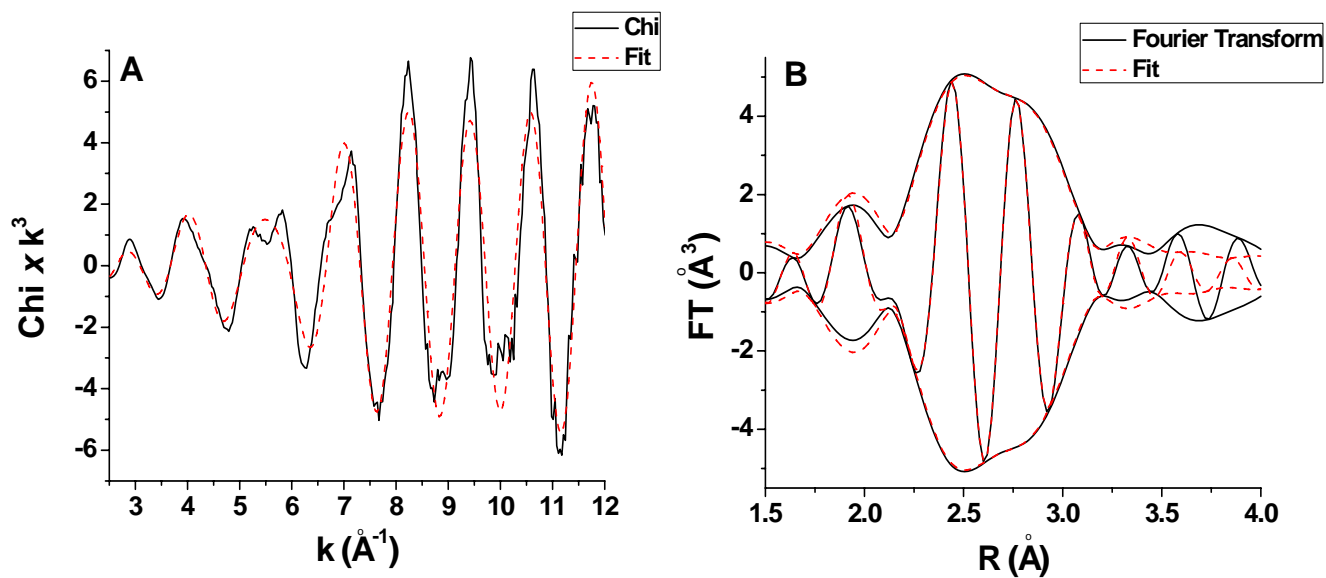

$k^3$  weighted CHI and Fourier transform

$2.5 < k < 12 \text{\AA}^{-1}$

Pt/ $\text{Al}_2\text{O}_3$ L reduced, hydrogen removed; He (RT)

# EXAFS analysis

Pt /Al<sub>2</sub>O<sub>3</sub> small particles

Conditions	atom	N	DW	R(Å)	E <sub>o</sub>
RT, He	Pt	5.7	0.0042	2.72	1.68
below ignition	Pt	6.2	0.0054	2.77	0.58
above ignition	O	2.4	0.0021	1.99	4.36
	Pt	3.0	0.0065	2.61	7.19
RT, O <sub>2</sub> /CO	Pt	5.6	0.0039	2.76	1.87

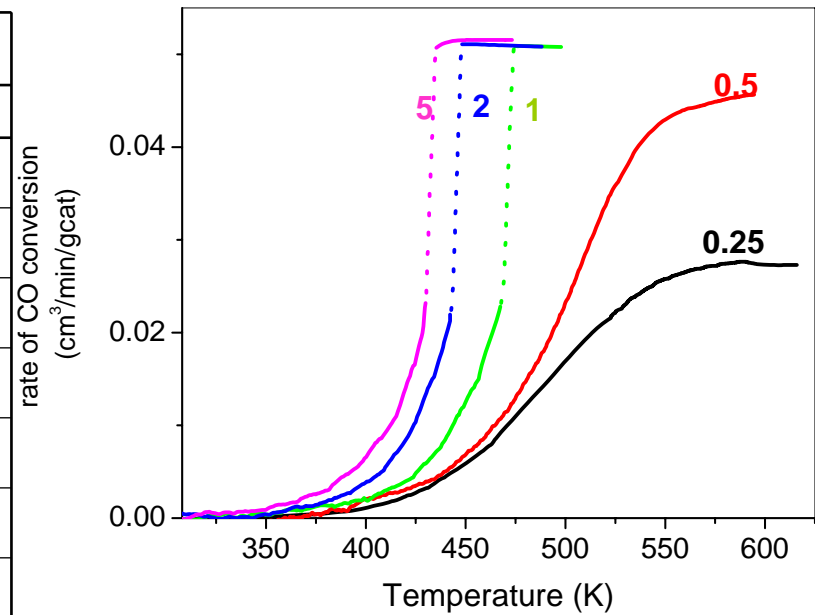

# Kinetic oscillations – Single Crystals

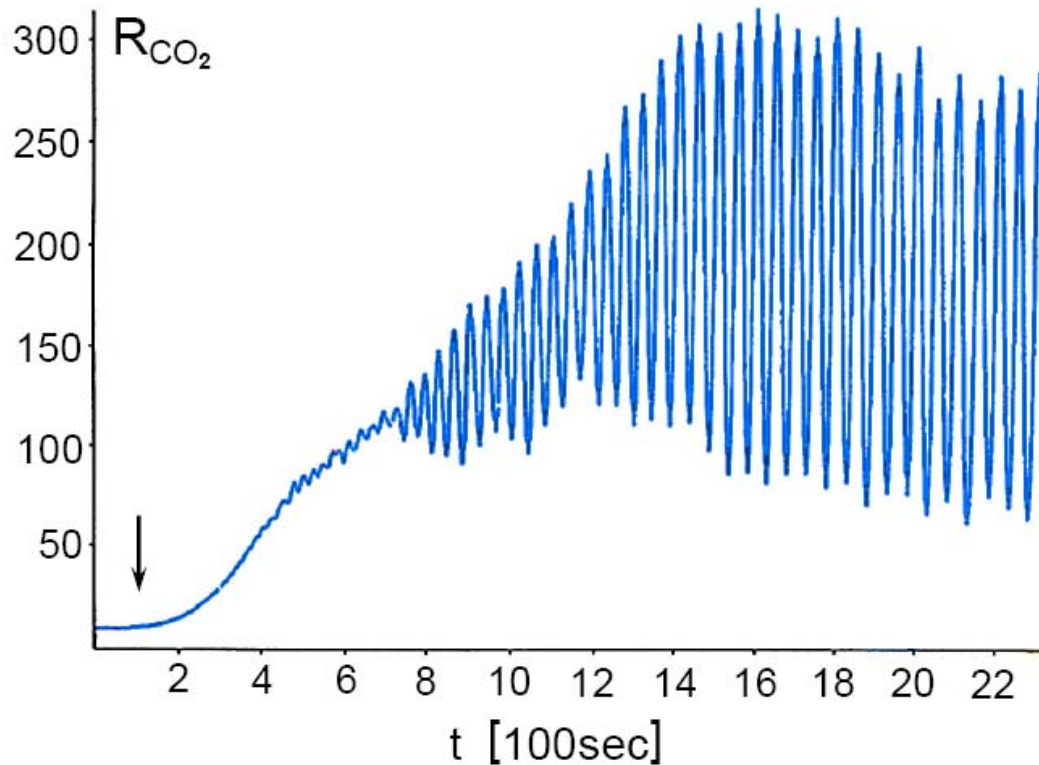

$T = 470\text{K}$   
 $p_{\text{CO}} = 3 \times 10^{-5} \text{mbar}$   
 $p_{\text{O}_2} = 2.0 \rightarrow 2.7 \times 10^{-4} \text{mbar}$

**Pt (110)**

# Kinetic oscillations – Single Crystals

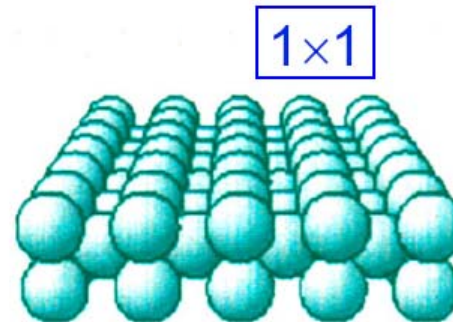
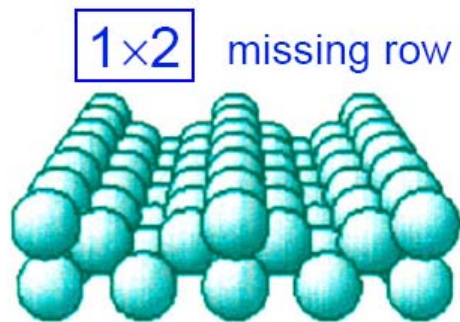

**bulk crystal  
plane**

**Pt (110)**

# Kinetic oscillations – Single Crystals

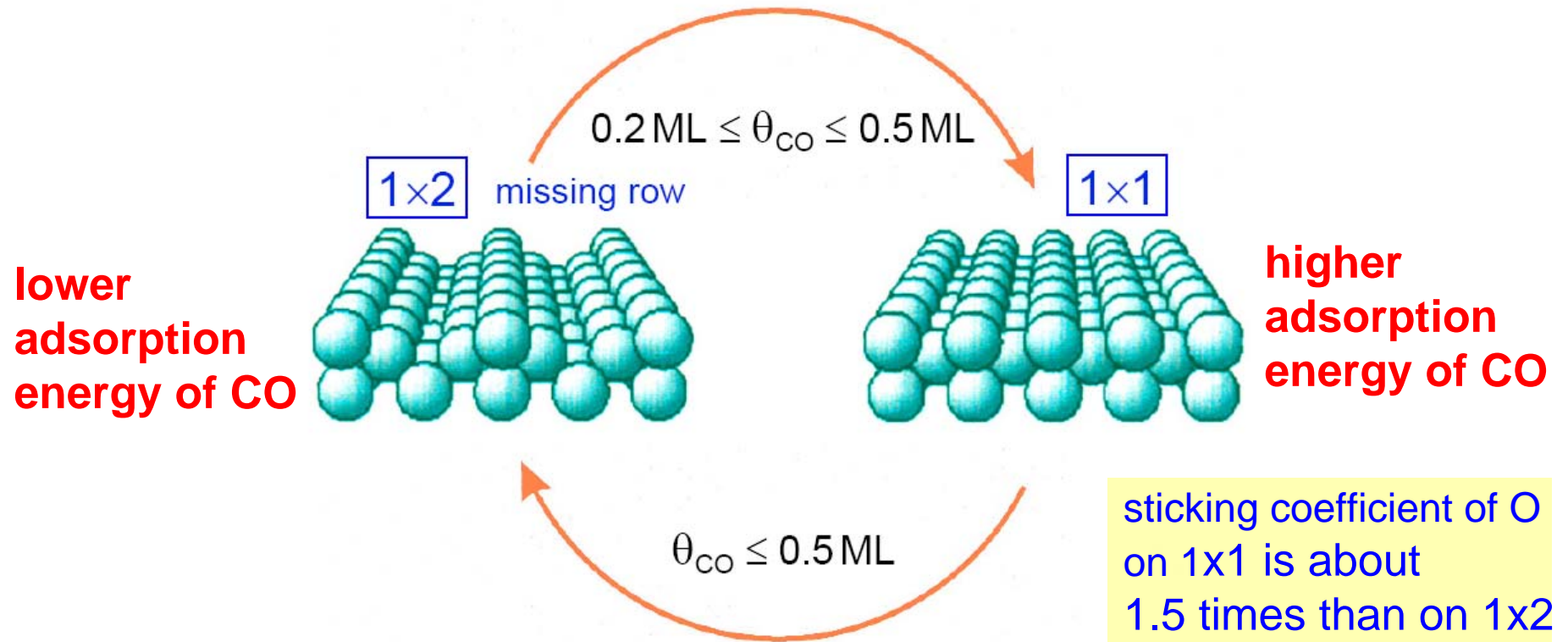

*T. Gritsch et al. Phys. Rev. Lett. 63 (1989) 1086*  
*N. Freyer et al. Surface Sci. 166 (1986) 206*

# Kinetic oscillations - 2wt% Pt/Al<sub>2</sub>O<sub>3</sub>

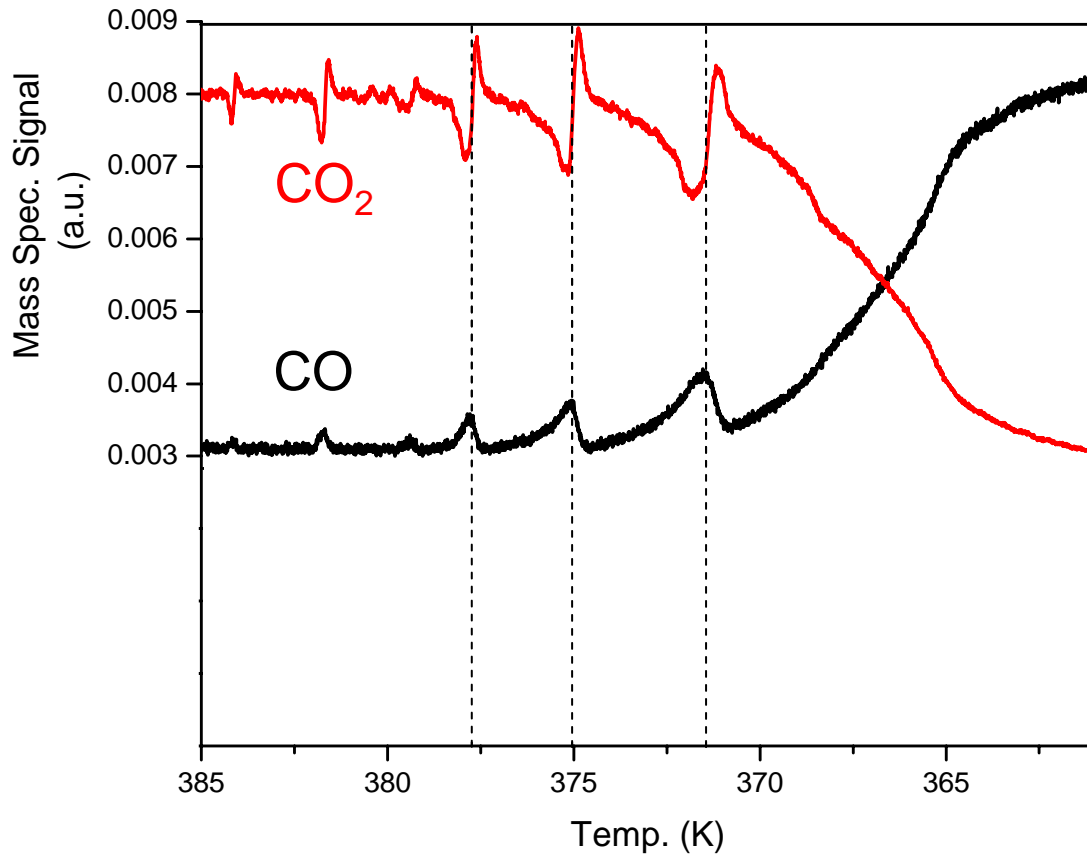

- storage of CO that is released in sudden spike of CO<sub>2</sub>
- CO poisoning; activity inversely proportional to adsorbed CO

# Kinetic Oscillations and QEXAFS

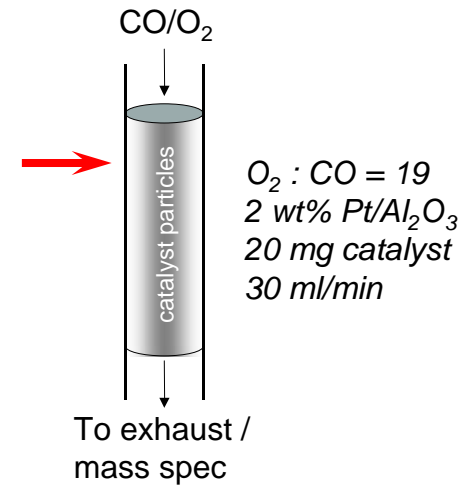
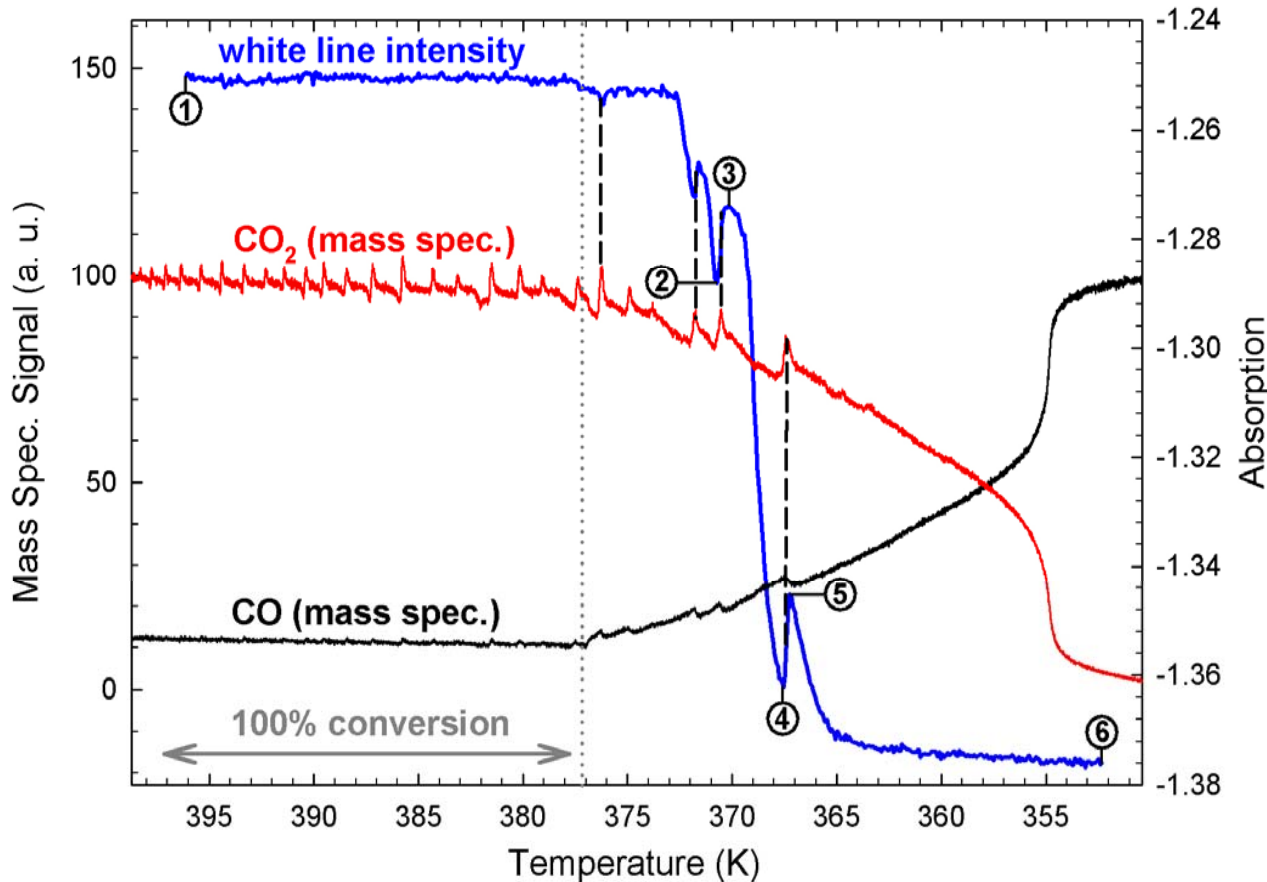

- activity loss due to reduction of active (oxidized) surface
- sudden increase in activity parallels oxidation of surface



kinetic oscillations originate from  
the reduction and re-oxidation  
of the surface

Best of luck for your exams 😊

# Data Analysis: Statistical Considerations

---

R-Factor

Absolute misfit between data and theory

$\chi^2$

Function minimised in fitting algorithms

red  $\chi^2$

minimised function scaled by degrees of freedom

$$N_{ind} = \frac{2 \cdot \Delta k \Delta R}{\pi} + 1$$

**EXAFS error margins:**

$N \pm 0.5$             20%

$R \pm 0.01 - 0.03$

$\sigma^2 \pm 20\%$