



Eidgenössische Technische Hochschule Zürich
Swiss Federal Institute of Technology Zurich

Security of Wireless Networks

Lecture 2

Srdjan Čapkun

(delivered by Aanjhan Ranganathan)

Department of Computer Science

ETH Zurich

Secure Proximity Verification

Example: PKES

(deployed by all major car manufacturers)

PKES: Key is “in pocket” - car opens when the key is *close to the car*

- *Relay attack [FrancillonNDSS11]*

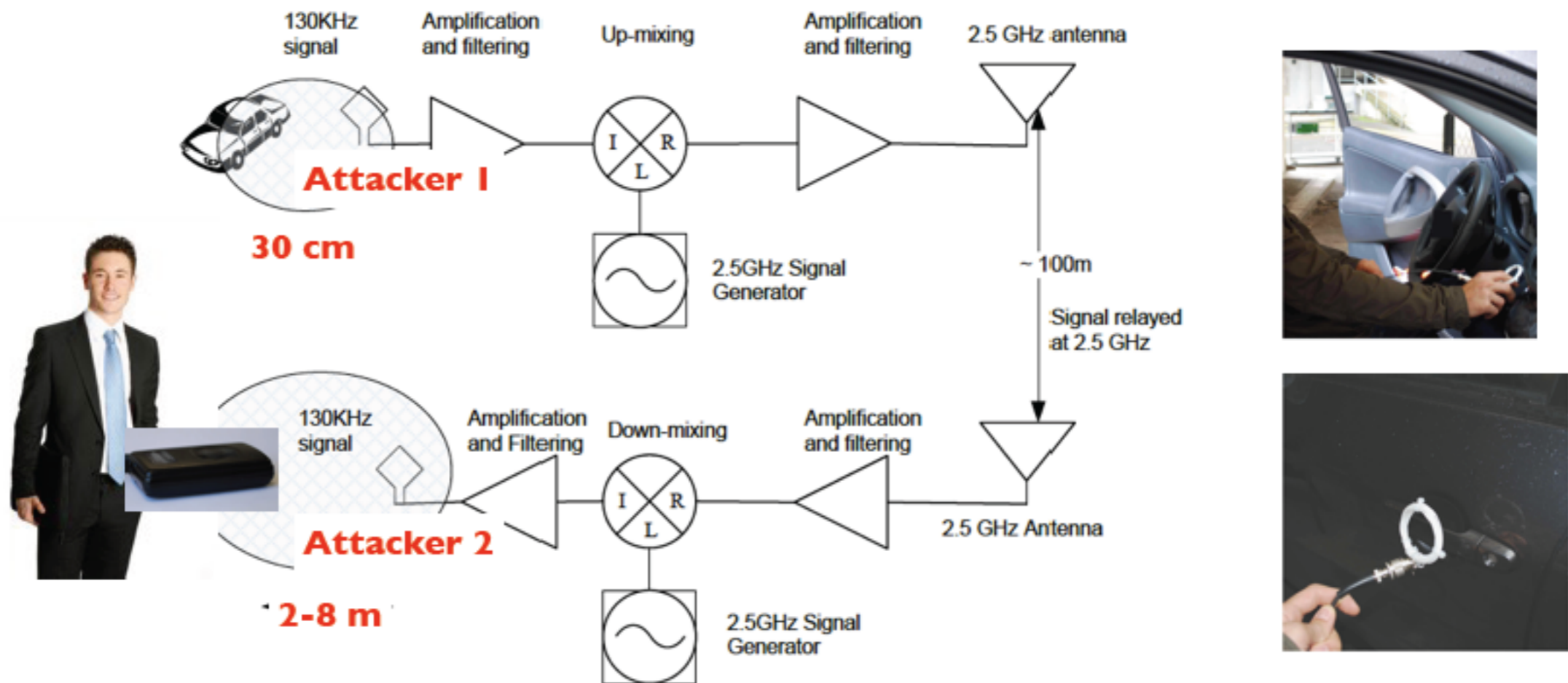

- Tested on 10 car models from 8 manufacturers
- Manufacturers are now redesigning Entry and Start Systems

Example: RFID / NFC communication

Do LF/HF RFID/NFC systems provide guarantees on the communication range?

- HF RFID, ISO 14443 and ISO 15693 [Hancke10]

Legitimate System

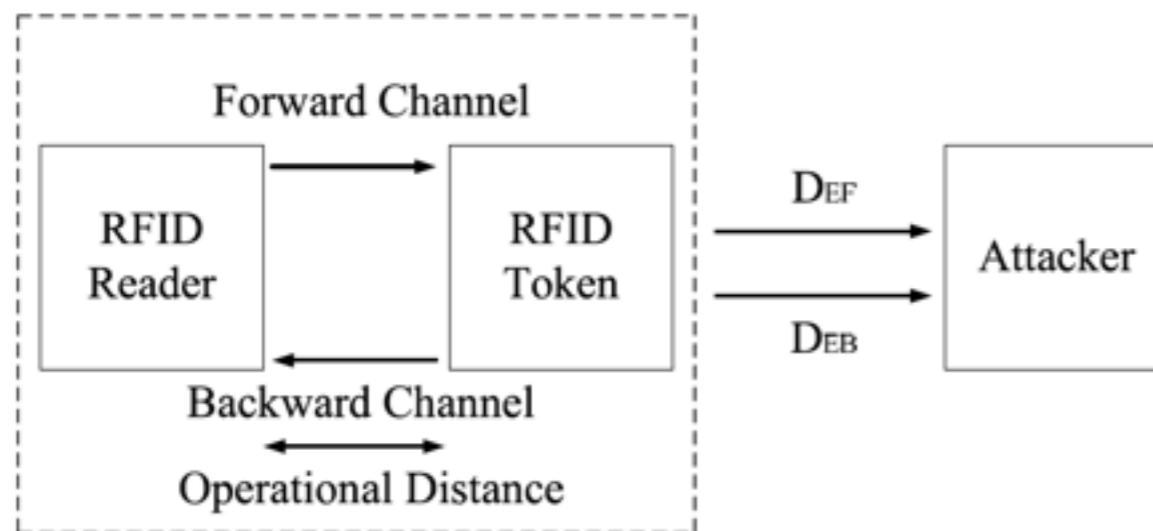

	ISO 14443A	ISO 14443B	ISO 15693
Entrance hall			
1 m	FB	FB	FB
2 m	FB	FB	FB
3 m	Fx	xB	Fx
4 m	Fx	xx	Fx
5 m	Fx	xx	Fx
Lab corridor			
1 m	FB	FB	FB
2 m	FB	FB	FB
3 m	FB	FB	Fx
4 m	Fx	xB	Fx
5 m	Fx	xx	Fx

Table 1: Eavesdropping results: F – Forward channel recovered, B – Backward channel

Secure Proximity Verification?

Secure Proximity Verification

- Inductive Coupling
- Radio Communication

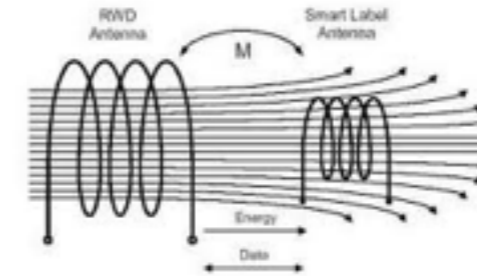

*Communication DOES NOT imply physical proximity.
(in adversarial environments)*

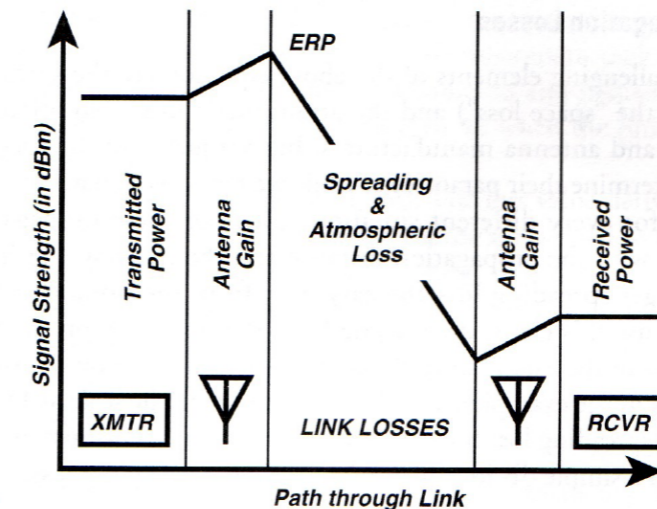

To calculate the received signal level (in dBm), add the transmitting antenna gain (in dB), subtract the link losses (in dB), and add the receiving antenna gain (in dB) to the transmitter power (in dBm).

©D. Adamy, A First Course on Electronic Warfare

As shown in PKES systems, relying on the reduced communication range is either not convenient or not secure.

- *We need a difficult problem to hold on to.*

Solution: Secure Proximity Verification **using secure ranging.**

Secure Proximity Verification

One (untrusted) device wants to *prove to be close* to another device.

- e.g., if a reader is close to the pacemaker, it gets access, otherwise it does not

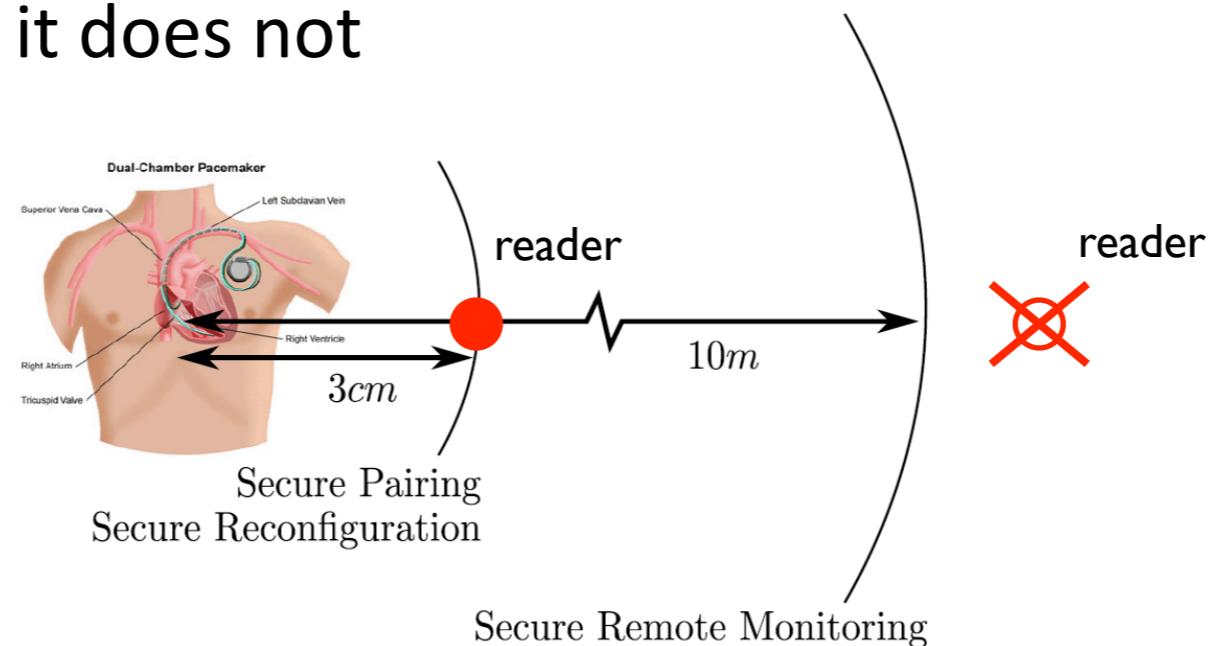

Two devices want to *verify if they are indeed close*.

- e.g., a car and a key want to verify if they are physically close

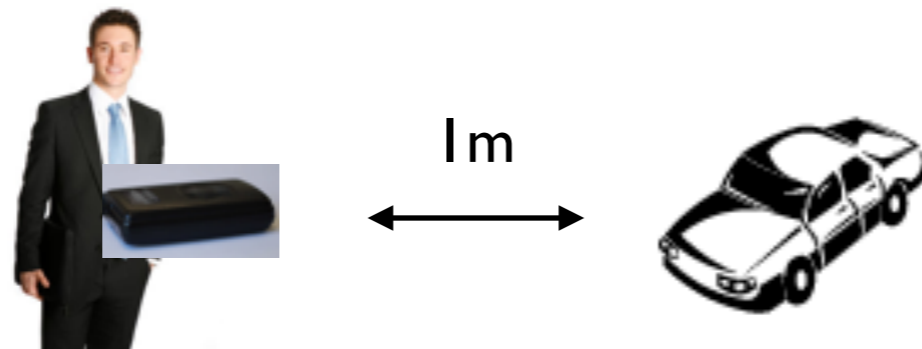

Distance Bounding [BrandsChaum93]

Basic Idea

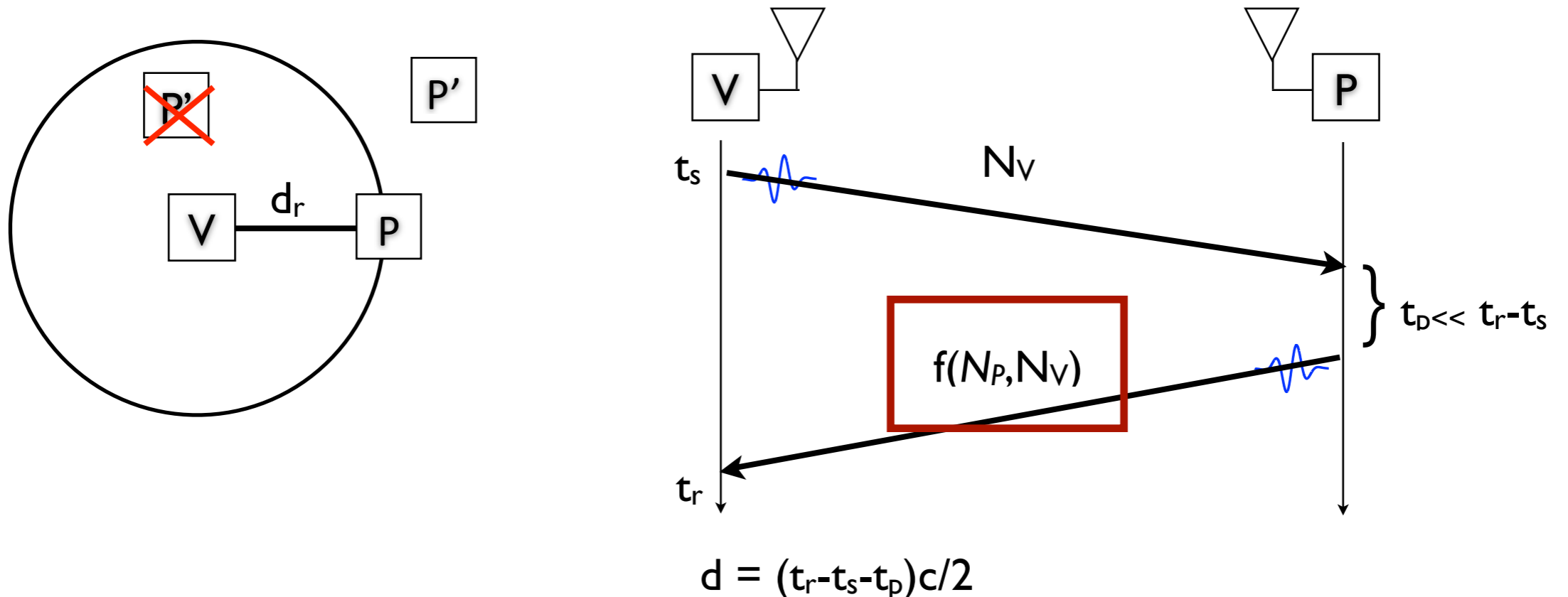

Property:

Measured distance d should be an *upper bound* on the true distance d_r between V and P.

Distance Bounding [BrandsChaum93]

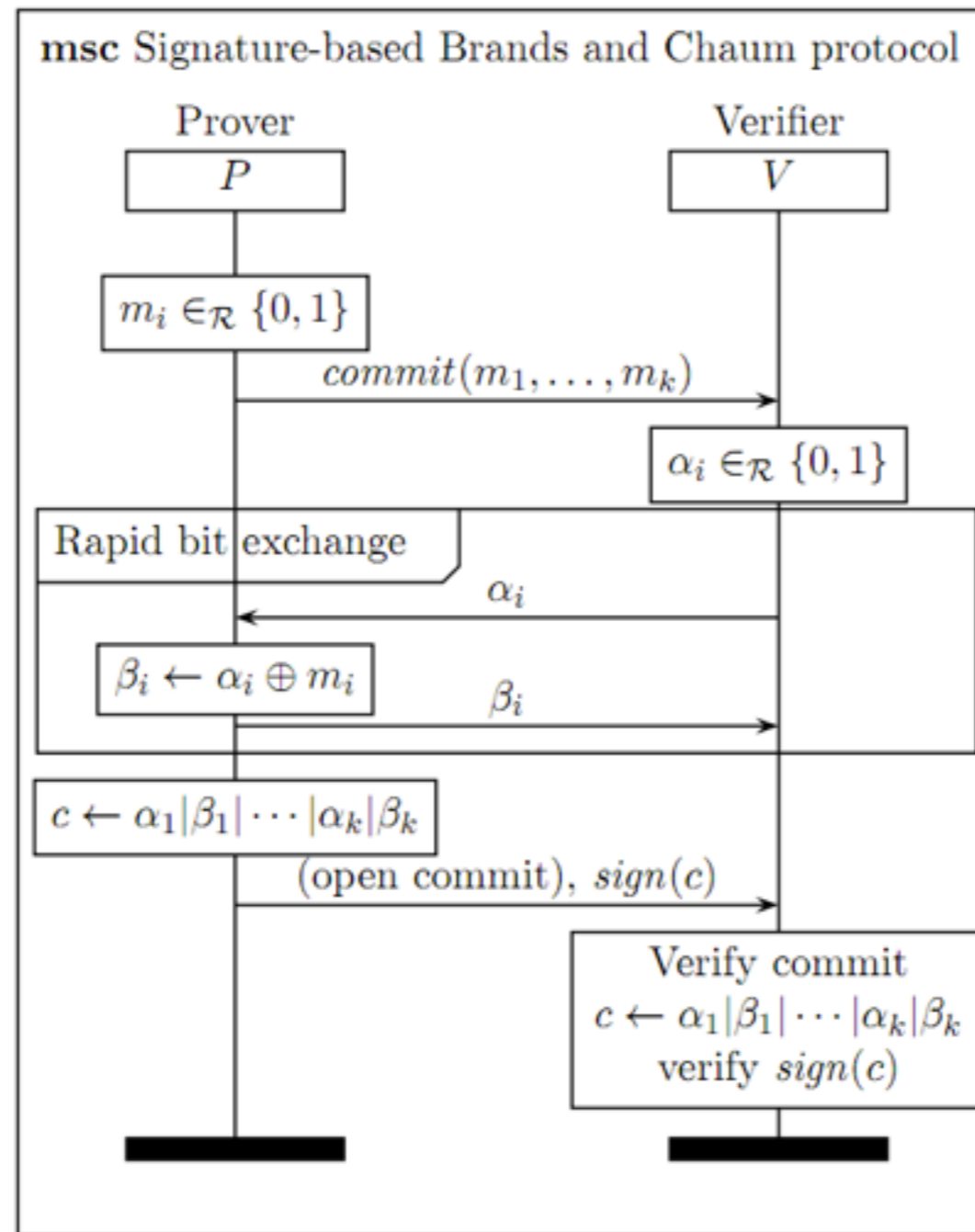

Distance Bounding: $f()$ and t_p

Provers should **quickly receive N_V , compute $f(N_V, N_P)$ and send $f(N_V, N_P)$**

- The verifier estimates prover's processing = t_p
- If attacker's processing = 0 then he **can cheat by $t_p/2$**
- Thus ideally $t_p=0s$, in most applications $t_p=1-2ns$ (15-30cm)
- t_p needs to be **stable and short**

Main assumption: we do not control the prover

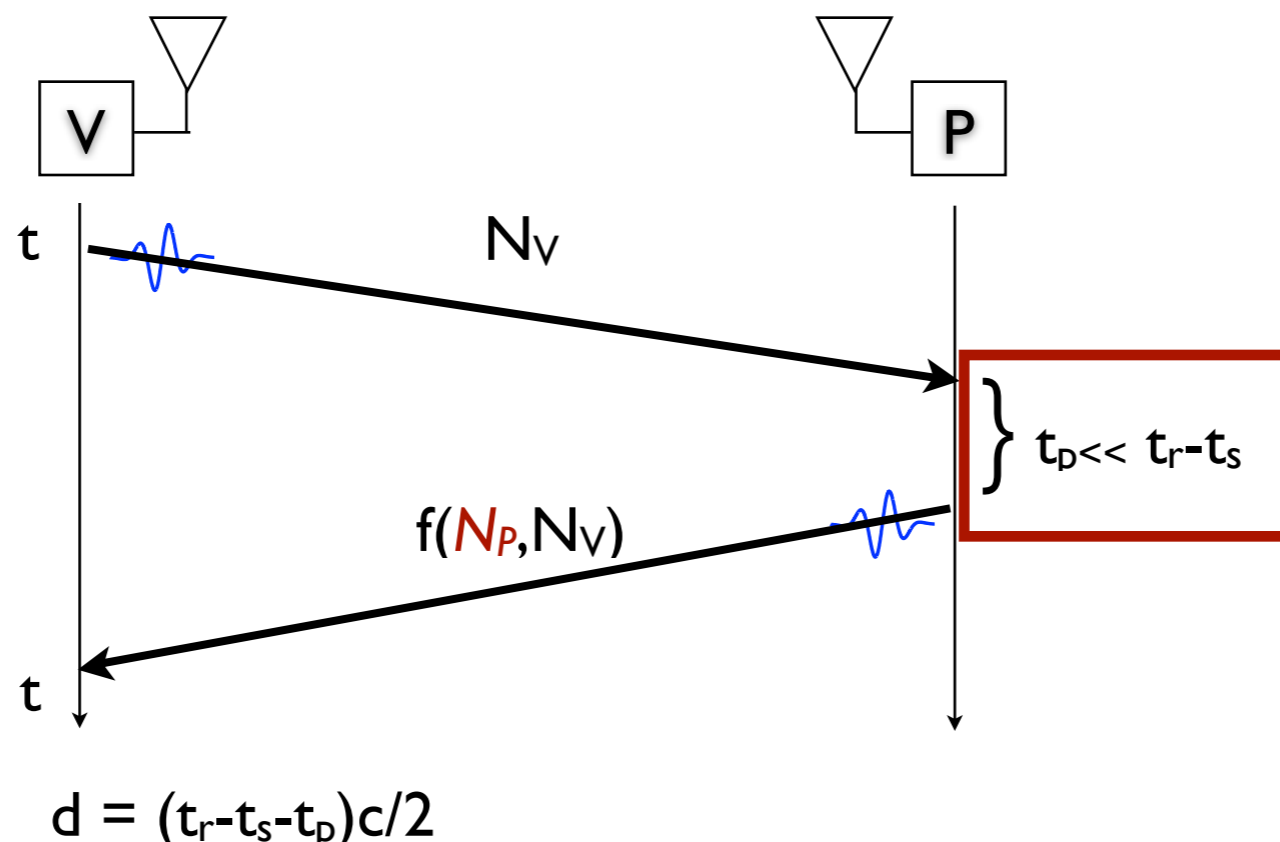

Distance Bounding: N_V

N_V and $f(N_P, N_V)$ should be “short” in the # of bits [HankeKuhn]

- short compared to the required accuracy / security

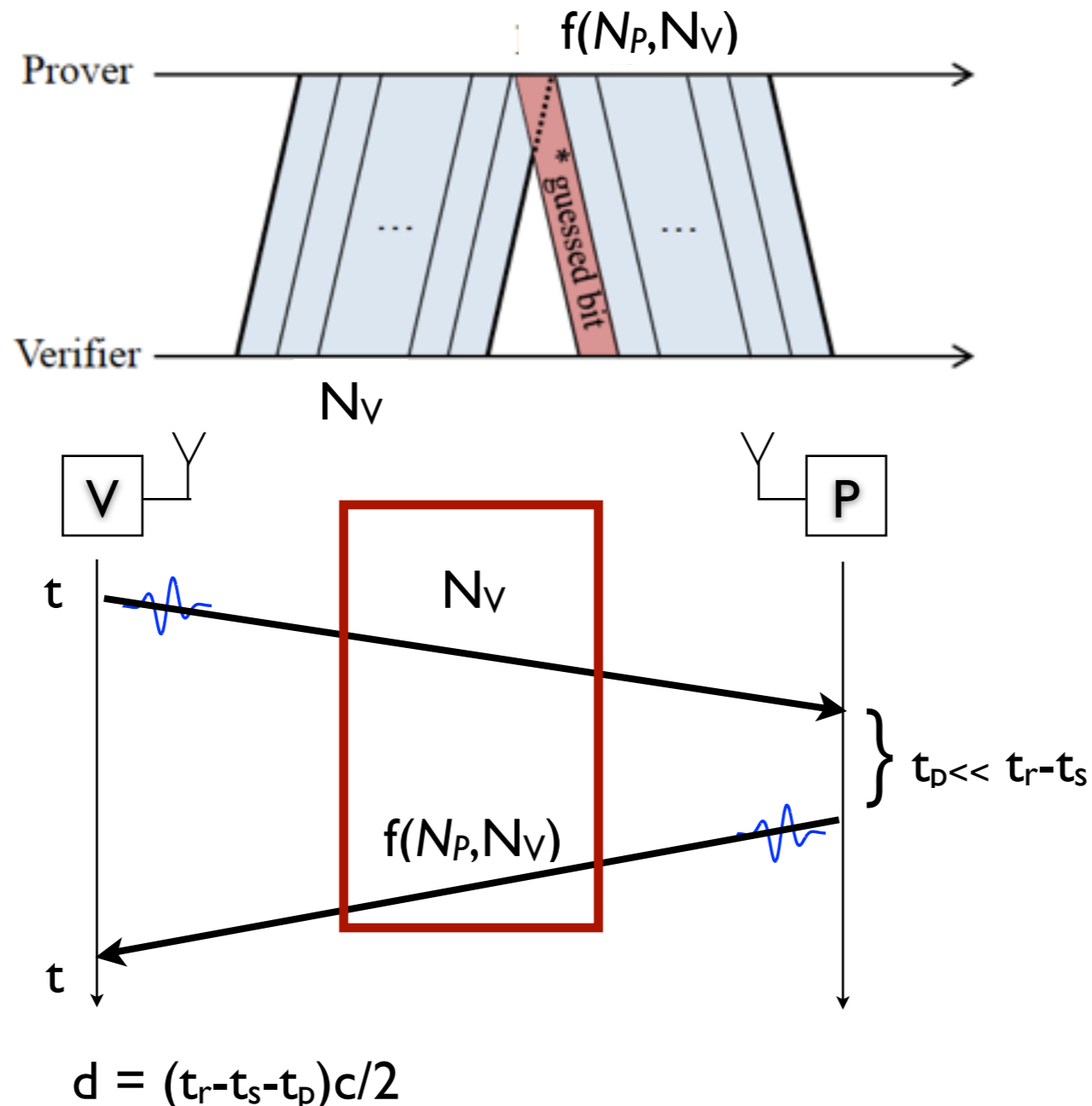

Distance Bounding: *symbols*

Assuming $|N_V|=1\text{bit}$, the symbols should be short as well

- short compared to the required accuracy / security
- Early Detection
- Late Commit
- Note: *channel spread does not help*

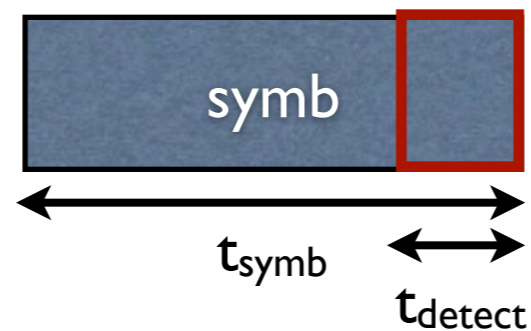

Distance Bounding: *symbols*

Assuming $|N_V|=1\text{bit}$, the symbols should be short as well

- short compared to the required accuracy / security
- Early Detection
- Late Commit
- Note: *channel spread does not help*

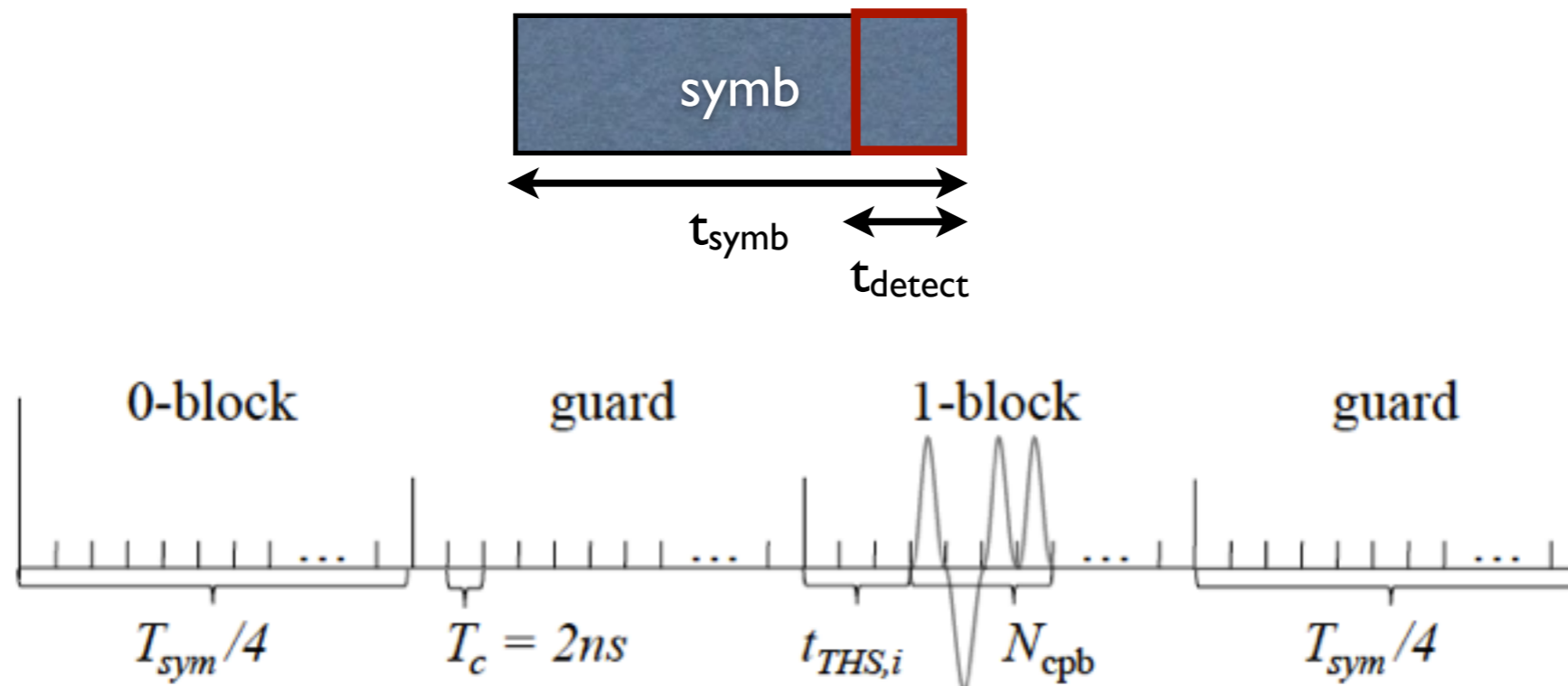

Figure 4.2: IEEE 802.15.4a data symbol structure [Poturalski2011]

Distance Bounding

experiments on 802.15.4a (IR UWB)

[Poturalski2011]

		No guessing		Max. guessing gain	
		(relay) time-gain	distance-decrease	(relay) time-gain	distance-decrease
En.D. against En.D.					
<i>Malicious Prover</i>	ED-only	$T_{\text{sym}}/4 + (t_{\text{det}} - t_{\text{det}}^{\text{A}})/2$	86m	$+ t_{\text{THS}}^{\text{max}}$	+ 74m
	LC-only	$T_{\text{sym}}/4 + t_{\text{PLC}}/2$	86m	$+ t_{\text{THS}}^{\text{max}}$	+ 74m
	ED+LC	$T_{\text{sym}}/2 + (t_{\text{PLC}} + t_{\text{det}} - t_{\text{det}}^{\text{A}})/2$	171m	$+ t_{\text{THS}}^{\text{max}}$	+ 74m
<i>Relay Attack</i>	ED+LC	$T_{\text{sym}}/2 + t_{\text{PLC}} - t_{\text{det}}^{\text{A}}$	171m	+ 0	+ 0m
Rake against En.D.					
<i>Malicious Prover</i>	ED-only	$T_{\text{sym}}/2 + (t_{\text{det}} - t_{\text{det}}^{\text{A}})/2$	162m	$+ T_{\text{sym}}/4 + t_{\text{THS}}^{\text{max}}$	+ 151m
	ED+LC	$3/4 \cdot T_{\text{sym}} + (t_{\text{PLC}} + t_{\text{det}} - t_{\text{det}}^{\text{A}})/2$	248m	$+ T_{\text{sym}}/4 + t_{\text{THS}}^{\text{max}}$	+ 151m
<i>Relay Attack</i>	ED+LC	$T_{\text{sym}} - t_{\text{THS}}^{\text{max}} + t_{\text{PLC}} - t_{\text{det}}^{\text{A}}$	251m	$+ T_{\text{sym}}/2 + 2 \cdot t_{\text{THS}}^{\text{max}}$	+ 302m
	ED-only	$T_{\text{sym}}/2 - t_{\text{THS}}^{\text{max}} - t_{\text{det}}^{\text{A}}$	79m	$+ T_{\text{sym}}/2 + 2 \cdot t_{\text{THS}}^{\text{max}}$	+ 302m
Rake against Rake					
<i>Malicious Prover</i>	ED-only	$(t_{\text{det}} - t_{\text{det}}^{\text{A}})/2$	5m	$+ T_{\text{sym}}/4 + t_{\text{THS}}^{\text{max}}$	+ 151m
	LC-only	$t_{\text{PLC}}/2$	5m	$+ T_{\text{sym}}/4 + t_{\text{THS}}^{\text{max}}$	+ 151m
	ED+LC	$(t_{\text{det}} + t_{\text{PLC}} - t_{\text{det}}^{\text{A}})/2$	10m	$+ T_{\text{sym}}/2 + t_{\text{THS}}^{\text{max}}$	+ 228m
<i>Relay Attack</i>	ED+LC	$t_{\text{PLC}} - t_{\text{det}}^{\text{A}}$	10m	+ 0	+ 0m

Table 4.2: Upper-bound on (relay) time-gain and (relay) distance-decrease of various PHY attacks in various “adversarial receiver against honest receiver” configurations. The left column presents conservative attacks, that work with 100% success probability. The right column presents the maximal additional time-gain/distance-decrease that can be achieved by combining PHY attacks and guessing attacks (when time guessing probability approaches the guessing probability of pure guessing attacks). Time-gain is expressed in terms of T_{sym} – data symbol duration, $t_{\text{det}} = 48\text{-}60\text{ns}$ – detection time of honest receivers without ED-countermeasure, $t_{\text{det}}^{\text{A}}$ – detection time of the adversary, $t_{\text{PLC}} < t_{\text{det}}$ – pulse LC delay, $t_{\text{THS}}^{\text{max}}$ – maximum time-hopping offset. The distance-decrease is shown for the IEEE 802.15.4a mandatory modes and delay values that maximize the distance-decrease.

Distance Bounding: *symbols*

*Chirp SS ranging (802.15.4) systems strongly affected**

- long symbol lengths allow for simple ED and LC attacks
- Early Detection
- Late Commit

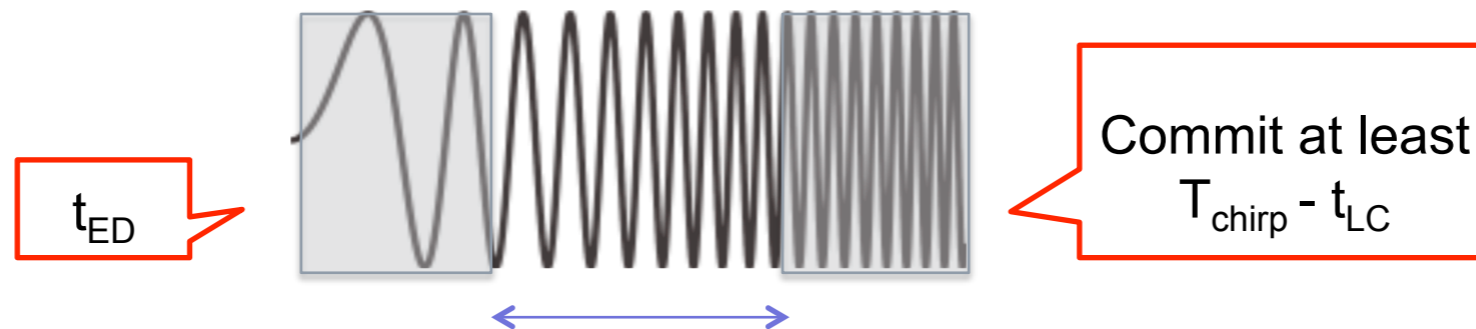

$$t_{\text{GAIN}} = t_{\text{LC}} - t_{\text{ED}} - t_{\text{HW}}$$

$$D = c \times t_{\text{GAIN}}$$

*[RanganathanWisec12]

Realization of RF Distance Bounding: *Processing Function $f(N_v, N_p)$*

$f(N_v, N_p)$ is computed by the prover:

- takes as input N_v (received from the verifier)
- takes as input N_p (locally generated by the prover)
- Should allow that the prover: *receives N_v , computes and outputs $f(N_v, N_p)$ in a short time (few ns)*

DB protocols in the literature:

[BethDesmedt] $\text{sign}(N_v); h(N_v); \text{mac}(N_v); E(N_v); \dots \Rightarrow t_p \gg \text{ns}$

[BrandsChaum, CapkunInfocom05, ...] *XOR* $\Rightarrow t_p = ?$

[HanckeKuhn, TippenhauerESORICS09, ...] *bit comparison* $\Rightarrow t_p = ?$

> 20 proposed protocols, not one was **fully** implemented

Can the proposed DB protocols be realized?

Realization of RF Distance Bounding: Processing Function $f(N_v, N_p)$

[BethDesmedt] $\text{sign}()$; $h()$; $\text{mac}()$; $E()$; ... $\Rightarrow t_p \gg \text{ns}$

[BrandsChaum, ...] **XOR** $\Rightarrow t_p = ?$ ($n \times 100\text{ns}$?)

[HanckeKuhn, ...] **bit comparison** $\Rightarrow t_p = ?$ ($n \times 100\text{ns}$?)

[RasmussenSec09, ...] **CRCS (analog modulation)** $\Rightarrow t_p < 1\text{ns}$

... > 20 proposed protocols

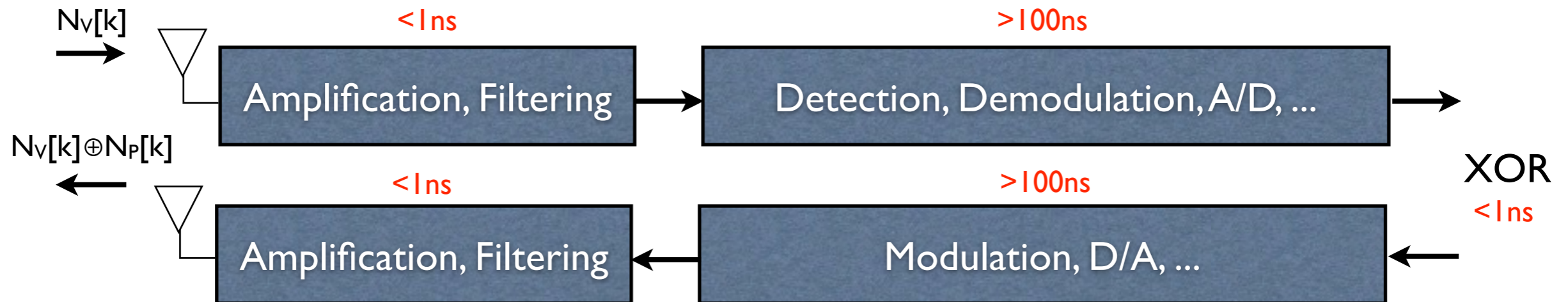

Can we use functions that require interpretation (demodulation) N_v ?

Realization of RF Distance Bounding: Processing Function $f(N_v, N_p)$

[BethDesmedt] $\text{sign}()$; $h()$; $\text{mac}()$; $E()$; ... $\Rightarrow t_p \gg \text{ns}$

[BrandsChaum, ...] *XOR* $\Rightarrow t_p = ?$ ($n \times 100\text{ns}$?)

[HanckeKuhn, ...] *bit comparison* $\Rightarrow t_p = ?$ ($n \times 100\text{ns}$?)

[RasmussenSec09, ...] *CRCS (analog modulation)* $\Rightarrow t_p < 1\text{ns}$

... > 20 proposed protocols

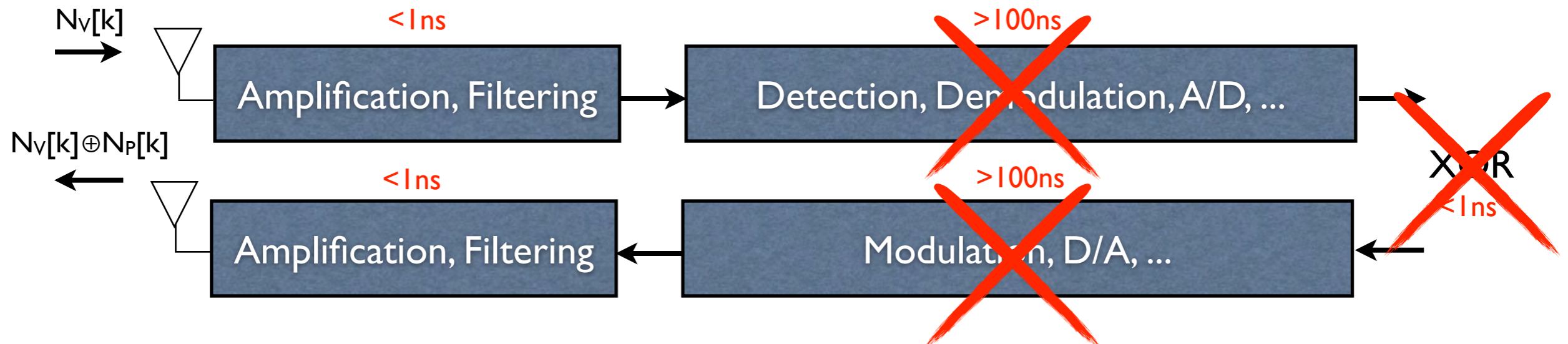

Can we use functions that require interpretation (demodulation) N_v ?

A new Function: CRCs

Our approach: *Challenge Reflection with Channel Selection*

- Prover does not interpret N_v
- All *time-critical* processing is done in *analog*
- Verifier does “all the work”

Main idea (C_0, C_1, C_2 are channels)

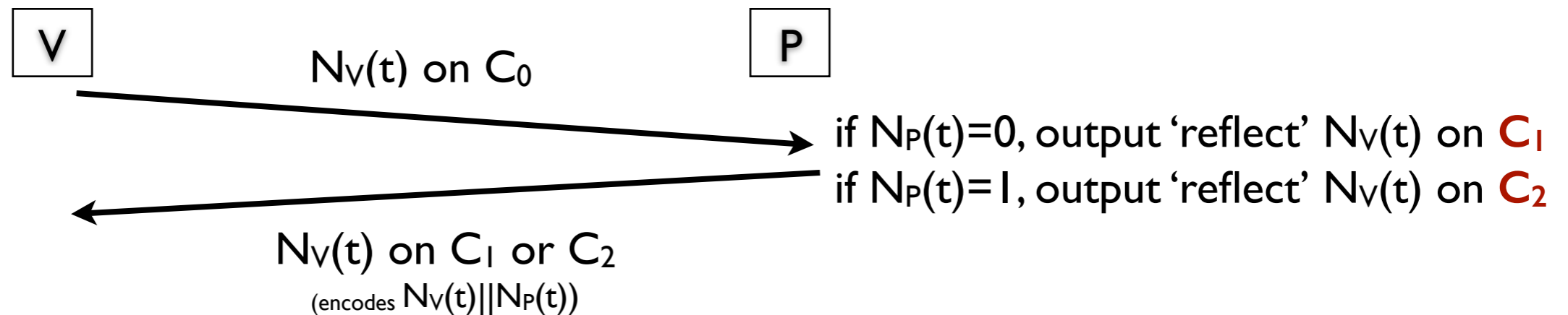

A new Function: CRCS

Our approach: *Challenge Reflection with Channel Selection*

- Prover does not interpret Nv
- All *time-critical* processing is done in *analog*
- Verifier does “all the work”

Main idea (C_0, C_1, C_2 are channels)

A new Function: CRCs

Our approach: *Challenge Reflection with Channel Selection*

- Prover does not interpret N_v
- All *time-critical* processing is done in *analog*
- Verifier does “all the work”

Main idea (C_0, C_1, C_2 are channels)

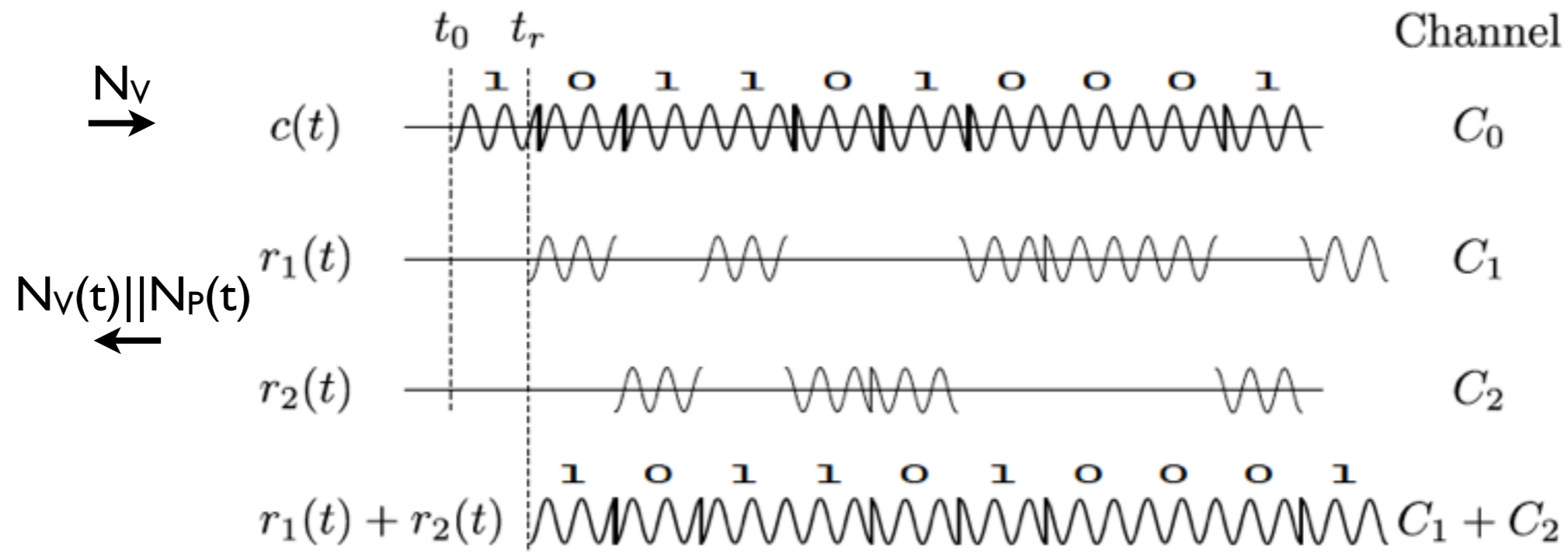

A new Function: CRCs

Implementation of CRCs

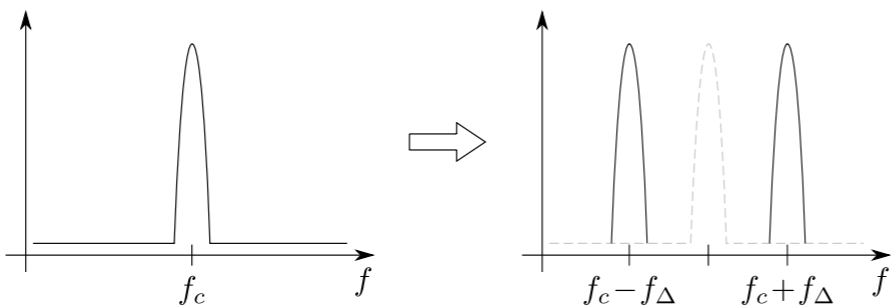
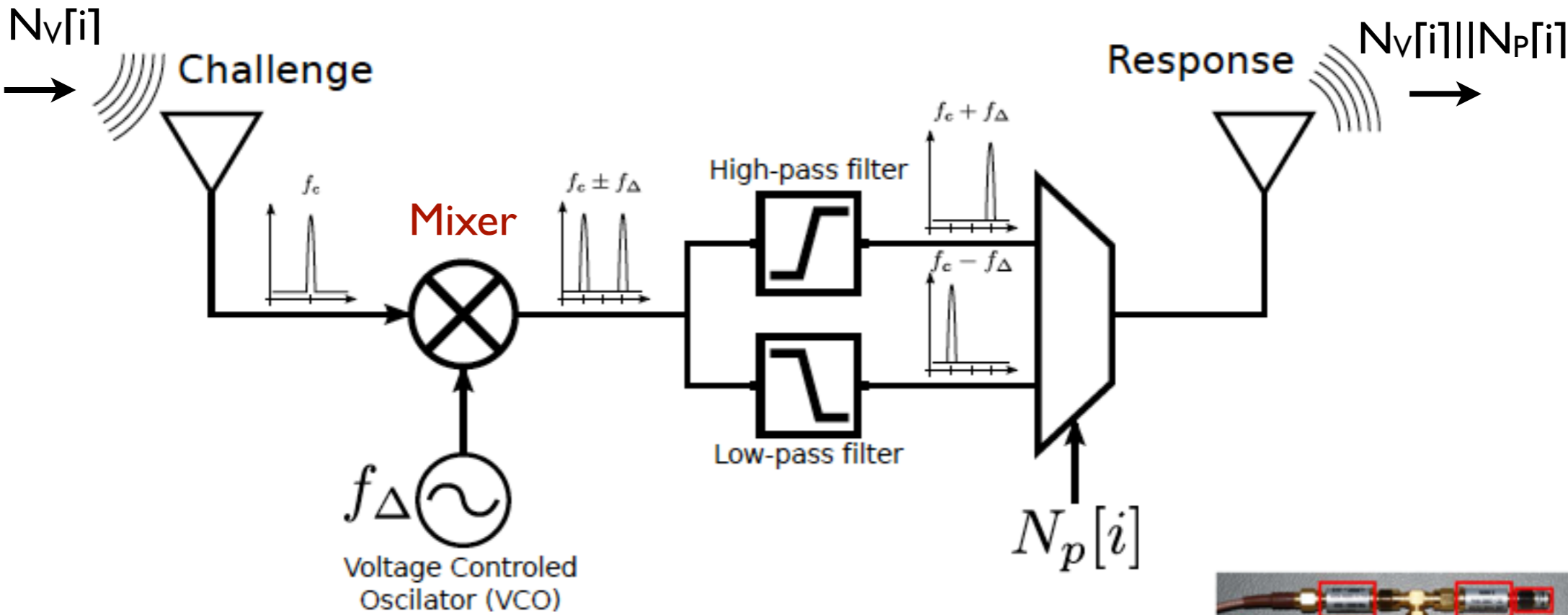

Mixer up+down converts the input signal

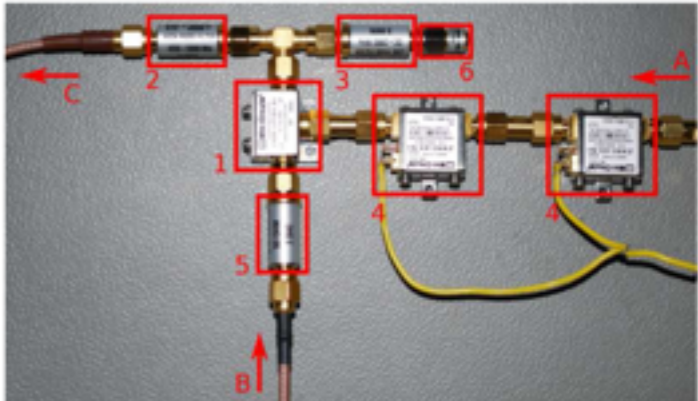

A new Function: CRCs

Implementation of CRCs

$t_p < 1\text{ns}$, st. dev. 61ps, full duplex

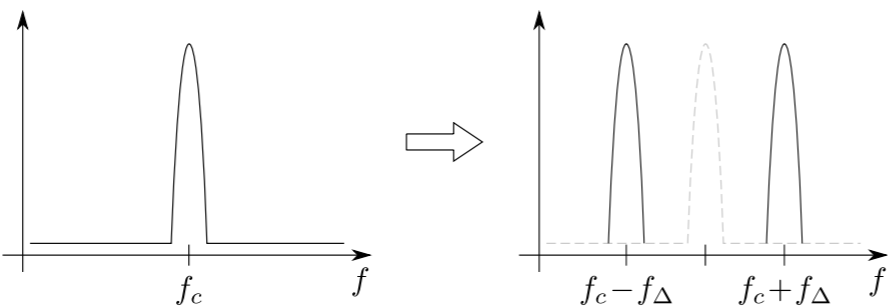
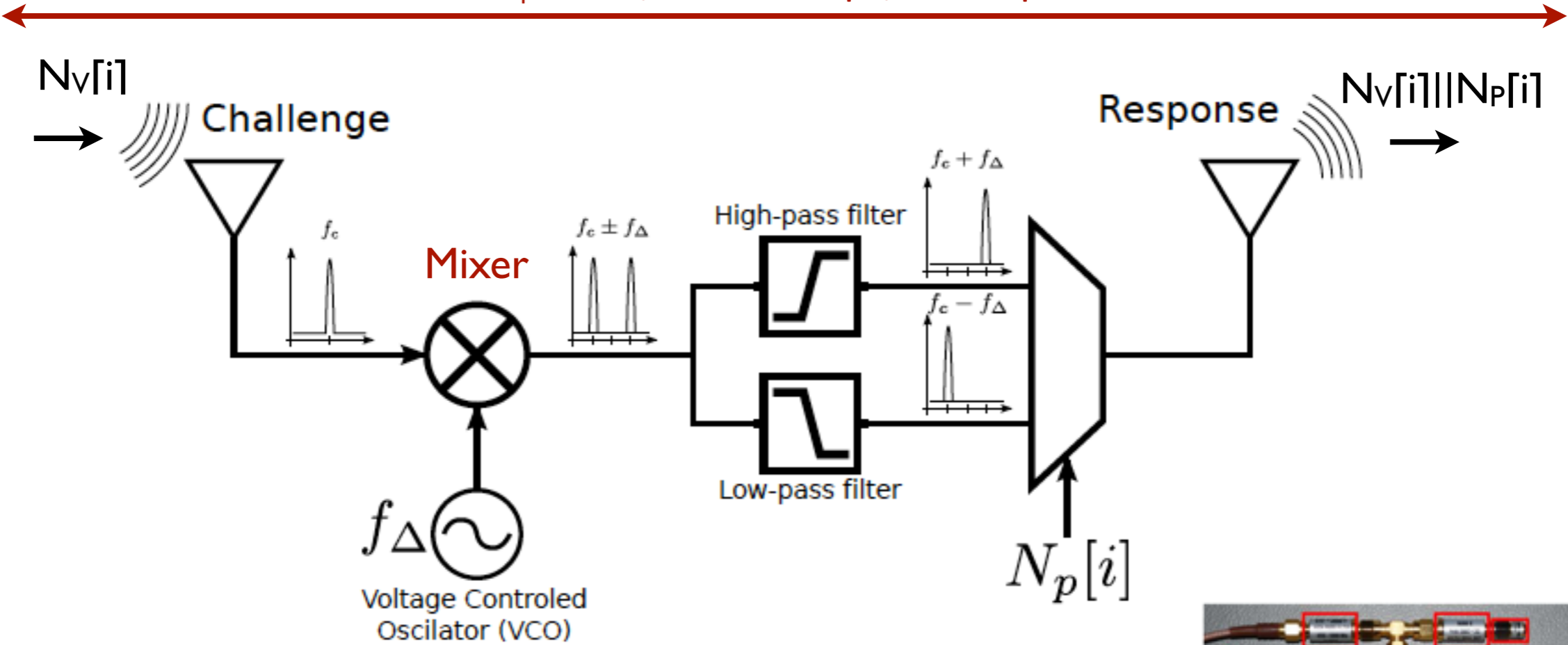

Mixer up+down converts the input signal

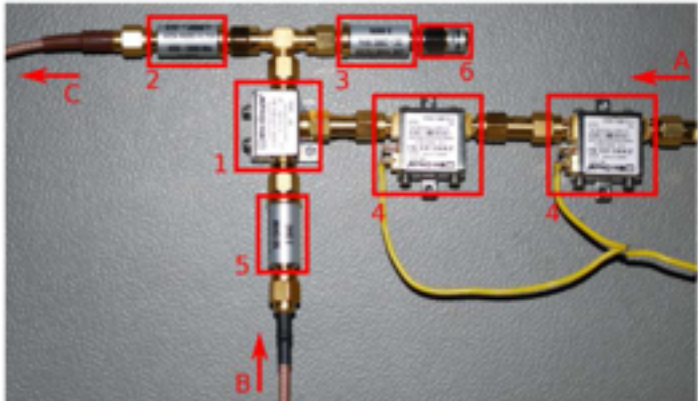

A new Function: CRCs

CRCs++ (measured at the input/output of the prover)

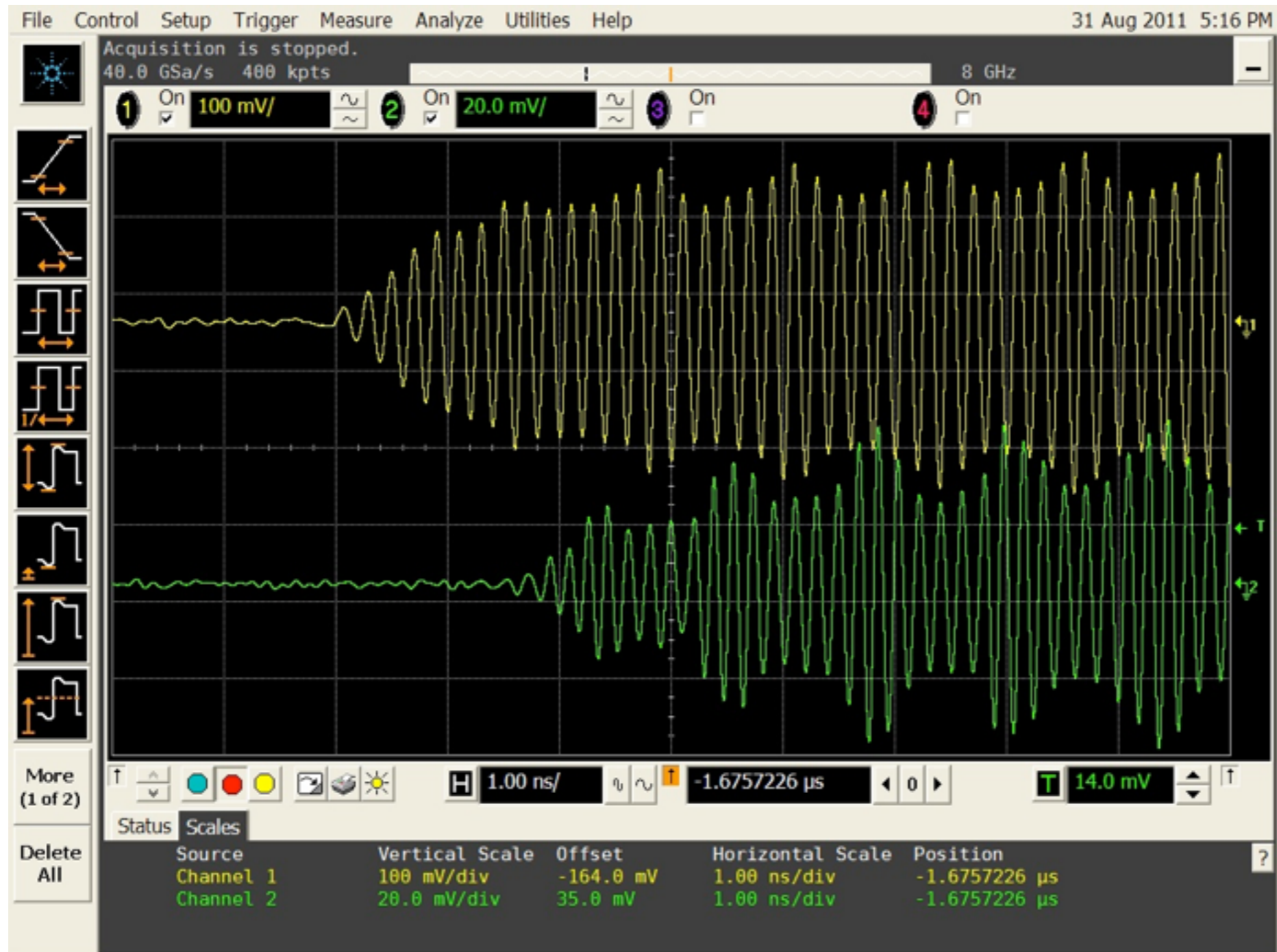

Two basic Attacks on DB protocols

Distance Fraud

- dishonest prover pretends to be closer to the verifier
- “pacemaker scenario”

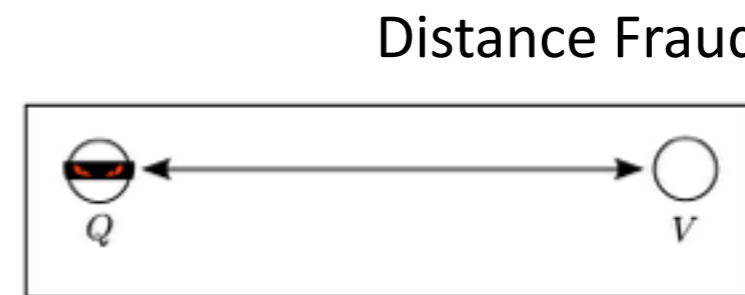

Mafia Fraud

- honest prover
- attacker convinces verifier and prover that they are closer
- relay attack (“car and key scenario”)

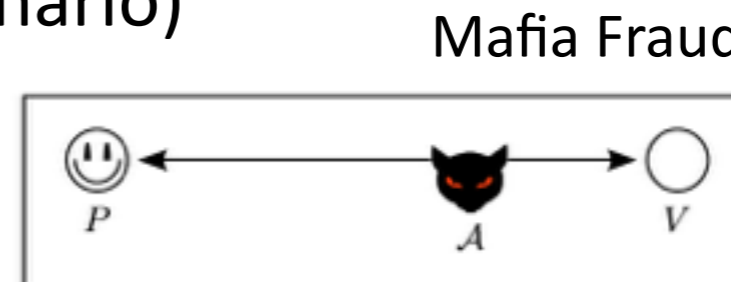

A new Function: CRCS

CRCS-based DB protocol (*vs Distance and Mafia Fraud*)

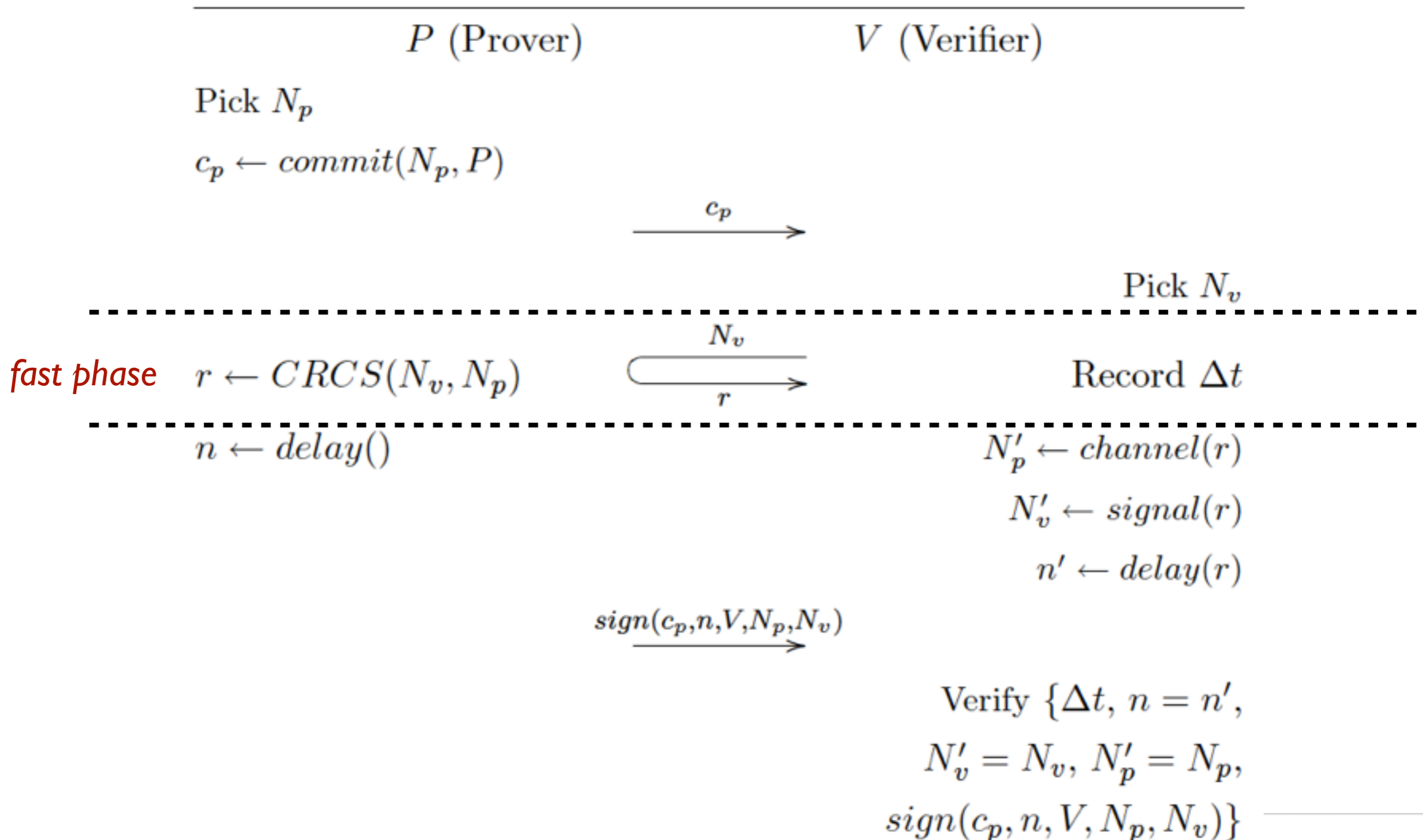

A new Function: CRCs

CRCs-based DB protocol (*vs Distance and Mafia Fraud*)

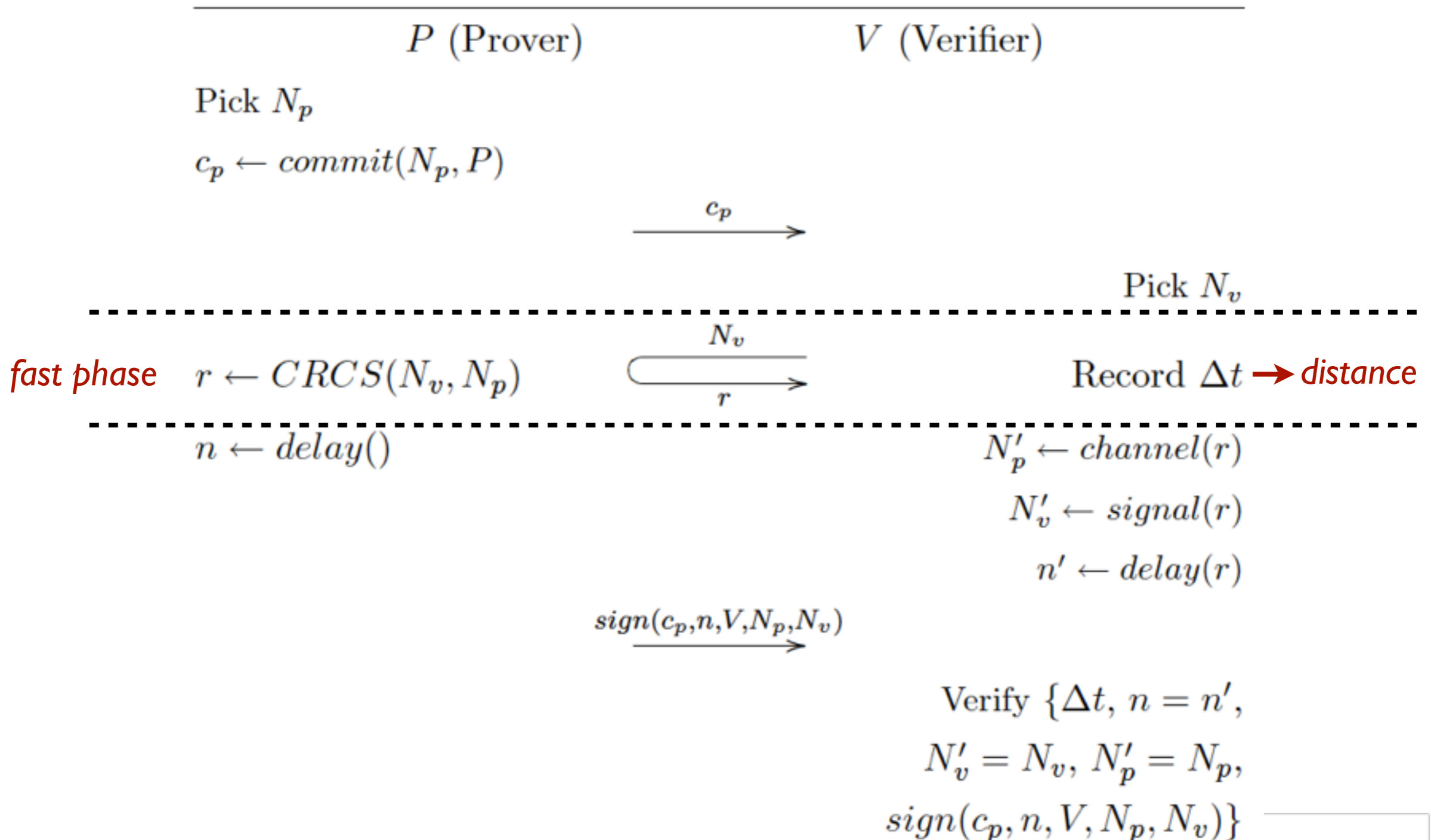

A new Function: CRCs

CRCs-based DB protocol (*vs Distance and Mafia Fraud*)

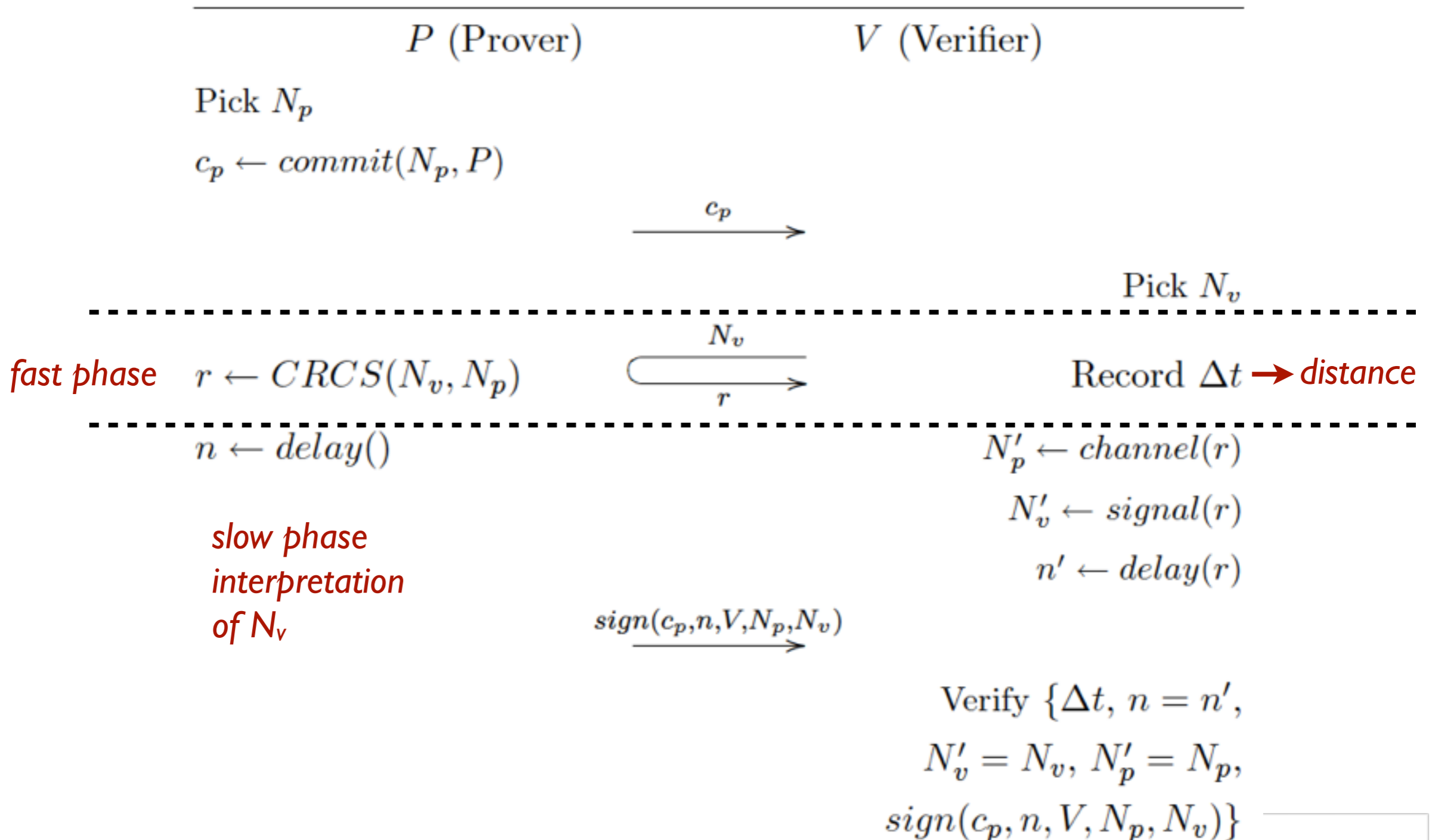

A new Function: CRCs

CRCs-based DB protocol (*vs Distance and Mafia Fraud*)

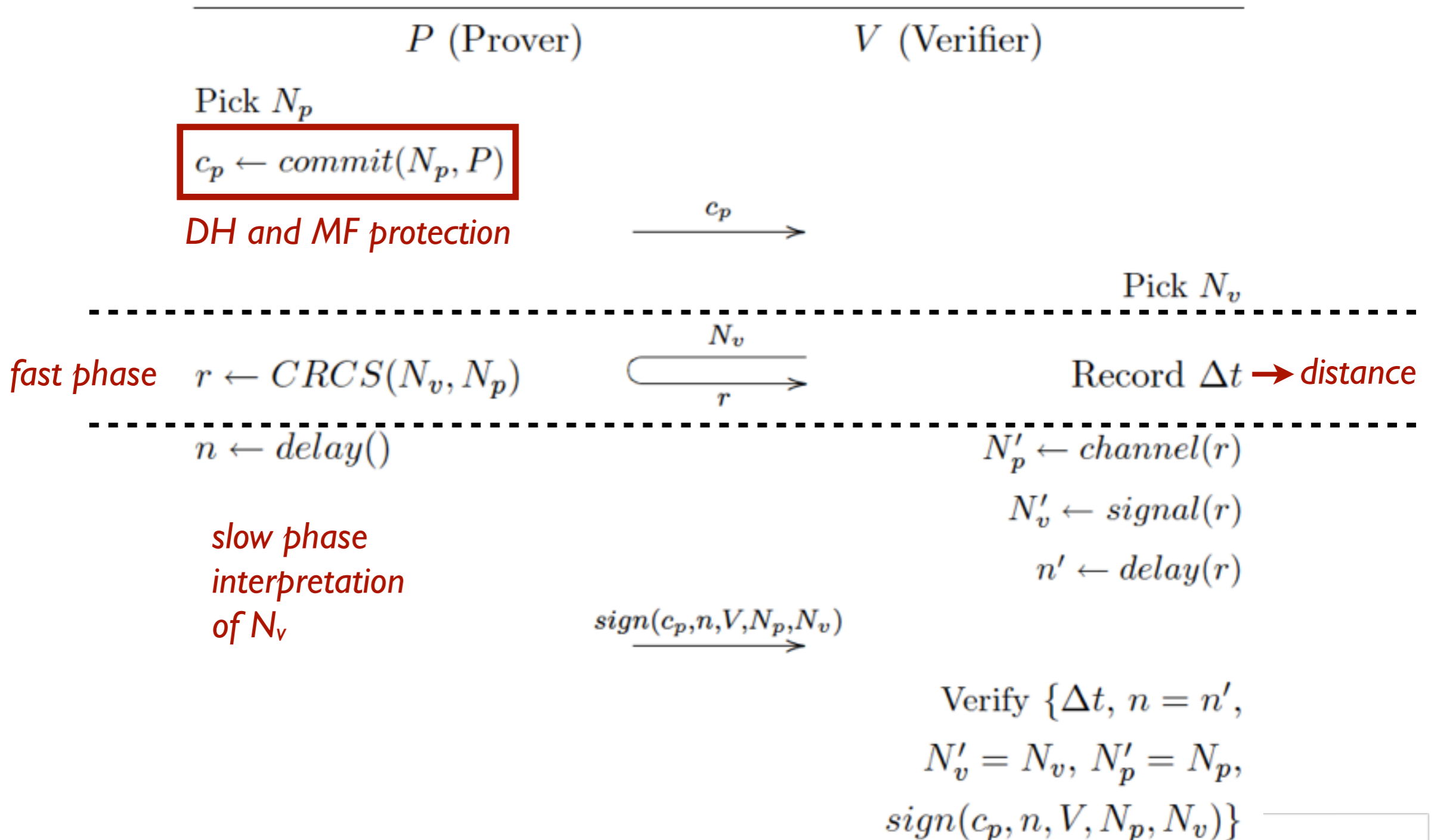

A new Function: CRCs

CRCs-based DB protocol (*vs Distance and Mafia Fraud*)

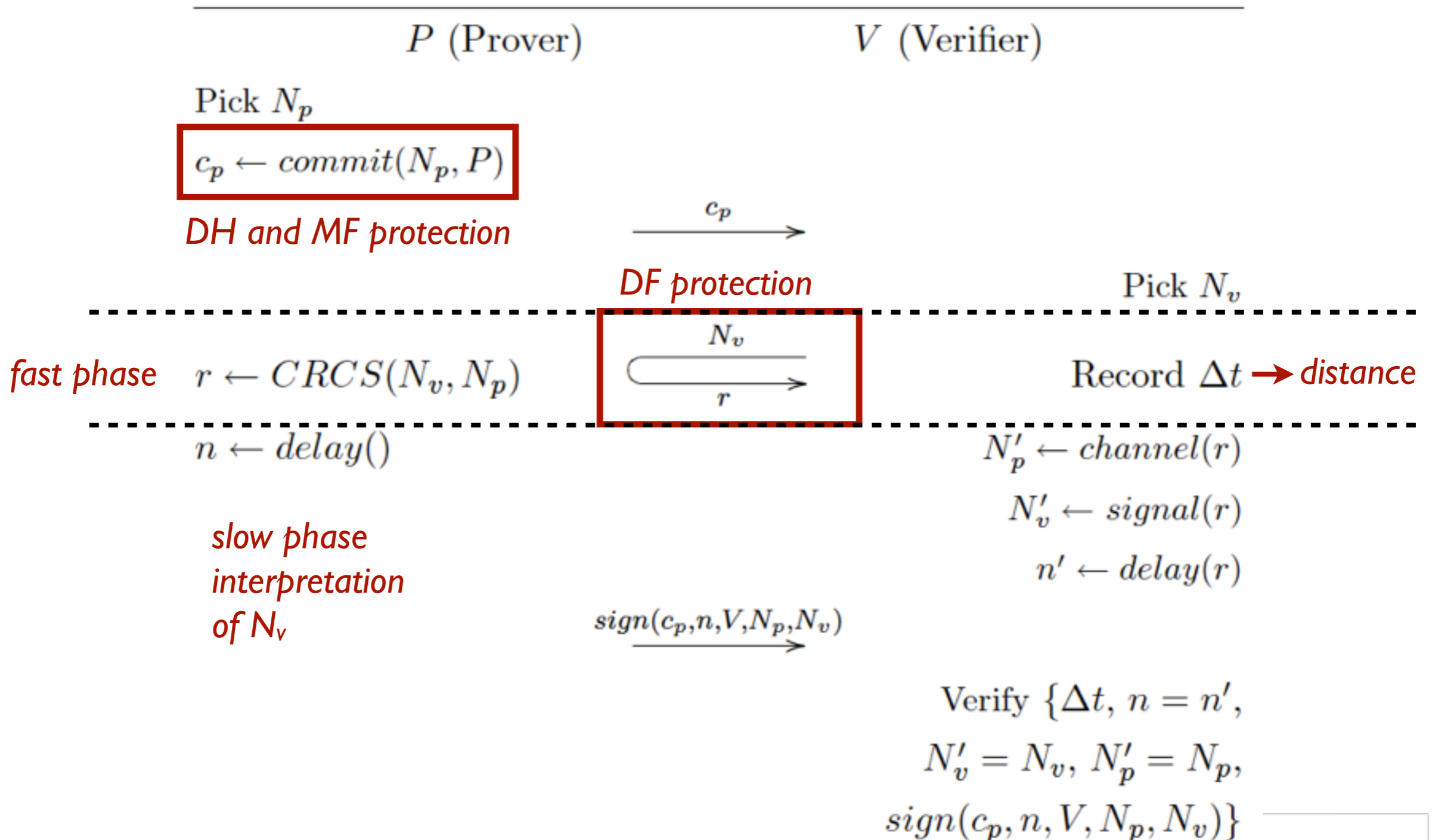

A new Function: CRCs

CRCs-based DB protocol (*vs Distance and Mafia Fraud*)

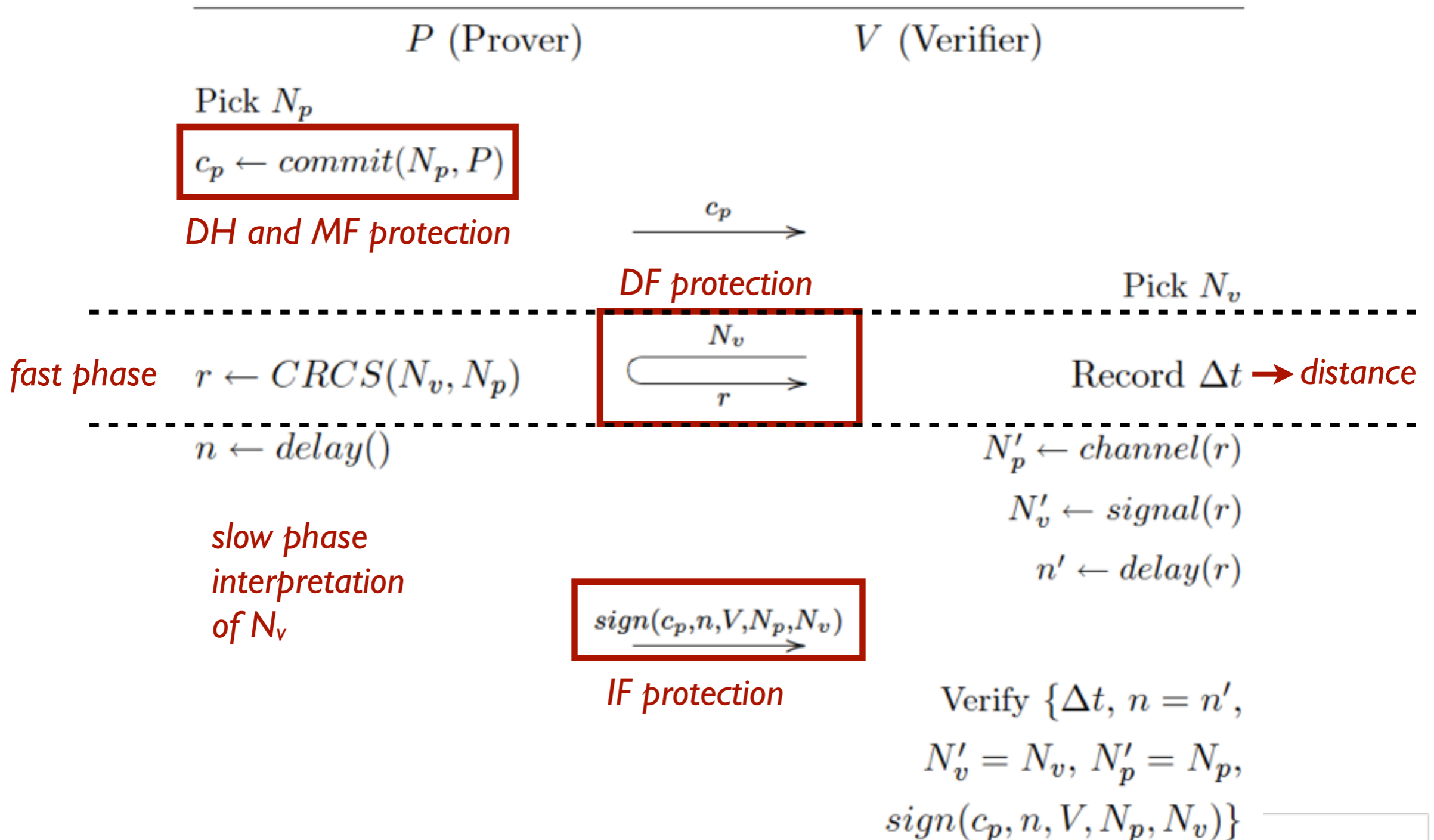

A new Function: CRCs

CRCs-based DB protocol (*vs Distance and Mafia Fraud*)

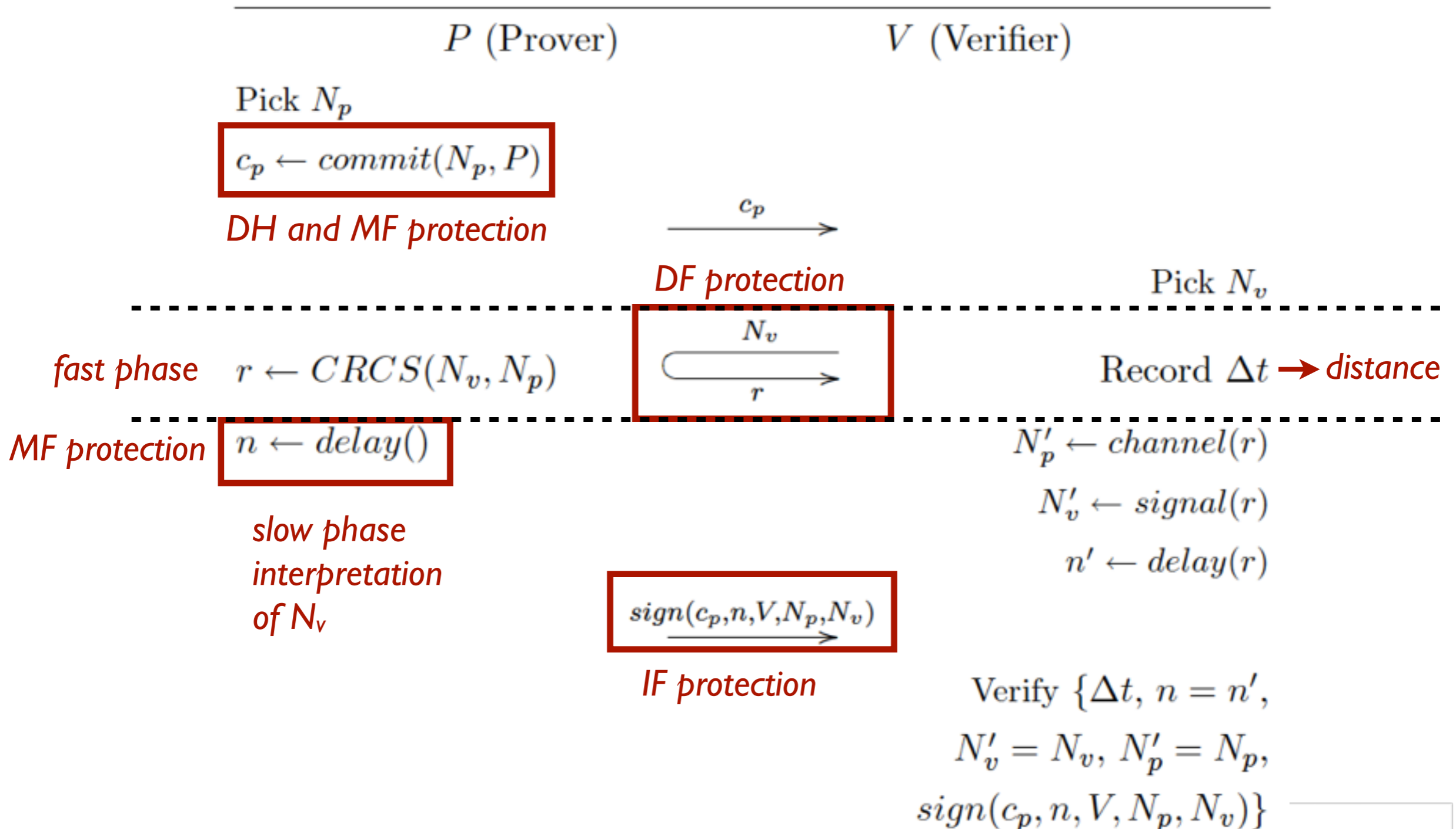

A new Function: CRCs

Mafia Fraud Detection (*physical layer*)

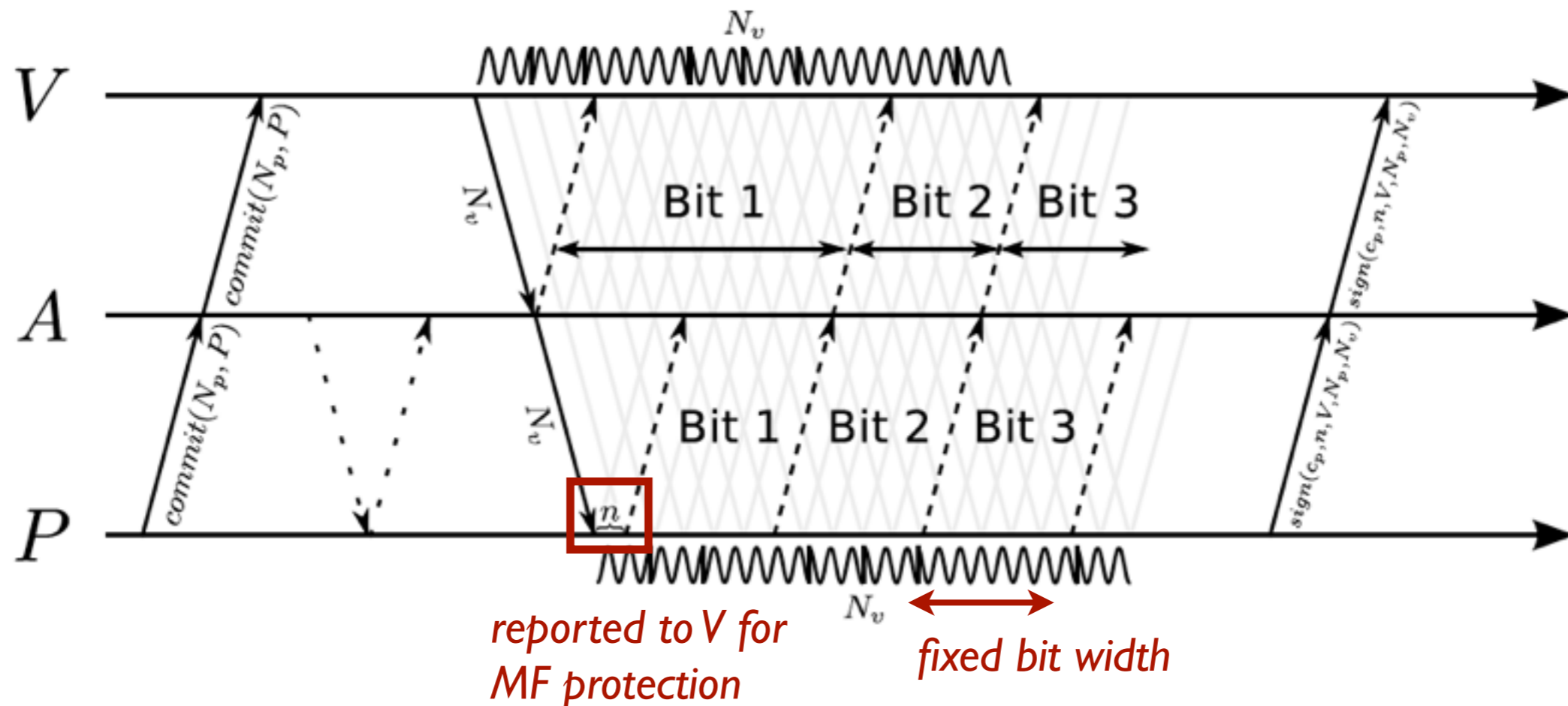

MF attack: $\frac{1}{2^{|N_p|}}$; DF attack: $\frac{1}{2^{|N_v|}}$

CRCs eliminates early detection, late commit attacks

Ongoing work on CRCS

Using CRCS the prover also reflects noise
=> CRCS increases complexity of the Verifier

In essence, CRCS trades

- robustness for increased security
- reduces complexity of the prover but increases the complexity of the verifier
- range might be affected by the use of CRCS (?)

What I didn't talk about (synchronization, preambles, ...).

Ongoing implementations ...

...

Other Implementation Efforts

Going back to XOR.

- What is the “fastest” implementation that we can make with $f(N_v, N_p) = N_v \oplus N_p$?
- What kind of a receiver are we considering?

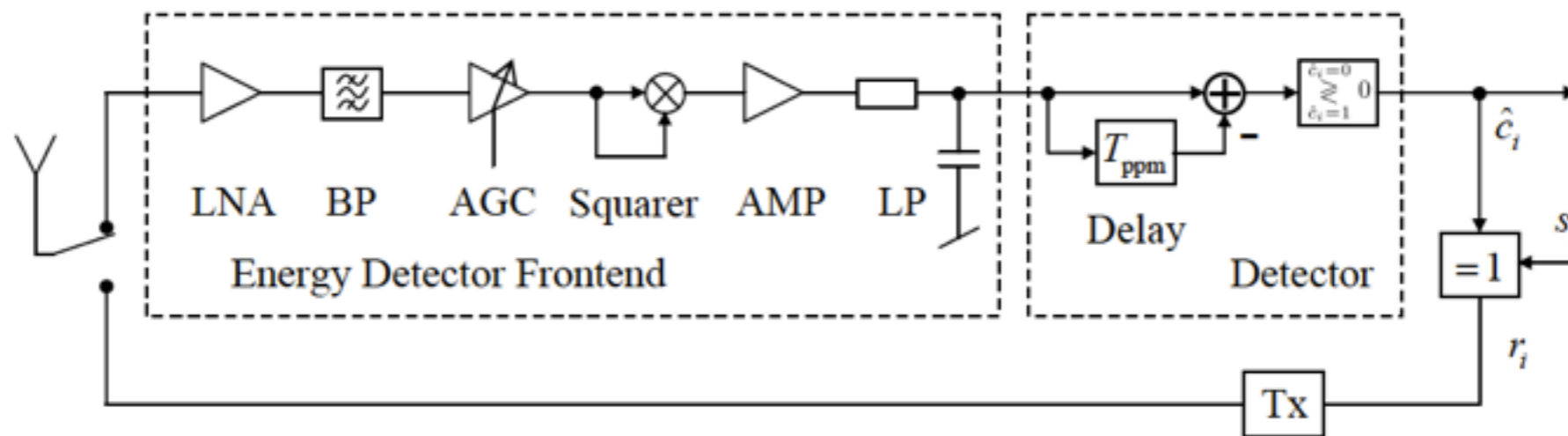

- A different modulation (SEM vs BPPM)

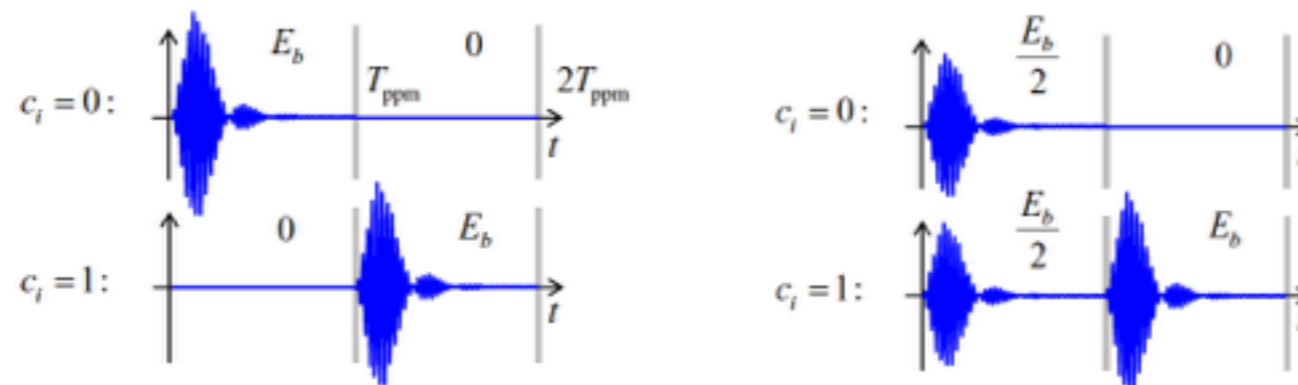

Protocol Analysis

Two main protocol constructs:

- Hancke-Kuhn
- Brands-Chaum

Three main attacks considered:

Distance Fraud



Terrorist Fraud



Mafia Fraud

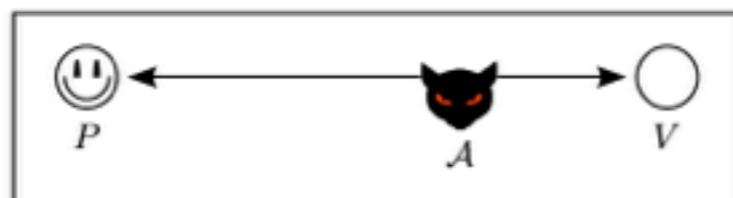

Protocol Analysis

Two main protocol constructs:

- Hancke-Kuhn
- Brands-Chaum

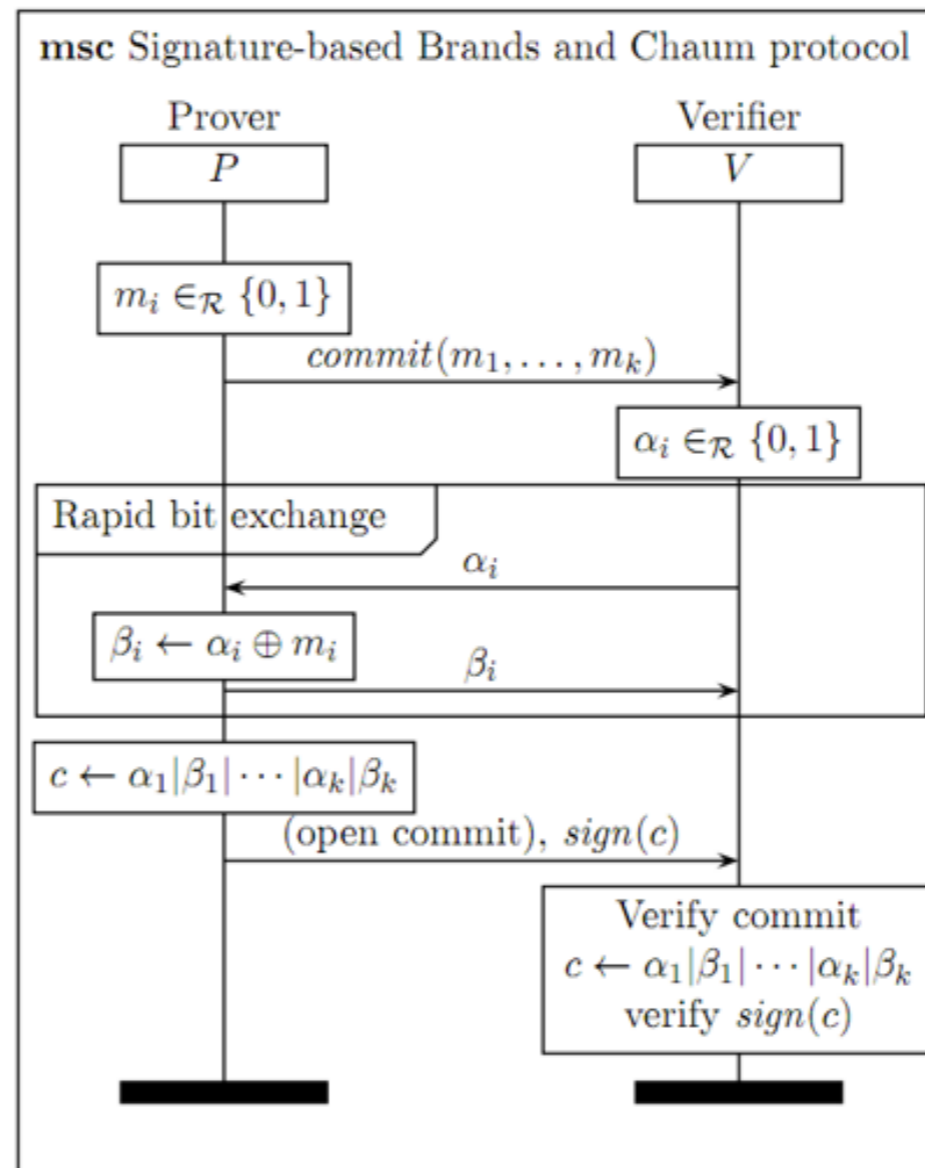

Protocol Analysis

Novel attack: Distance Hijacking

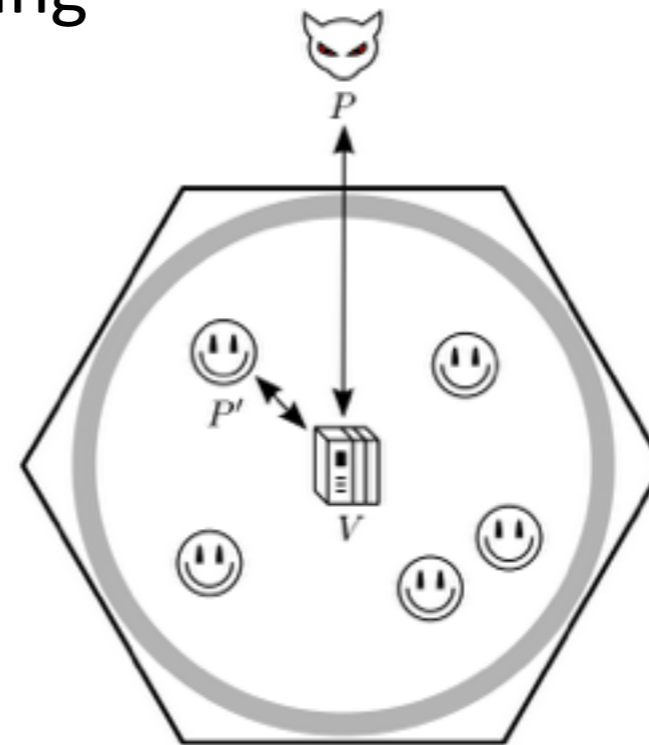

Distance Fraud

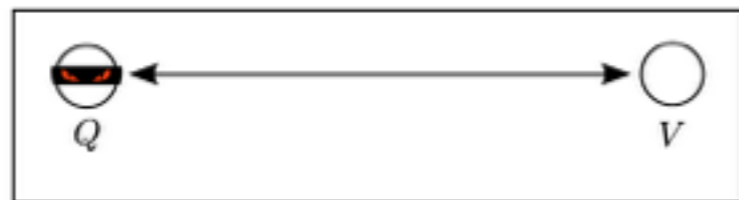

Terrorist Fraud



Mafia Fraud



Distance Hijacking

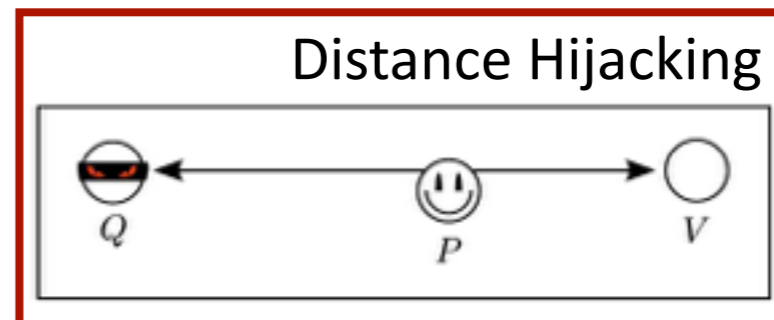

Protocol Analysis

Distance Hijacking on Brands and Chaum

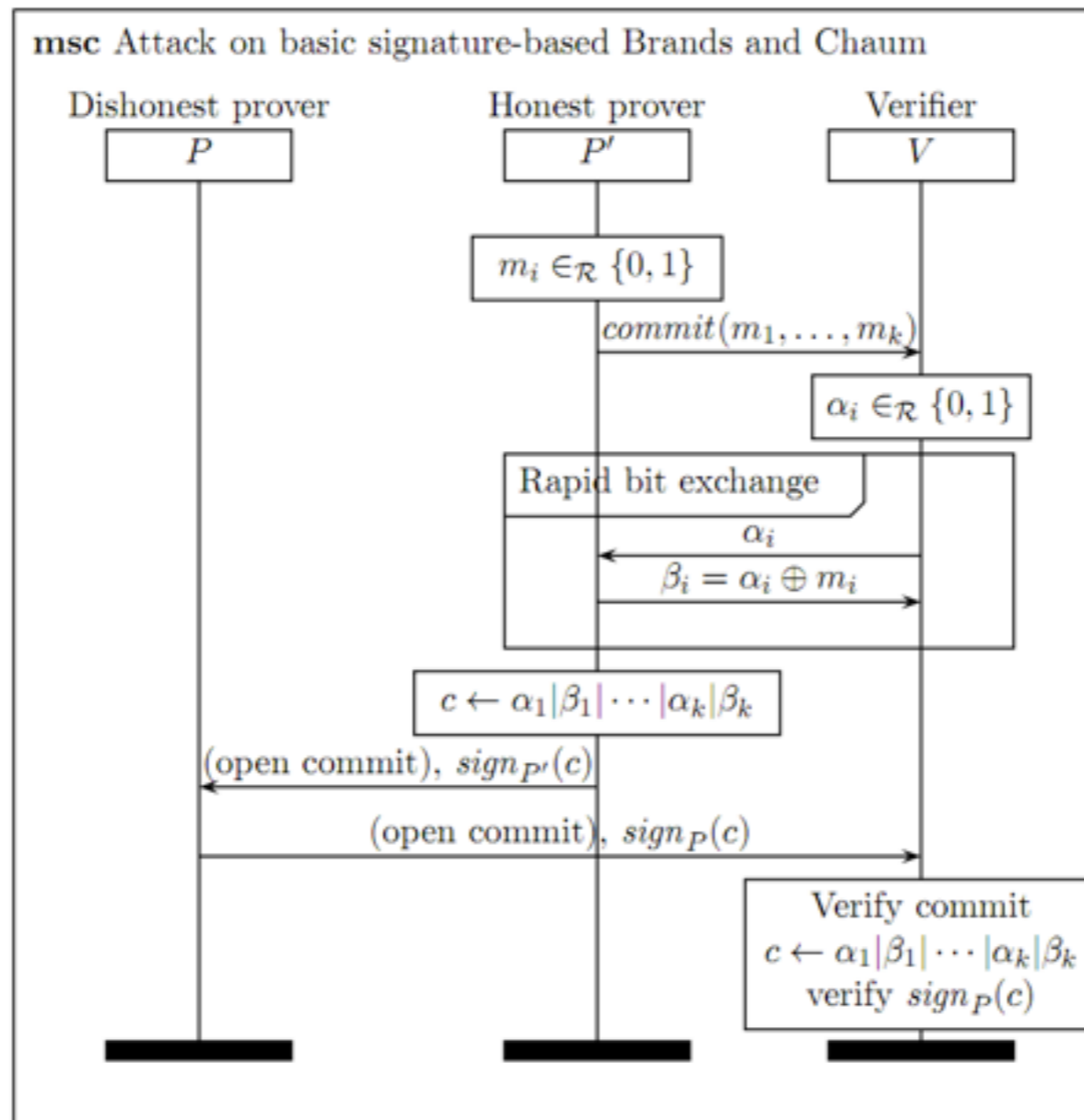

Protocol Analysis

More Distance Hijacking

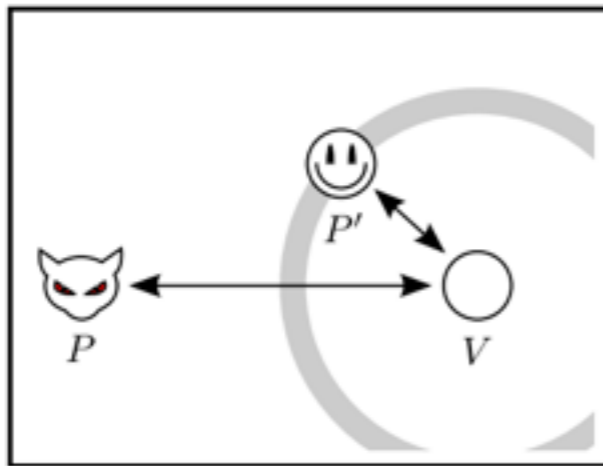

Figure 7: Scenario in which V accepts protocol sessions from multiple provers, here P and P' , where Distance Hijacking may be a threat.

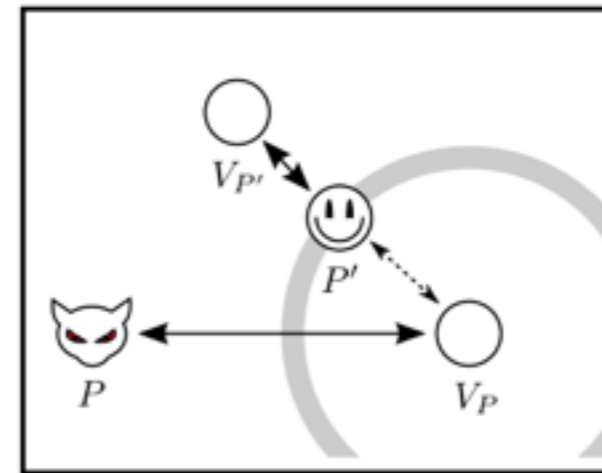
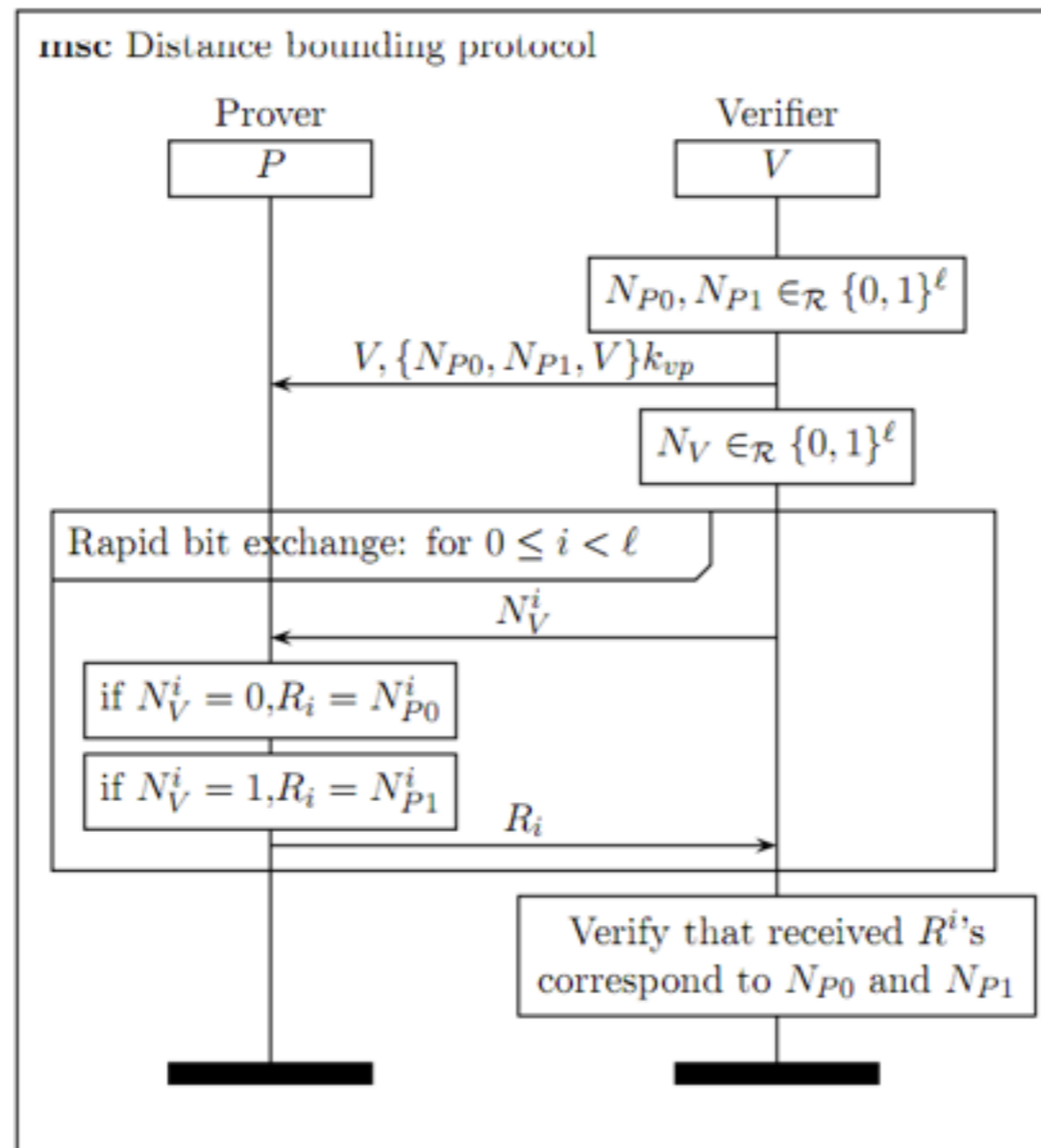

Figure 8: Scenario with multiple prover/verifier pairs, where V_x only accepts sessions from x . Even in this case, Distance Hijacking may be possible.

Protocol Analysis

Attack on Hancke-Kuhn (indirect)



DB Protocol Analysis (Formal)

Authentication and Key Establishment protocols

- analyzed in the Dolev-Yao model
- no notions of location, channel characteristics, (or time)
- the same frameworks cannot analyze DB protocol

Some new framework can capture physical properties (*time, location, physical layer*) e.g., [Basin10]

- Model based on experiments with real systems
- Enables formal analysis of DB protocols
- Captured new attacks on DB that we missed in the informal analysis

Other frameworks: Avoine, Meadows,

Game is not over ... (ref. Distance Hijacking attacks)

One Use of DB -> Authentication Based on *Absence* Awareness

How would Proximity-Based Access Control be implemented?

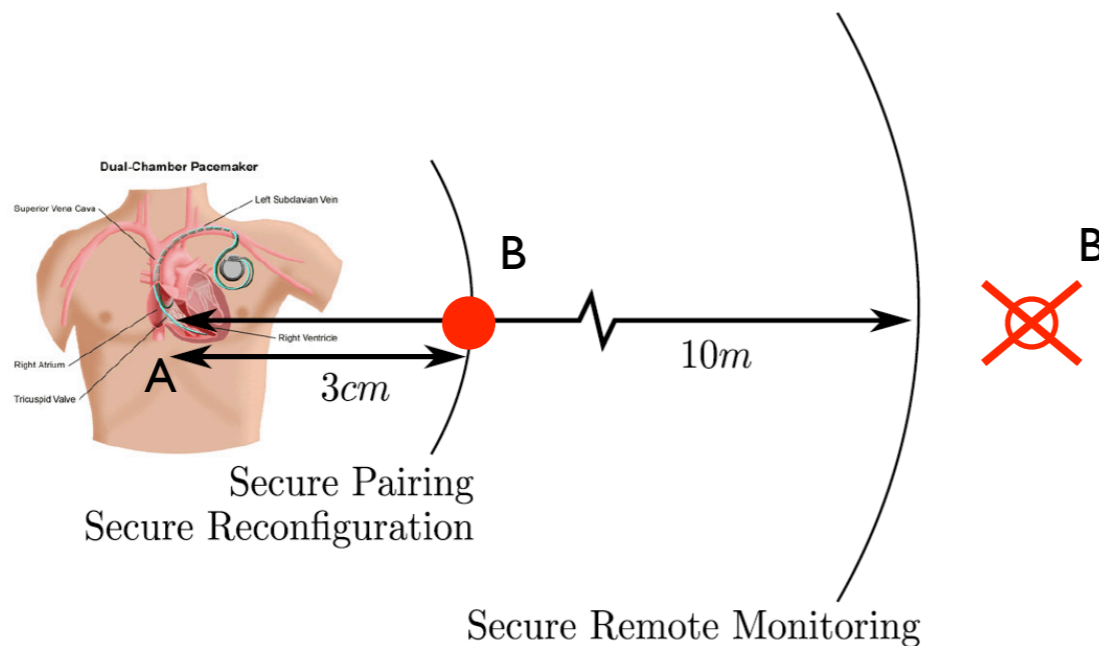

1. A verifies proximity of B
2. A establishes a *shared secret key* with B (e.g., pairing using DH)
3. The key is used to enforce access control

One Use of DB -> Authentication Based on *Absence* Awareness

How would Proximity-Based Access Control be implemented?

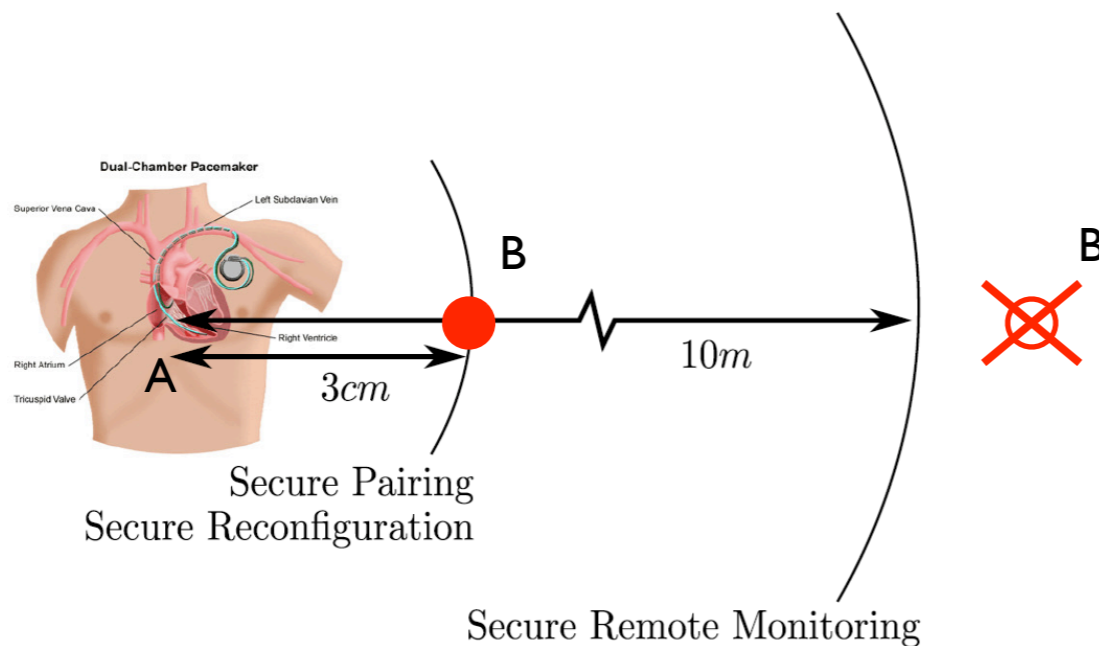

1. A verifies proximity of B
2. A establishes a *shared secret key* with B (e.g., pairing using DH)
3. The key is used to enforce access control

The protocol needs to ensure that the *key is bound to the distance*.

One Use of DB -> Authentication Based on *Absence* Awareness

How would Proximity-Based Access Control be implemented?

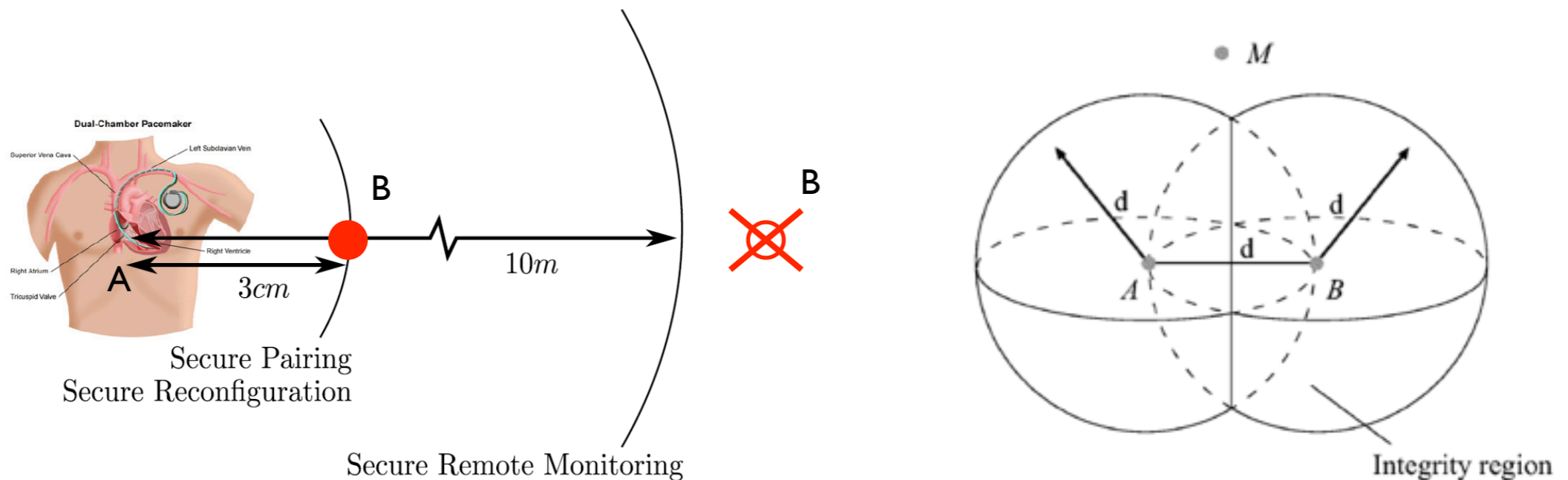

1. A verifies proximity of B
2. A establishes a *shared secret key* with B (e.g., pairing using DH)
3. The key is used to enforce access control

The protocol needs to ensure that the *key is bound to the distance*.

Secure Localization

*From Proximity Verification
to Location Verification and Secure Localization*

Secure Localization

User's perspective:

to obtain a correct information about its own location

Infrastructure perspective:

to obtain a correct information about the location of a device

Secure localization goals

- Compute a 'correct' location of a (trusted) device in the presence of an attacker. (*Secure Localization*)
- Verify the correctness of a location of an untrusted device. (that e.g., claims a certain location) (*Location Verification*)

Secure Localization Schemes

- Verifiable Multilateration
- Location Verification with Hidden and Mobile Stations
- *Secure Broadcast Localization and Time Synchronization*
(will be covered later in the lectures)

Distance Bounding

- P can always pretend to be further from V
- M can always convince P and V that they are further away

=> Distance enlargement is easy, distance reduction is prevented using distance bounding protocols

Ranging

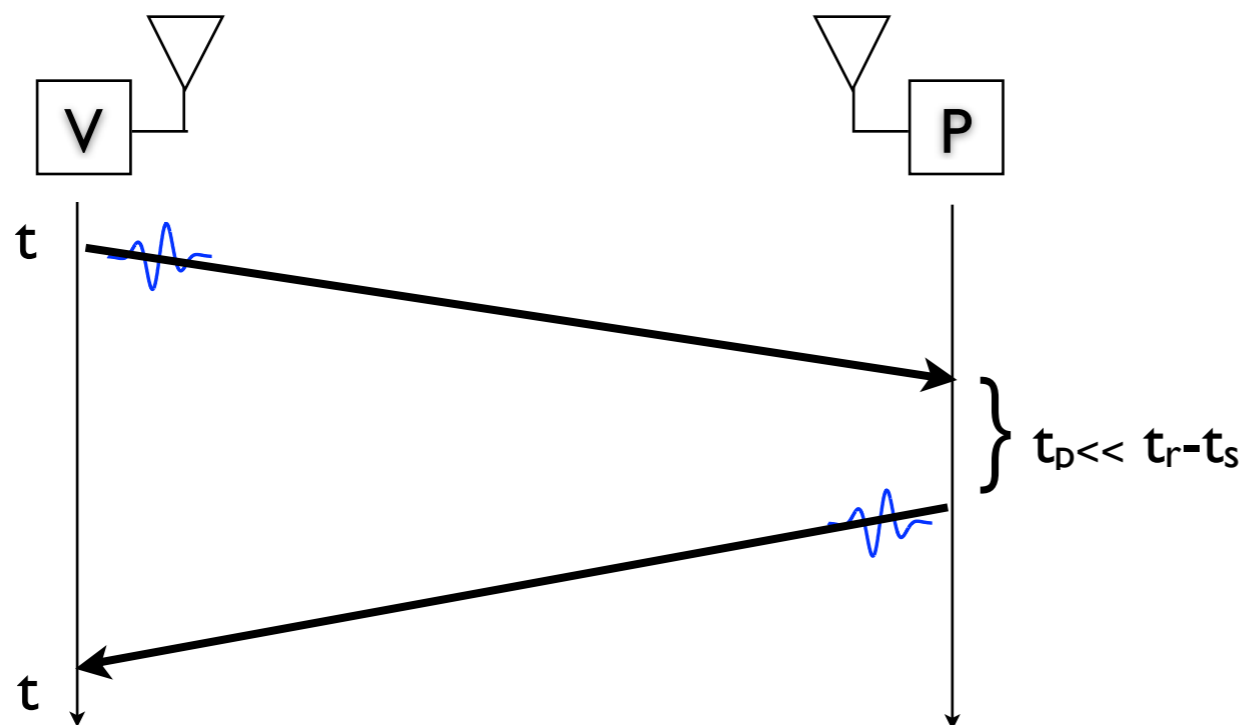

$$d = (t_r - t_s - t_p)c/2$$

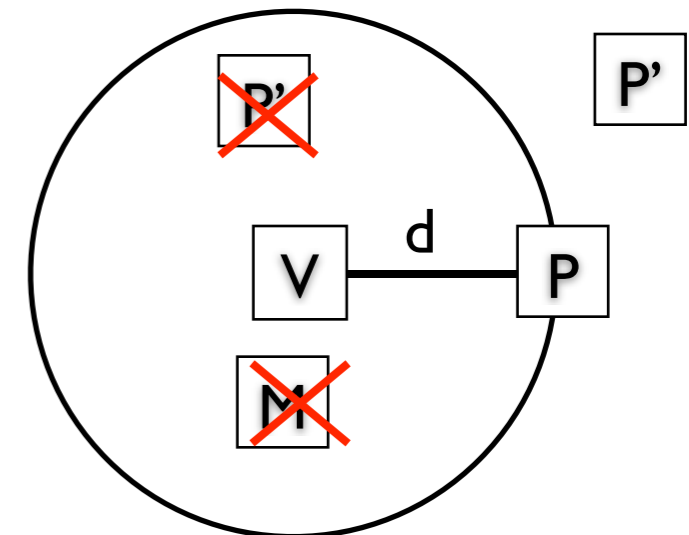

Distance Bounding

- P can always pretend to be further from V
- M can always convince P and V that they are further away

=> Distance enlargement is easy, distance reduction is prevented using distance bounding protocols

Ranging

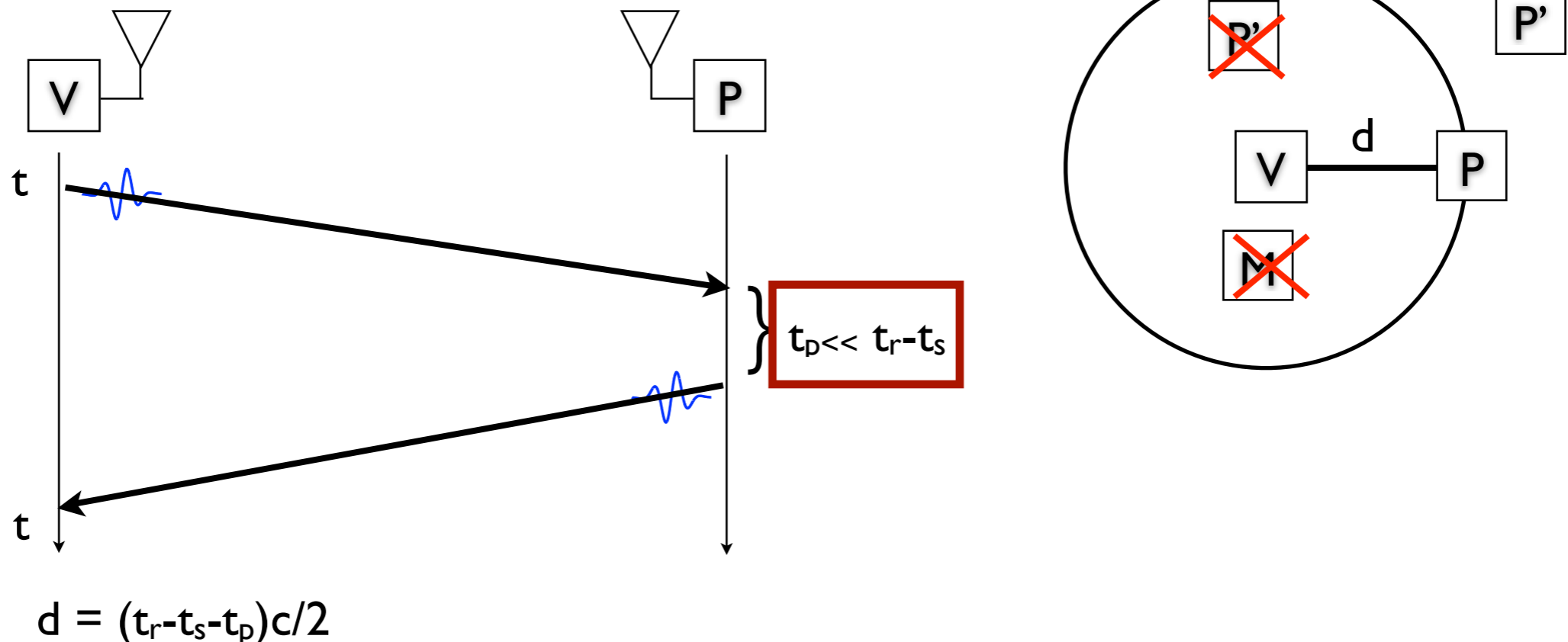

Distance Bounding

- P can always pretend to be further from V
- M can always convince P and V that they are further away

=> Distance enlargement is easy, distance reduction is prevented using distance bounding protocols

Ranging

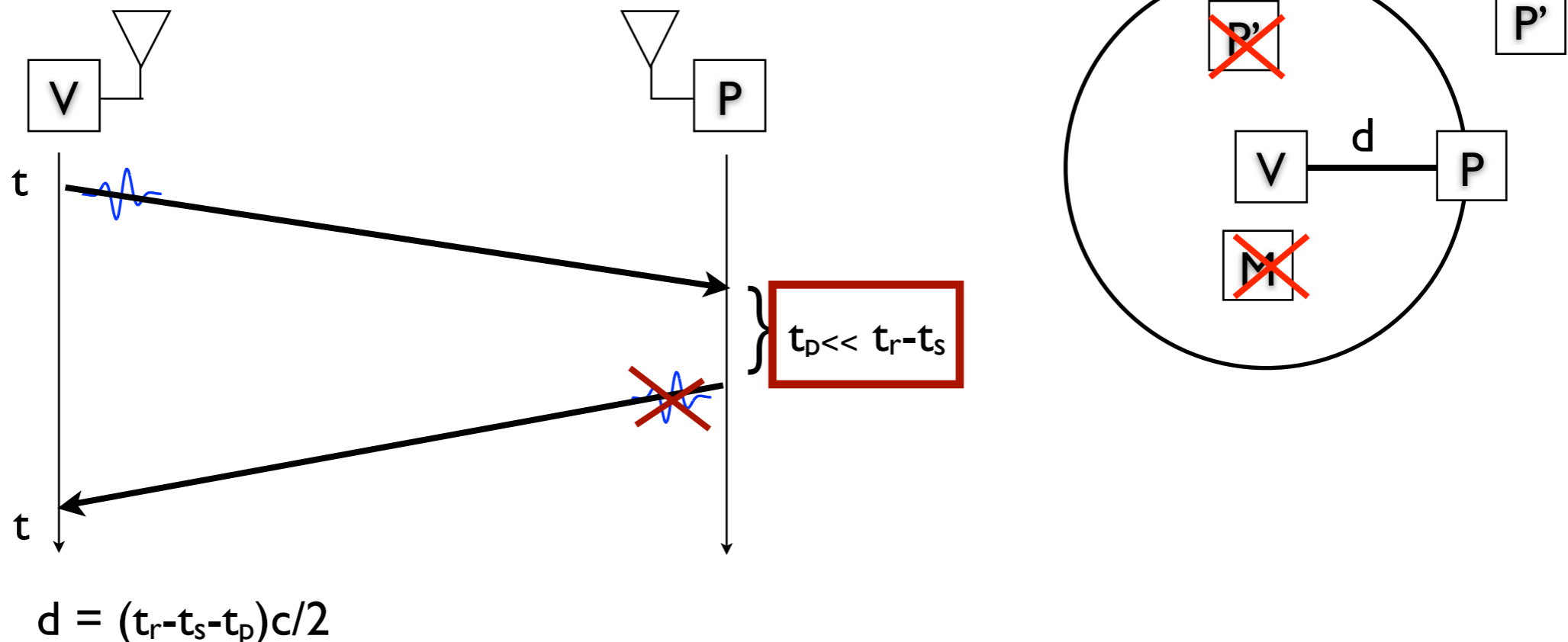

Distance Bounding

- P can always pretend to be further from V
- M can always convince P and V that they are further away

=> Distance enlargement is easy, distance reduction is prevented using distance bounding protocols

Ranging

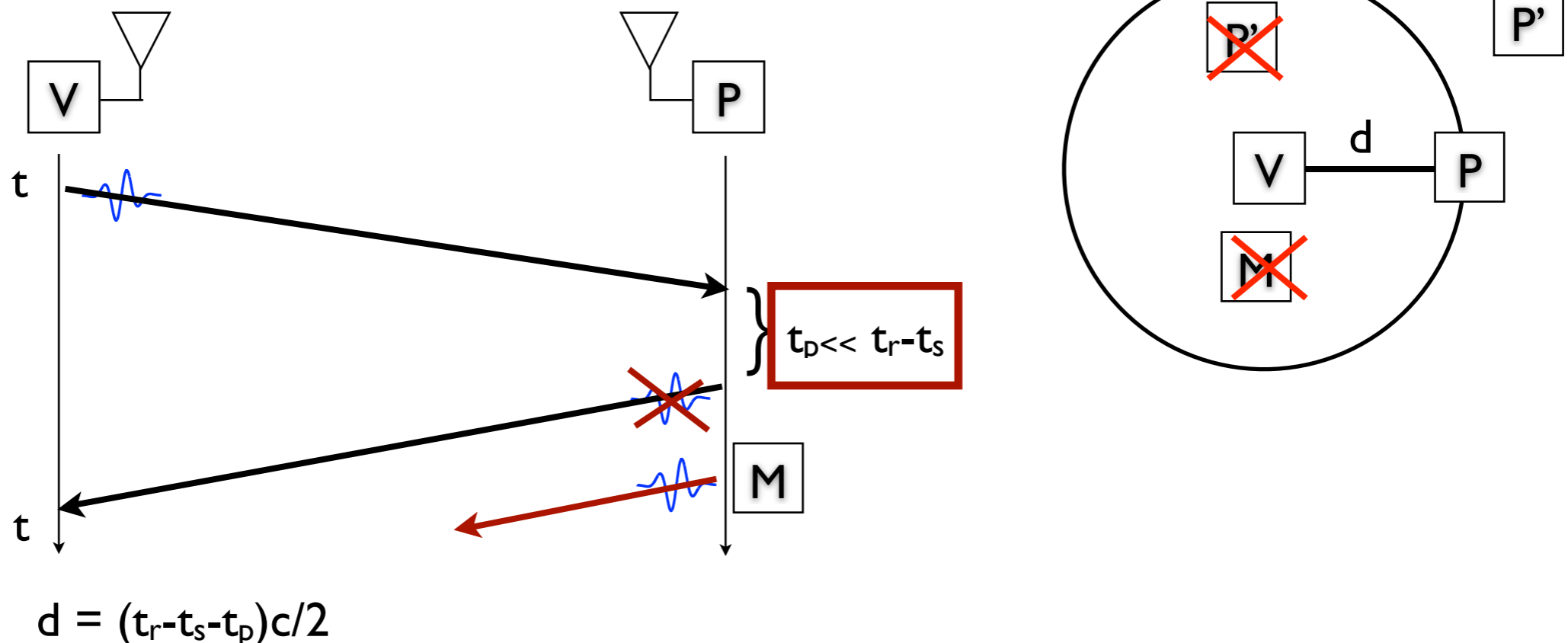

Verifiable Multilateration

Distance enlargement is easy, distance reduction is prevented using distance bounding protocols

- *So can we realize Location Verification or Secure Localization using Distance Bounding protocols?*

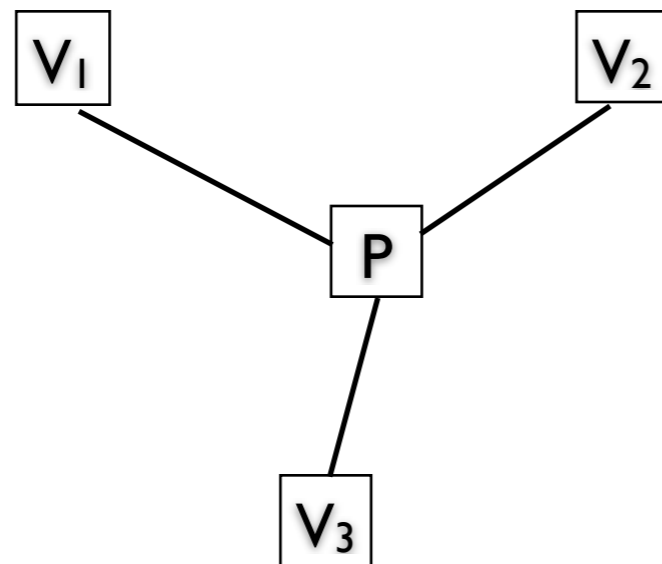

Verifiable Multilateration

Distance enlargement is easy, distance reduction is prevented using distance bounding protocols

- *So can we realize Location Verification or Secure Localization using Distance Bounding protocols?*

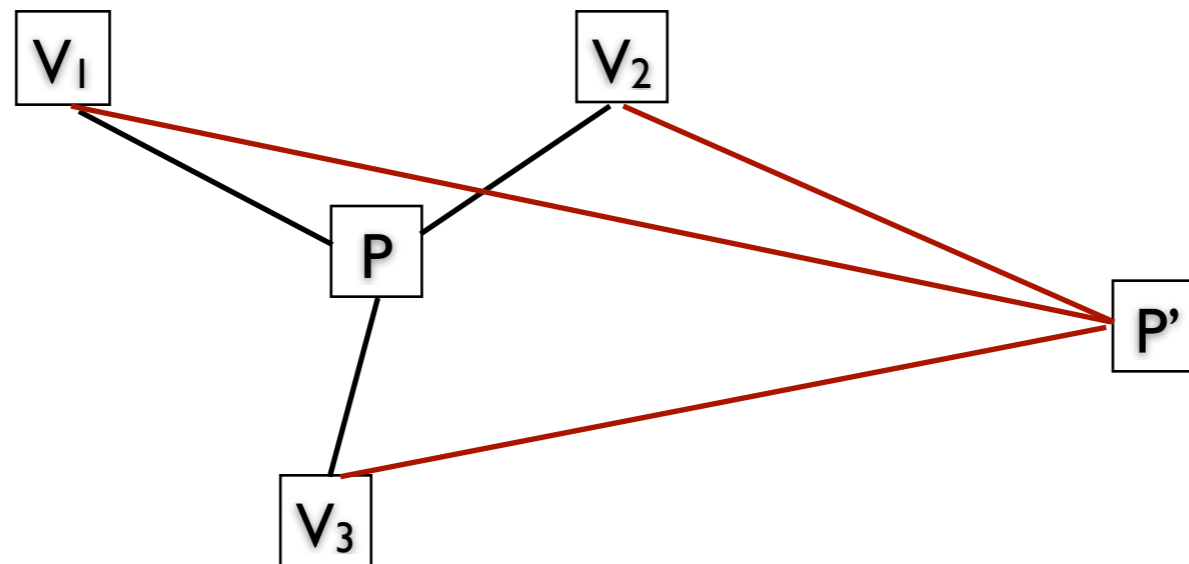

Verifiable Multilateration

Verifiable Multilateration in 3 steps:

1. Verifiers (known locations) form a *verification triangle*.
2. Based on the measured distance bounds, compute the location of the Prover.
3. *If the computed location is in the verification triangle, the verifiers conclude that this is a correct location.*

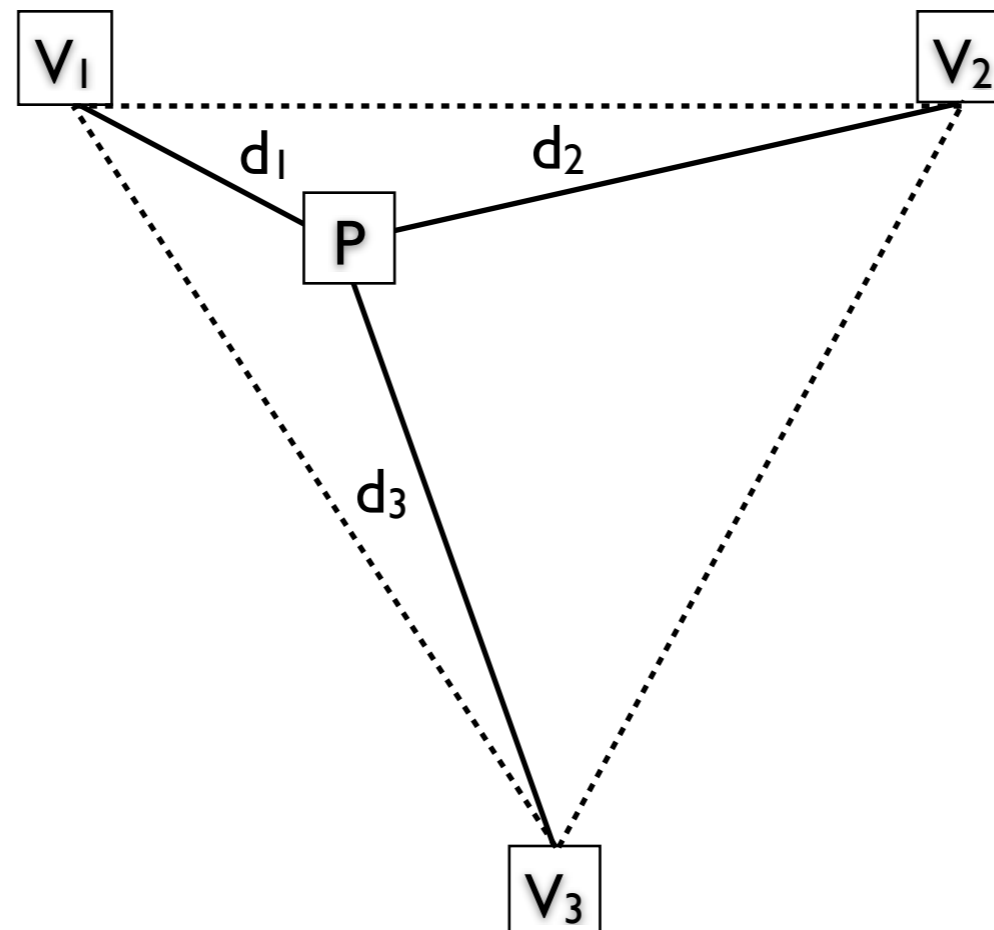

Verifiable Multilateration

Verifiable Multilateration in 3 steps:

1. Verifiers (known locations) form a *verification triangle*.
2. Based on the measured distance bounds, compute the location of the Prover.
3. *If the computed location is in the verification triangle, the verifiers conclude that this is a correct location.*

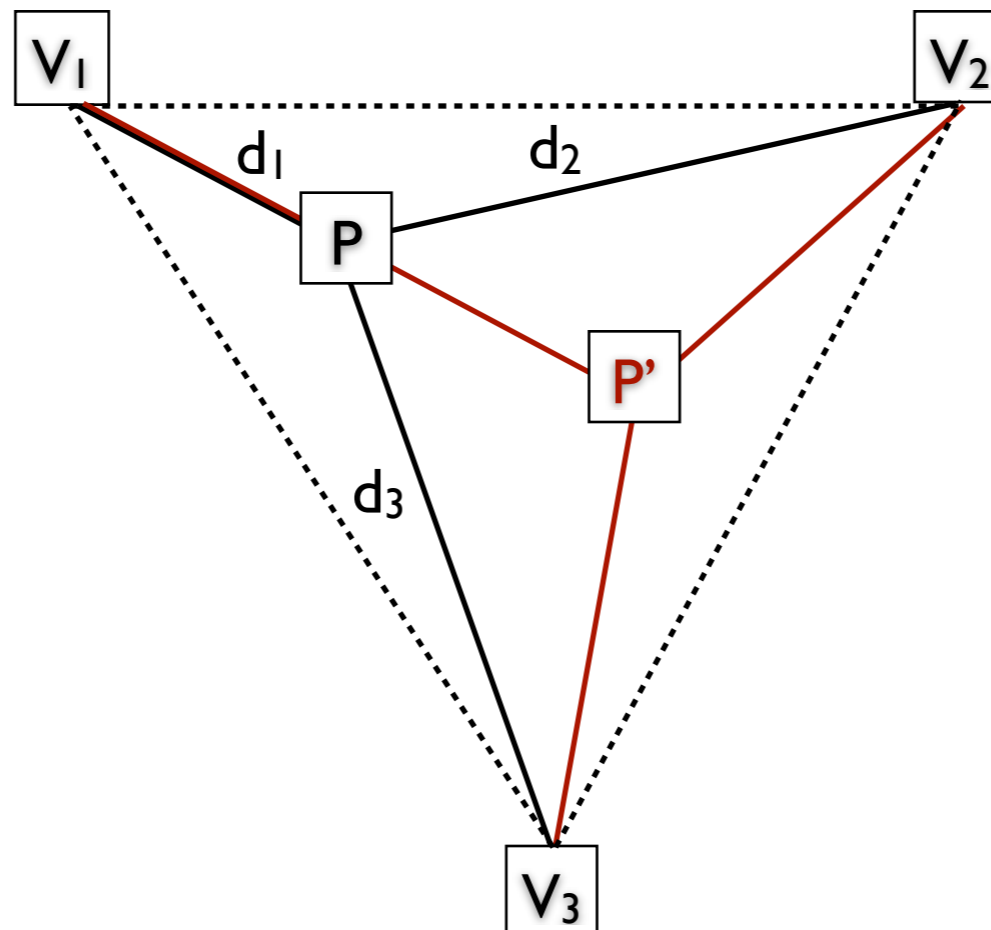

Verifiable Multilateration

Verifiable Multilateration in 3 steps:

1. Verifiers (known locations) form a *verification triangle*.
2. Based on the measured distance bounds, compute the location of the Prover.
3. *If the computed location is in the verification triangle, the verifiers conclude that this is a correct location.*

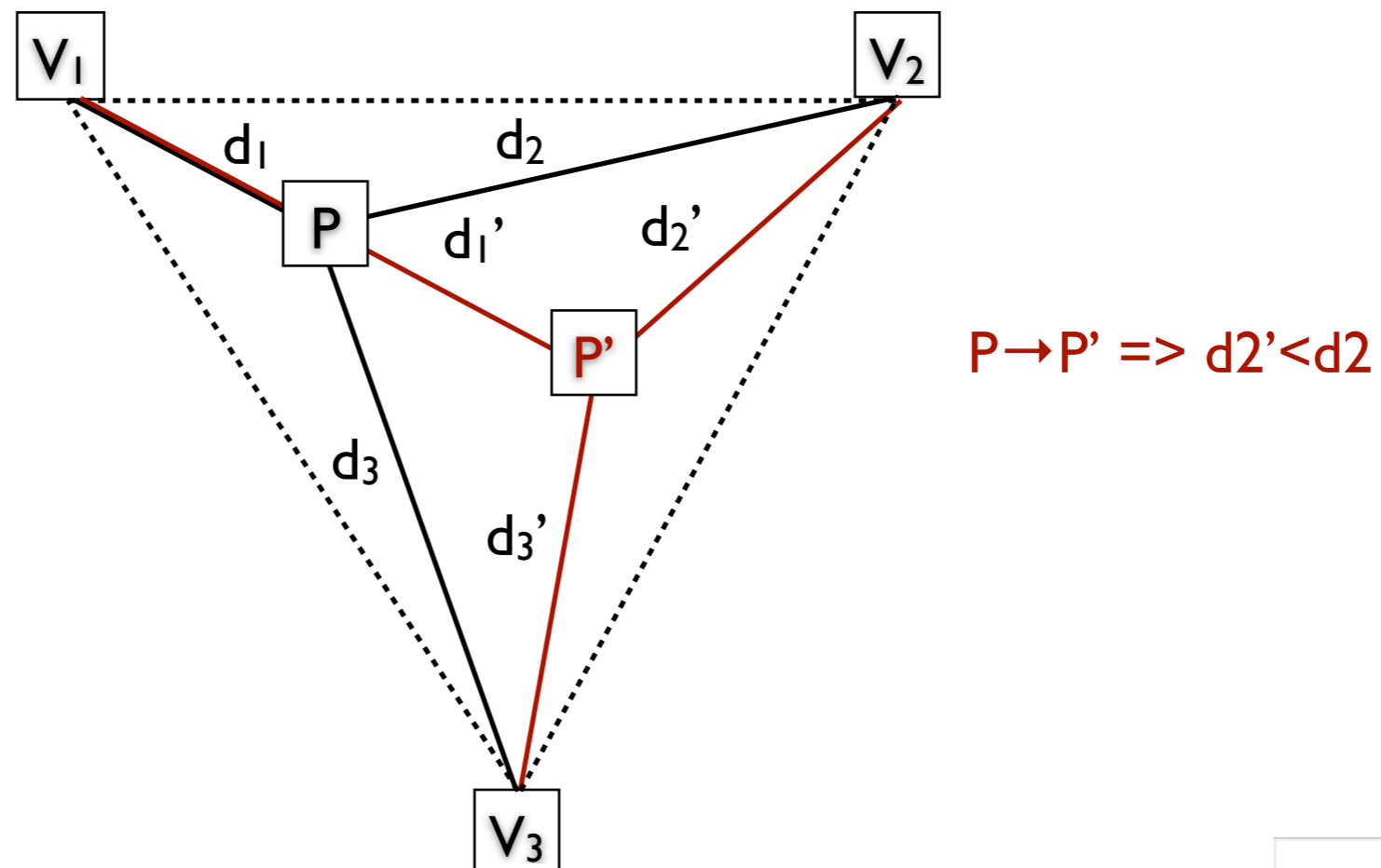

Verifiable Multilateration

Properties:

1. *P cannot successfully claim to be at $P' \neq P$, where P' is within the triangle*
2. *M cannot convince Vs and P that P is at $P' \neq P$ where P' is within the triangle*
3. *P or M can spoof a location from P to P' where P' is outside the triangle*

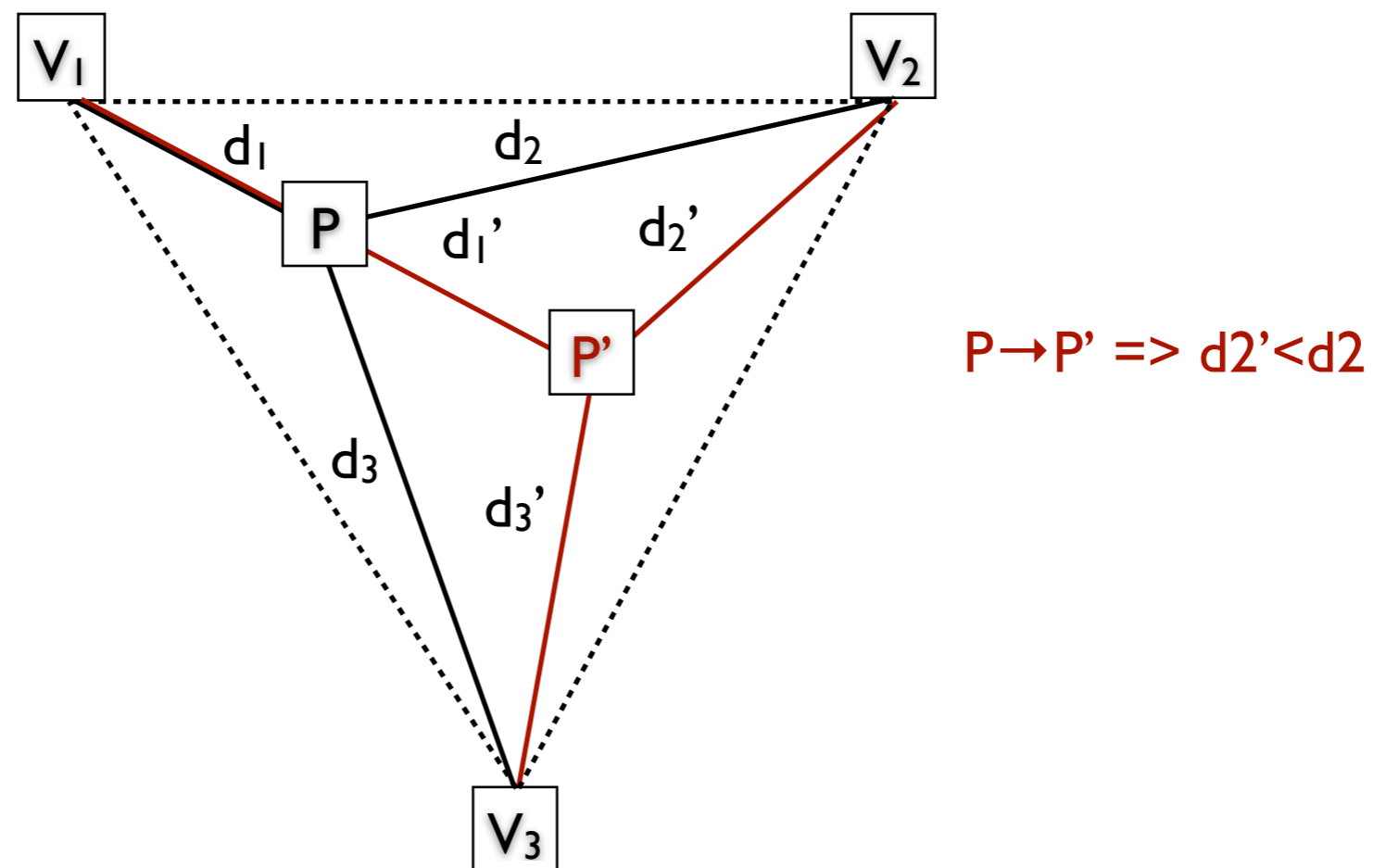

Verifiable Multilateration

The algorithm and the errors:

- Need to be careful how the position is computed!
- Example: *Minimum Mean Square Estimate (MMSE)*

$$\text{Let } f_i(x'_u, y'_u) = db_i - \sqrt{(x_i - x'_u)^2 + (y_i - y'_u)^2}$$

The position of u is obtained by minimizing
 $F(x'_u, y'_u) = \sum_{v_i \in \mathcal{T}} f_i^2(x'_u, y'_u)$
over all estimates of u

- *Attack:*

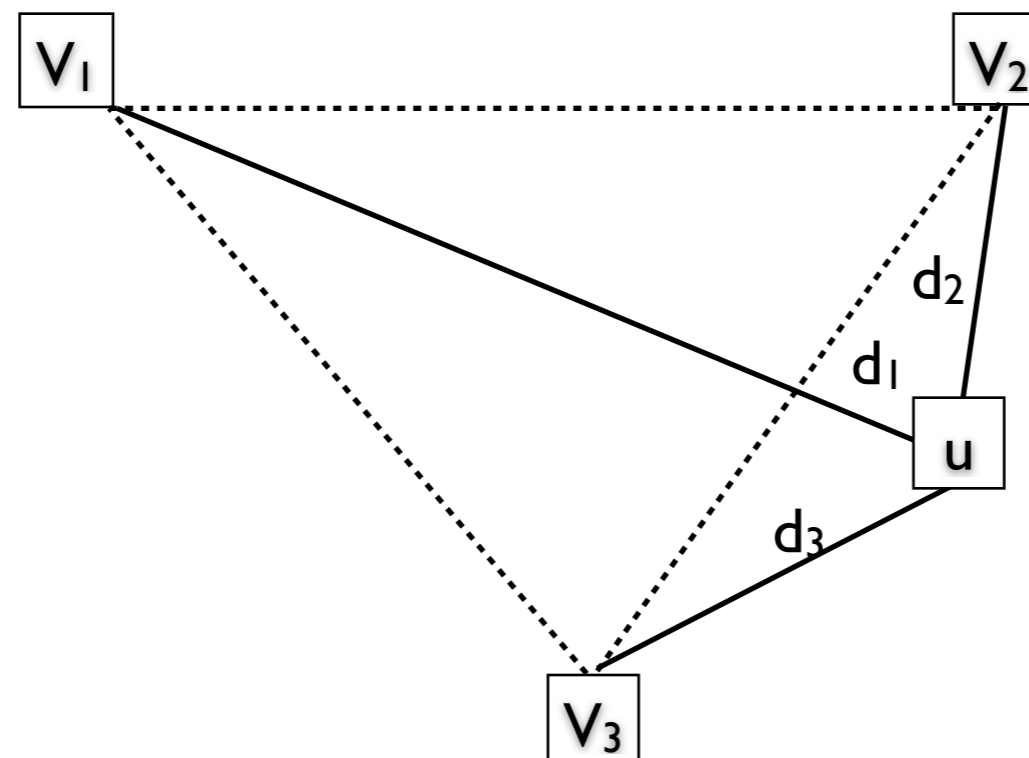

Verifiable Multilateration

The algorithm and the errors:

- Need to be careful how the position is computed!
- Example: *Minimum Mean Square Estimate (MMSE)*

$$\text{Let } f_i(x'_u, y'_u) = db_i - \sqrt{(x_i - x'_u)^2 + (y_i - y'_u)^2}$$

The position of u is obtained by minimizing
 $F(x'_u, y'_u) = \sum_{v_i \in \mathcal{T}} f_i^2(x'_u, y'_u)$
over all estimates of u

- *Attack:*

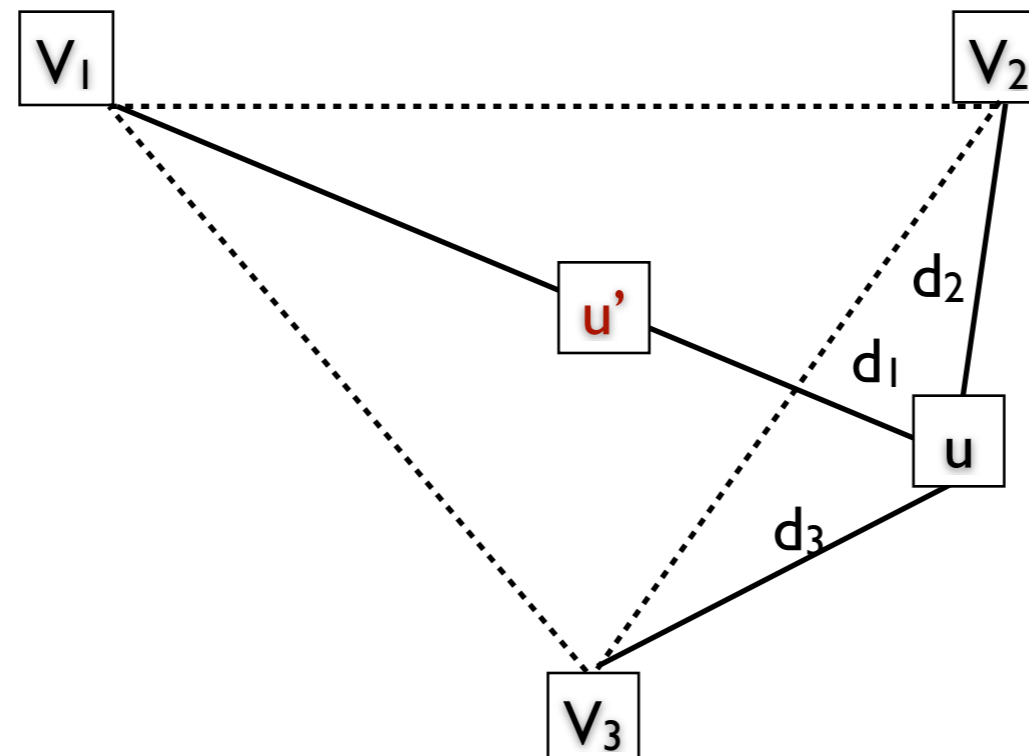

Verifiable Multilateration

The algorithm and the errors:

- Need to be careful how the position is computed!
- Example: *Minimum Mean Square Estimate (MMSE)*

$$\text{Let } f_i(x'_u, y'_u) = db_i - \sqrt{(x_i - x'_u)^2 + (y_i - y'_u)^2}$$

The position of u is obtained by minimizing
 $F(x'_u, y'_u) = \sum_{v_i \in \mathcal{T}} f_i^2(x'_u, y'_u)$
over all estimates of u

- *Attack:*

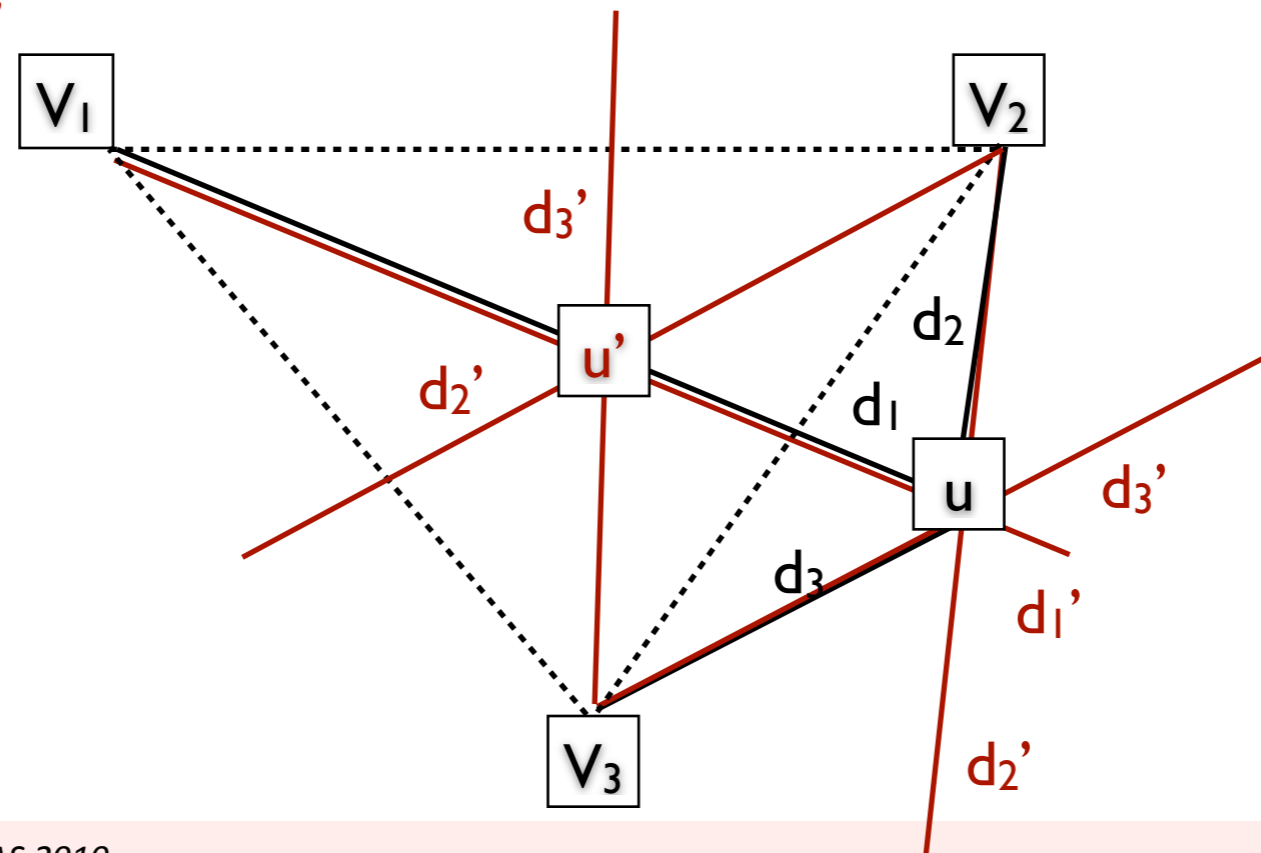

Verifiable Multilateration

Verifiable Multilateration Algorithm

$\mathcal{T} = \emptyset$; set of verification triangles enclosing u

$\mathcal{V} = \{v_1, \dots, v_n\}$; set of verifiers in the power range of u

1 For all $v_i \in \mathcal{V}$, perform distance bounding

from v_i to u and obtain db_i

2 With all $v_i \in \mathcal{V}$, compute the estimate (x'_u, y'_u) of the position by MMSE

3 If for all $v_i \in \mathcal{V}$, $|db_i - \sqrt{(x_i - x'_u)^2 + (y_i - y'_u)^2}| \leq \delta$ then

for all $(v_i, v_j, v_k) \in \mathcal{V}^3$, if $(x'_u, y'_u) \in \Delta(v_i, v_j, v_k)$

then $\mathcal{T} = \mathcal{T} \cup (v_i, v_j, v_k)$

if $|\mathcal{T}| > 0$ then position is accepted and $x_u = x'_u, y_u = y'_u$

else the position is rejected

else the position is rejected

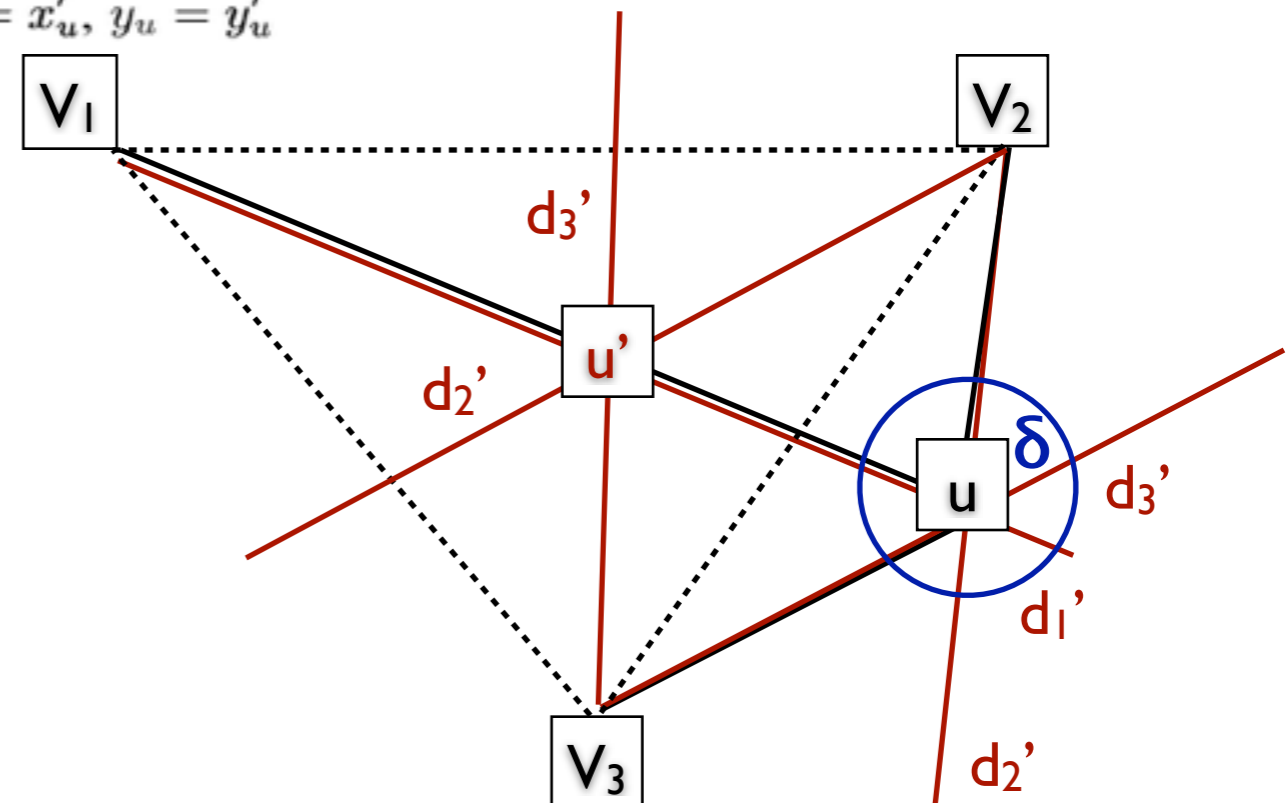

Verifiable Multilateration

Collusion attacks (only with untrusted prover under location verification)

- *Attack:*

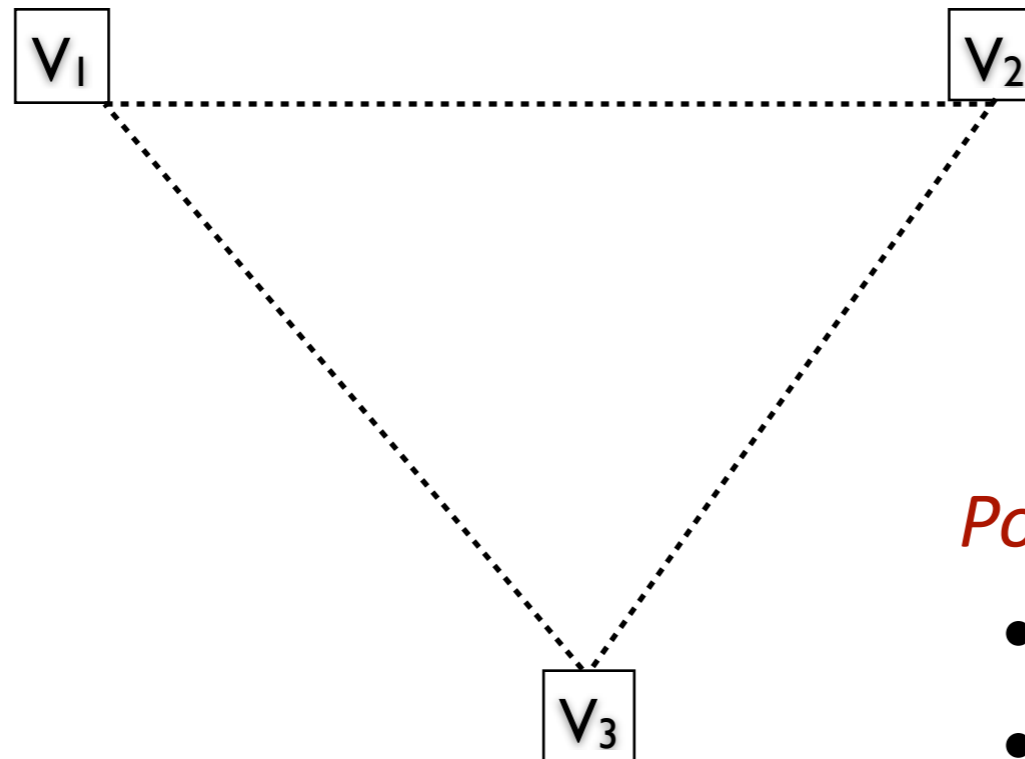

Possible protections:

- Tamper Resistance
- Device Identification

Verifiable Multilateration

Collusion attacks (only with untrusted prover under location verification)

- *Attack:*

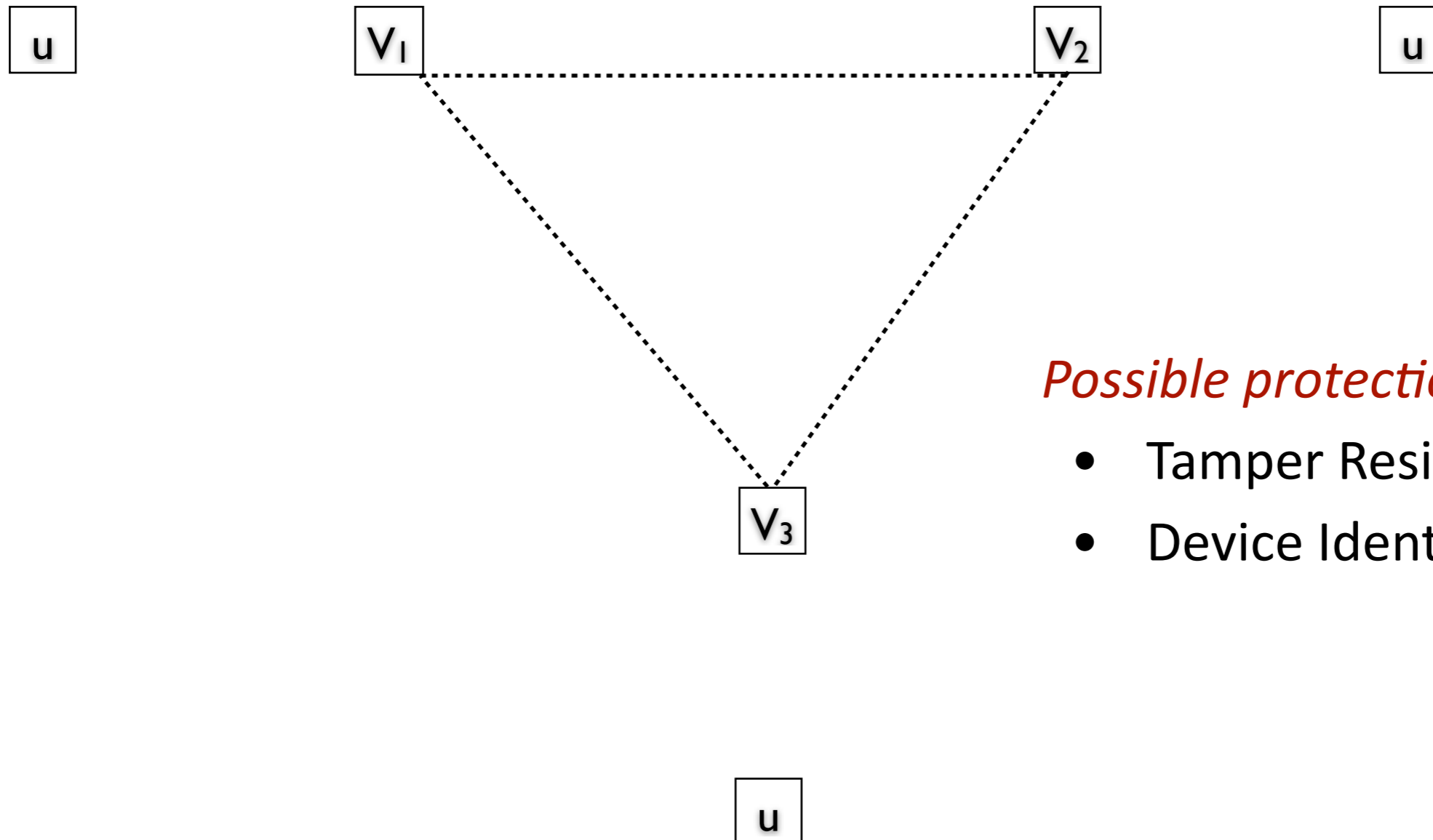

Possible protections:

- Tamper Resistance
- Device Identification

Verifiable Multilateration

Collusion attacks (only with untrusted prover under location verification)

- *Attack:*

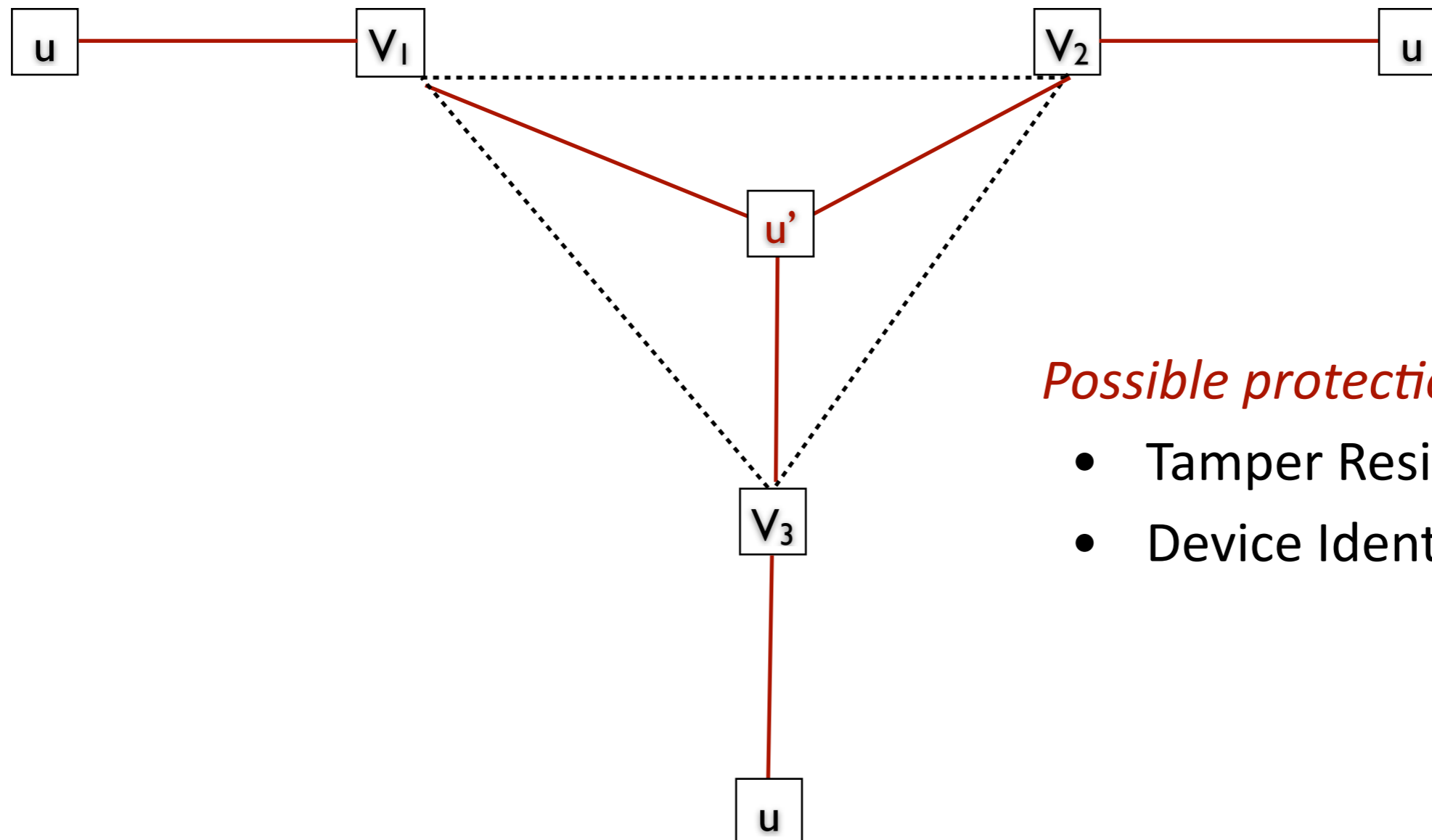

Possible protections:

- Tamper Resistance
- Device Identification

Verifiable Multilateration

Collusion attacks (only with untrusted prover under location verification)

- *Attack:*

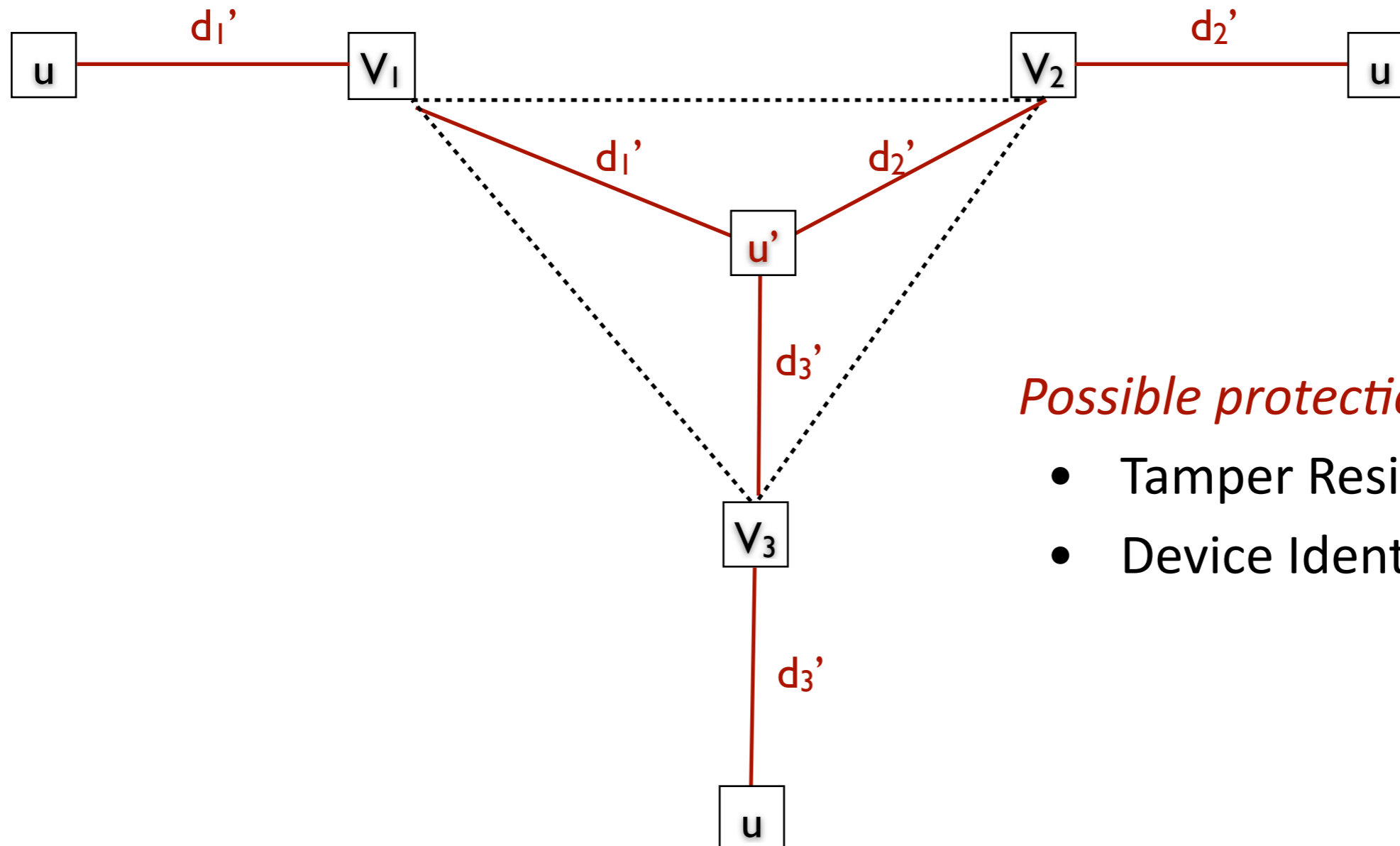

Possible protections:

- Tamper Resistance
- Device Identification

Location Verification using Hidden and Mobile Stations (*Verifiers*)

The basic idea:

- *If the prover does not know where the verifiers are, it doesn't know how to cheat.*

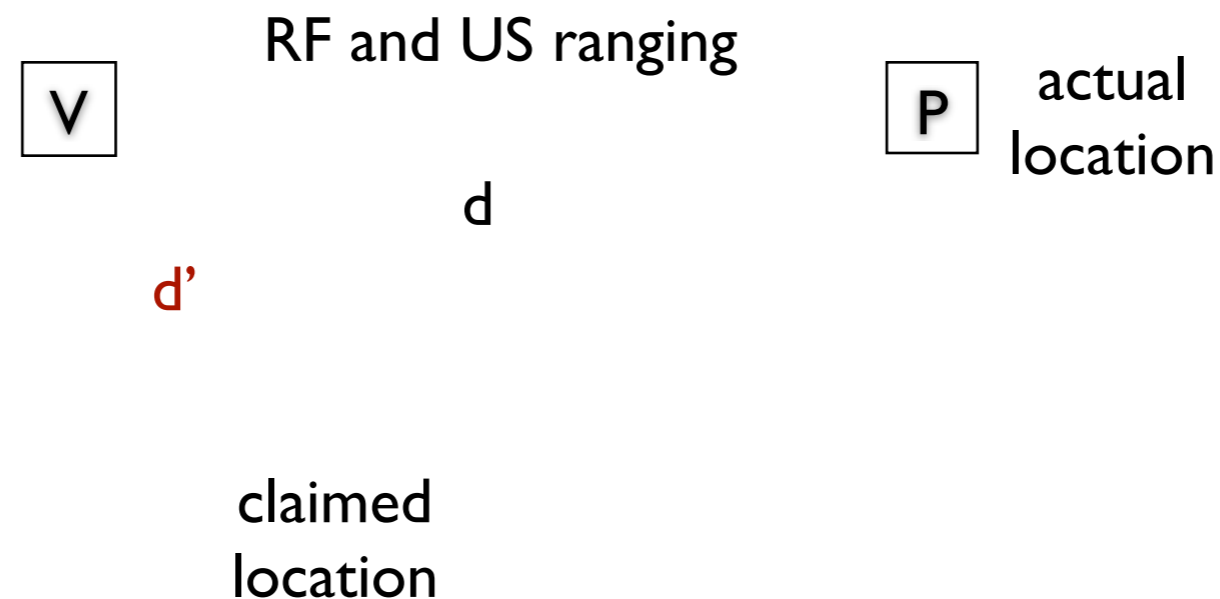

$$p(\text{successful cheating}) = p(d-d' \leq \Delta)$$

where Δ is the ranging/localization accuracy

Location Verification using Hidden and Mobile Stations (*Verifiers*)

The basic idea:

- *If the prover does not know where the verifiers are, it doesn't know how to cheat.*

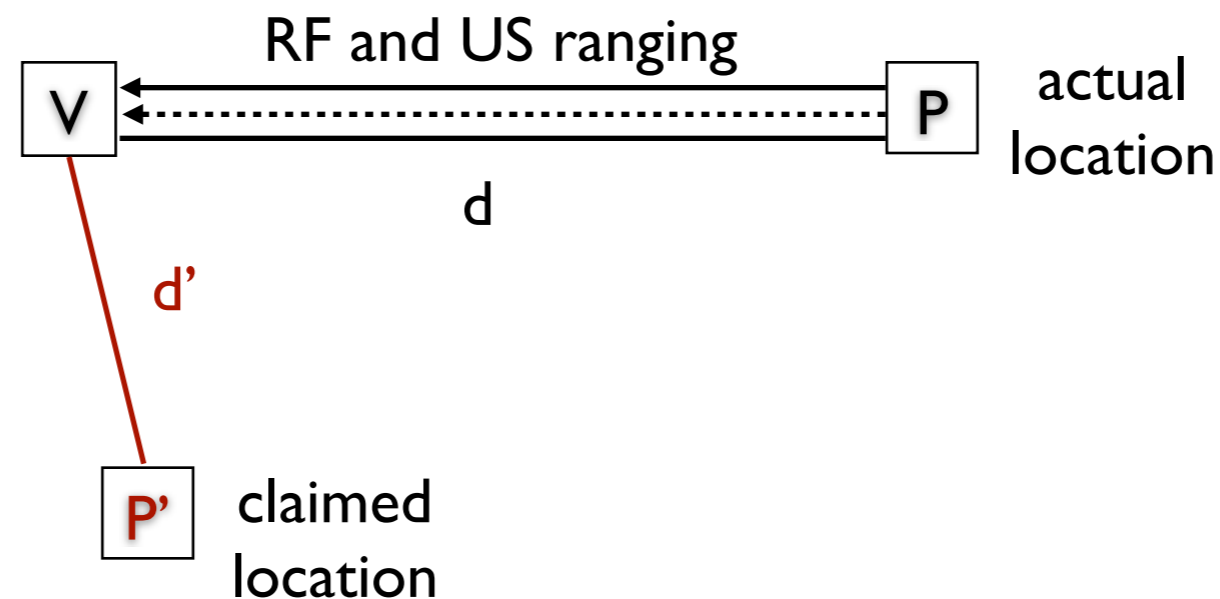

$$p(\text{successful cheating}) = p(d-d' \leq \Delta)$$

where Δ is the ranging/localization accuracy

Location Verification using Hidden and Mobile Stations (*Verifiers*)

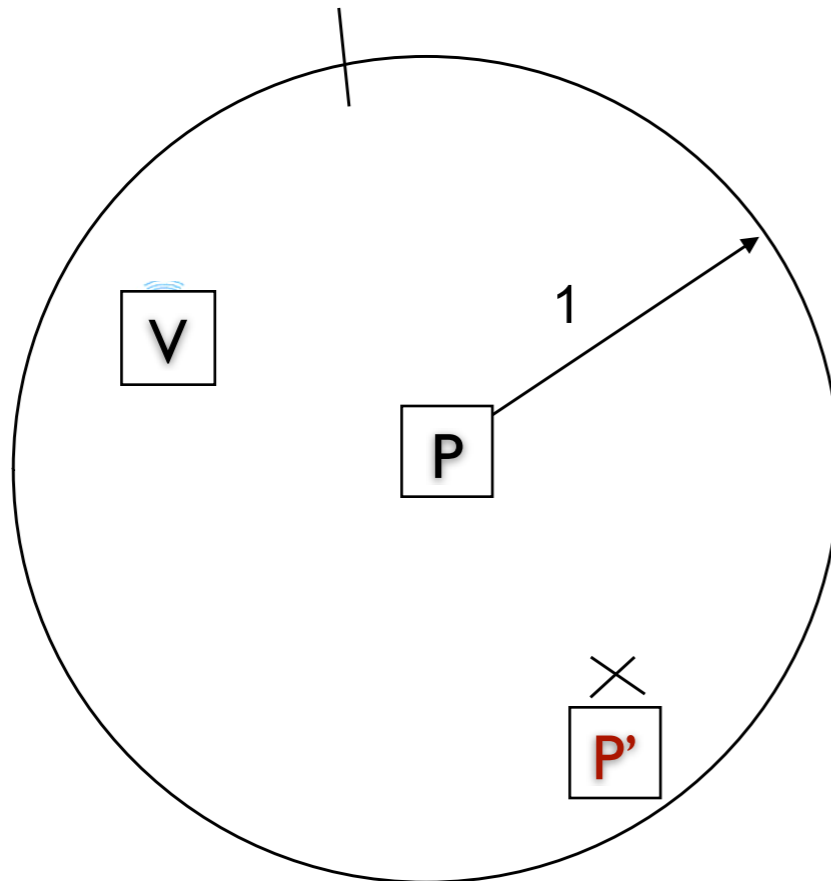

Observation 1:

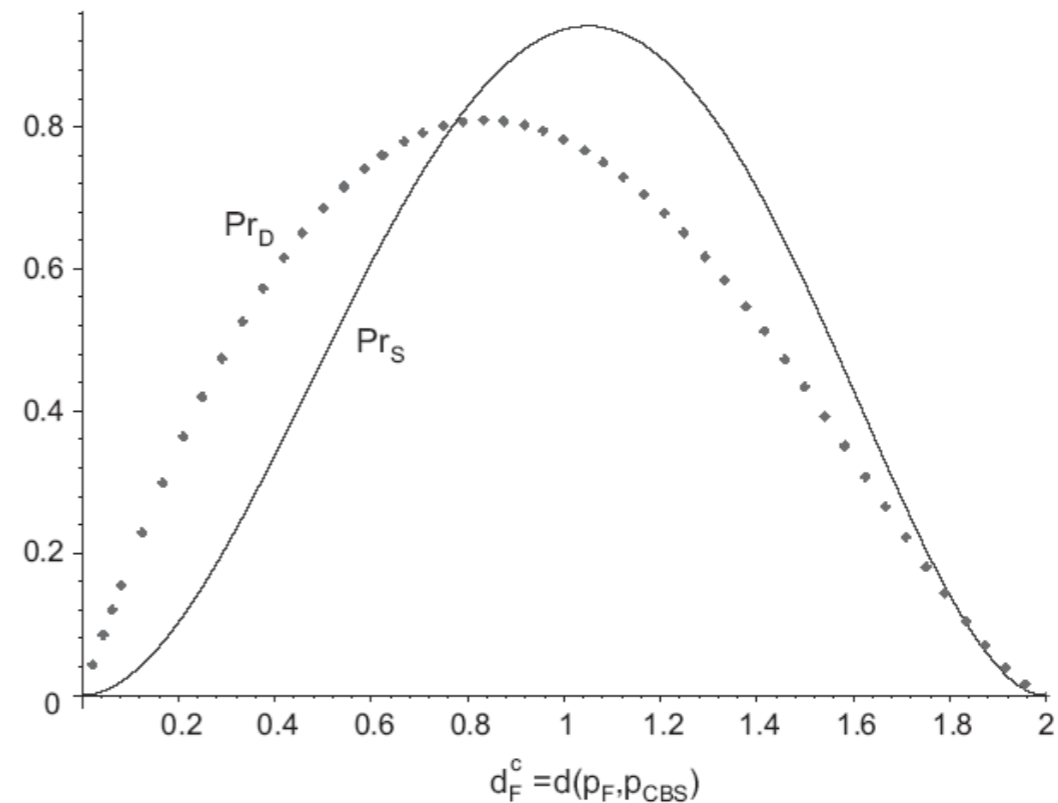

not all distances are equally likely

- Not all locations are equally easy to fake (center is the 'easiest').
- *Problems if the attacker knows where verifiers cannot be.*

Summary (on secure localization)

Main ideas

- Use time as a side-channel (e.g., distance bounding)
- Use hidden verifier locations
- Use spread spectrum communication (hide the signals such that they cannot be manipulated - in time)

- References:
 - Verifiable Multilateration:
S. Capkun, J. P. Hubaux, Secure positioning in wireless networks, IEEE Journal on Selected Areas in Communications: Special Issue on Security in Wireless Ad Hoc Networks, February 2006.
 - <http://www.syssec.ethz.ch/research/spot>

Summary

- Secure Localization / Location Verification is a fascinating area
- Brings up interesting interactions between logical and physical layer
- New challenges in formal protocol analysis
- Can be used for Secure Localization and Location Verification
- Numerous Applications
 - Physical and Logical Access Control, Anti-Spoofing, Protection of Networking Functions, ...

