

AI-assisted decision support for operational planning in distribution systems



<https://aisoproject.com>

AI4Grids Symposium
HTWG Konstanz

29. September 2023



Funding Partners



Smart
Energy
Systems
ERA-Net



This initiative has received funding from the European Union's Horizon 2020 research and innovation programme under grant agreements no. 646039, no. 775970 and no. 883973.



ADEME

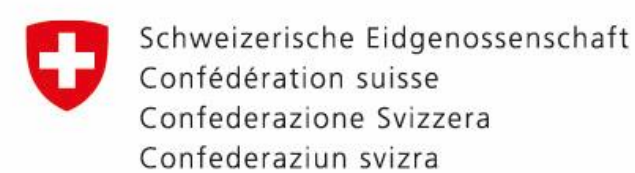

Swiss Federal Office of Energy SFOE



FOND ZA ZAŠTITU OKOLIŠA I ENERGETSKU UČINKOVITOST



Agence de l'Environnement et de la Maîtrise de l'Énergie

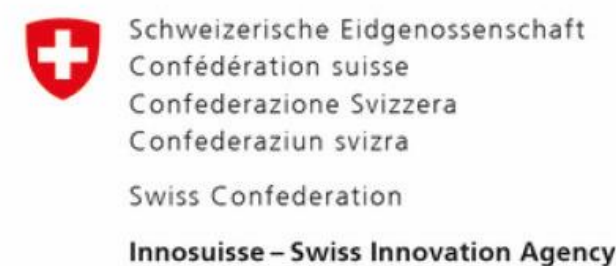



Das AISOP Konsortium

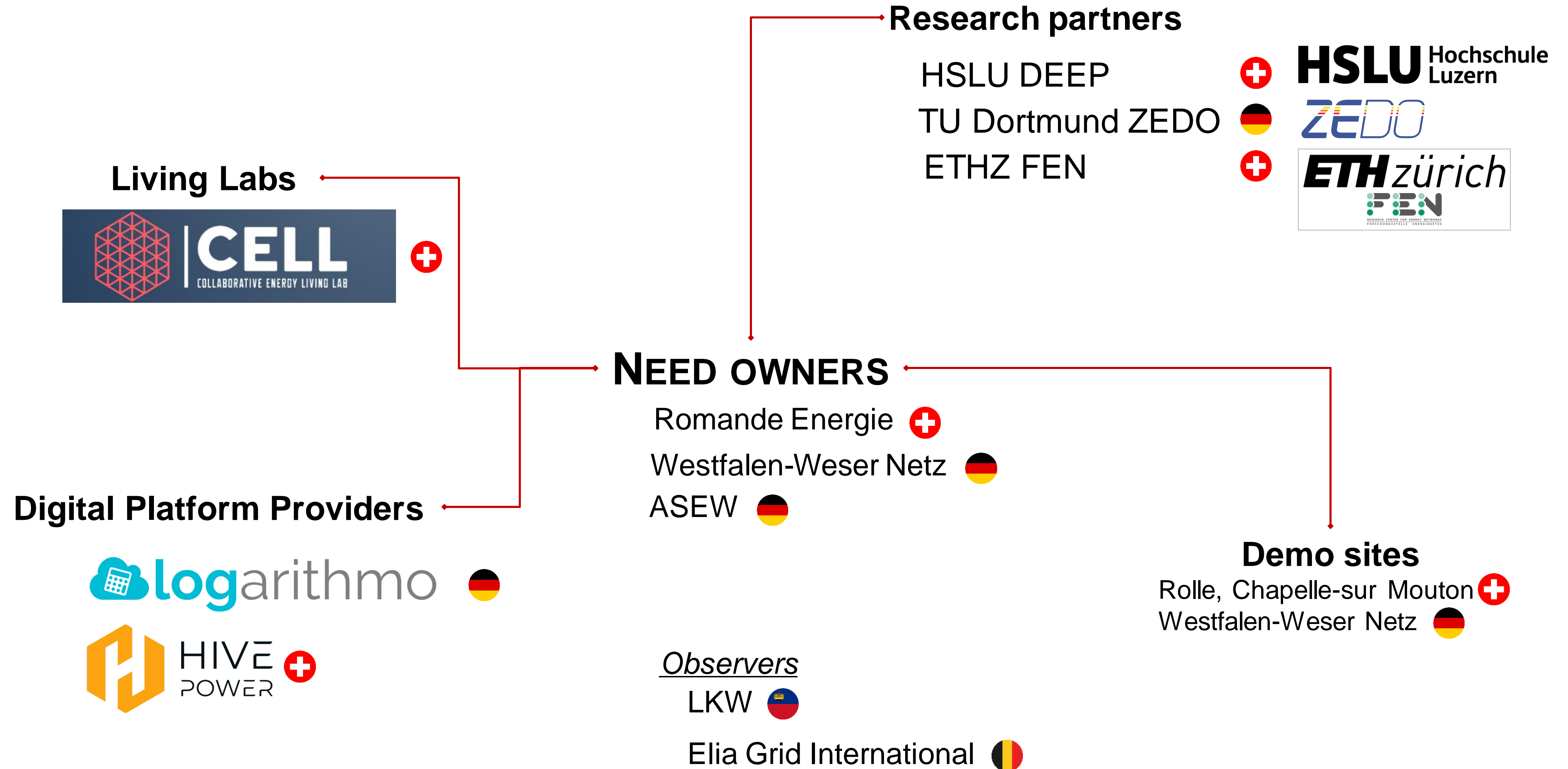



Was heisst Betriebsplanung im Übertragungsnetz?

fr it en

swissgrid

Planning grid operation

Prevent congestion in the grid with long-term planning

The operation of the transmission grid is based on long-term planning. The operators in the grid control room in Aarau use a grid model to prepare an initial forecast of the grid situation over a year in advance. This planning considers events such as repairs of power plants or lines; decommissioning grid elements and capacity constraints.

Motivation

- ❖ Smart Meter Roll-out
- ❖ Neue Datenquellen
- ❖ Veränderungen oft und näher zu real-time
- ❖ Automatisierung in Betrieb

The planning of the grid operation is refined on an ongoing basis: **the expected grid situation is constantly recalculated one year, one month, one week, two days and one day before real-time operation.** For instance, the operators calculate the cross-border capacity that can be made available for electricity trade two days before live operation. One day before, the operators update their planning based on the schedules provided by power plants and electricity traders, which contain both domestic and international electricity trading transactions. The grid control room works together with the grid operators in neighbouring countries to check whether the grid and the international interconnection lines can transmit the produced and traded volume of energy, where congestion exists, and the action that needs to be taken.

AISOP zielt darauf ab, ein **KI-gestütztes Entscheidungsunterstützungssystem für Verteilnetzbetreiber (DSO)** zu schaffen, um den Prozess der Betriebsplanung zu begleiten.

Outcomes	<p>Curative or proactive congestion management</p> <p>Day-ahead (or x-hour-ahead) preparation for probable events – based on forecasts: weather, solar generation</p> <p>Feeder reconfiguration: emulating (n-1) redundancy</p> <p>Voltage management (distributed or decentralised)</p> <p>Online security assessment</p>
-----------------	--

Value	<p>Investment deferral</p> <p>Fault location isolation and system restoration</p> <p>Identification and forecasting new loads (i.e., HP, EV charging) and solar generation</p> <p>Coordinating, designing (or helping to design) market or tariff mechanisms</p> <p>Providing services (e.g., Redispatch 2.0 in Germany: DSO contributing to redispatch)</p> <p>Coordination of utilization of resources in distribution</p> <p>Component monitoring and predictive maintenance</p> <p>Sustaining scarcity / autarky</p>
--------------	--

Tasks	<p>Assimilating data from smart meters and grid sensors</p> <p>Managing information security</p> <p>Assessment of available flexibility and load flexibility controls: ripple control, load shifting</p> <p>Assessment of network configuration changes (switches, tap changer-equipped substation)</p> <p>DSO-DSO-TSO interactions</p>
--------------	---

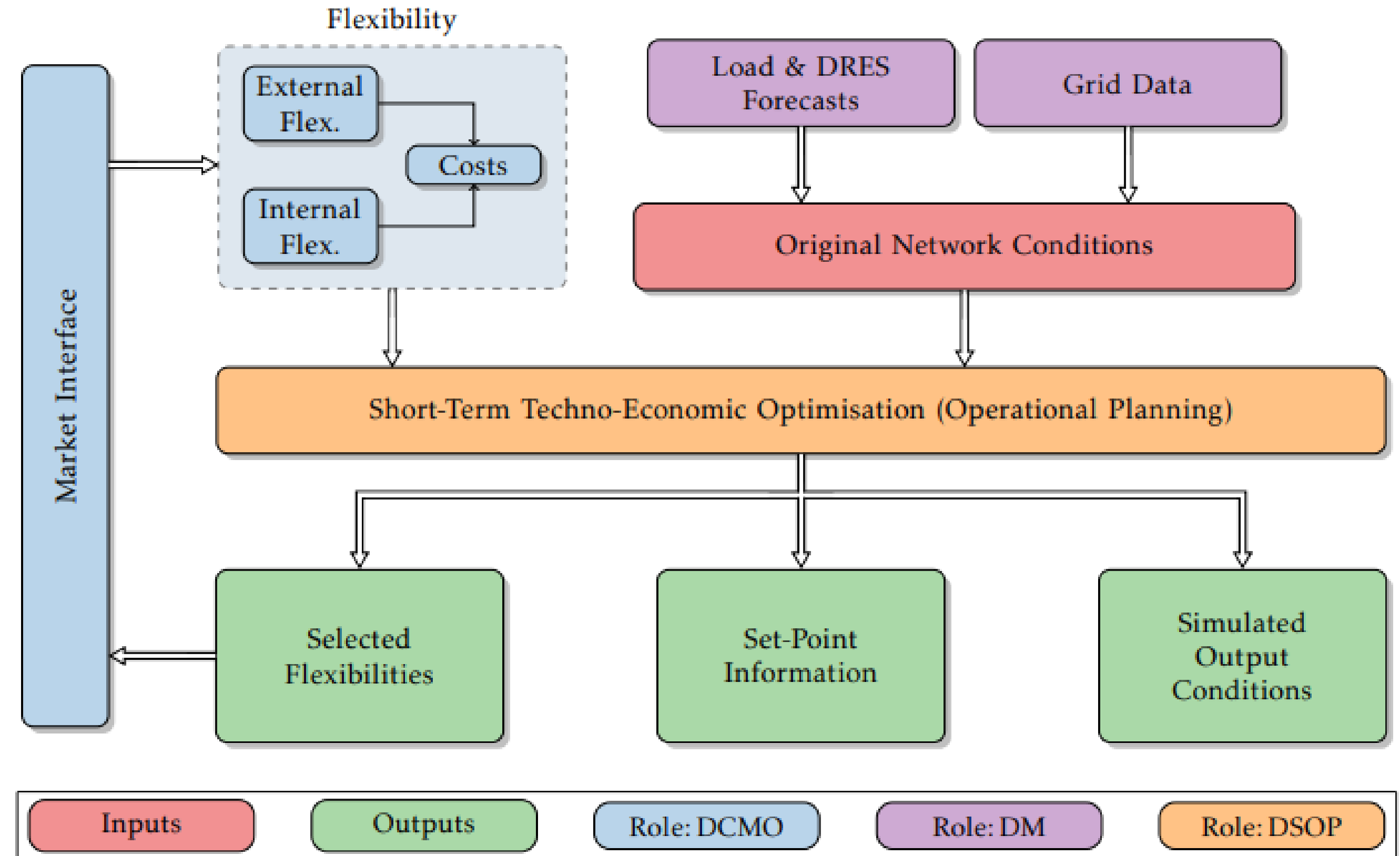
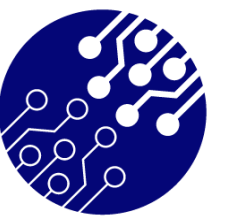
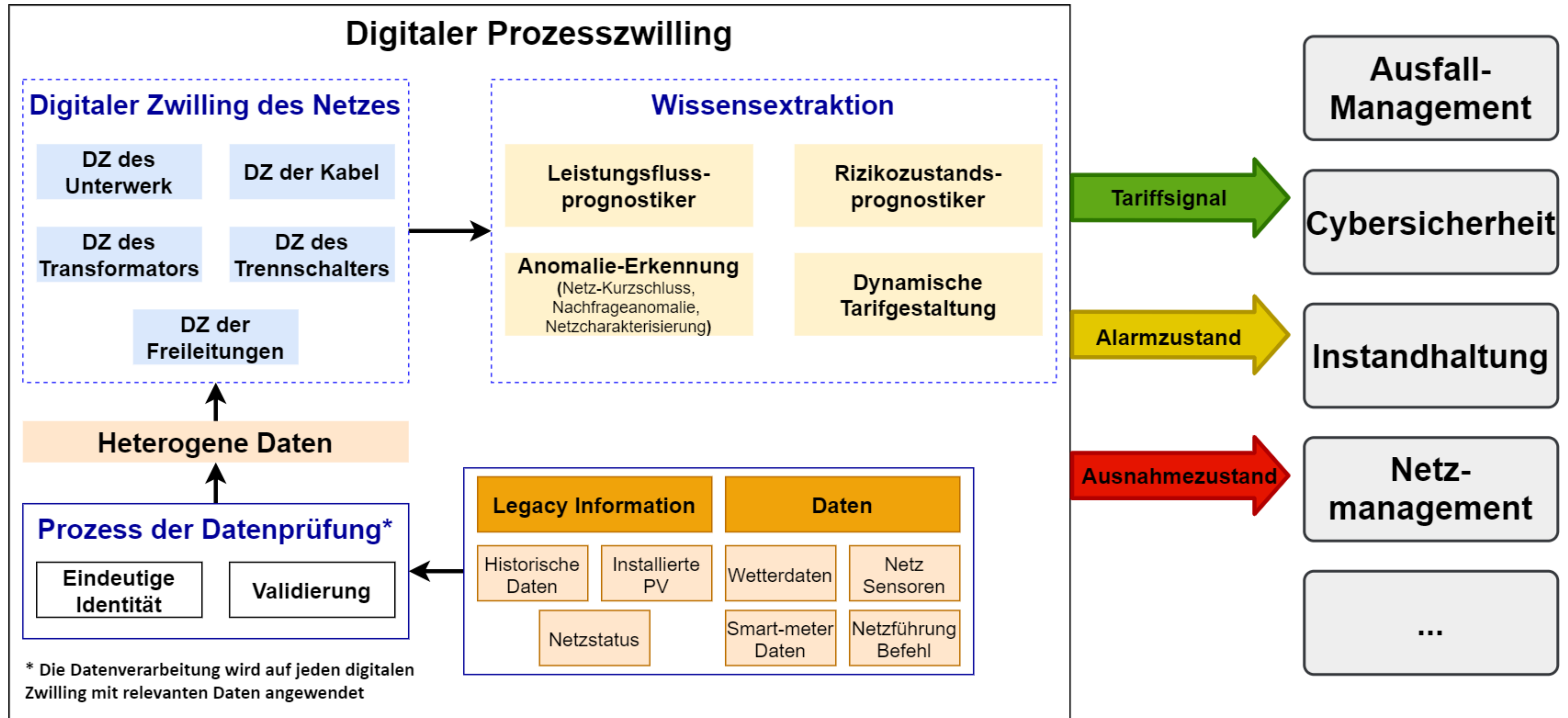

Figure 2.19: Typical Framework for Operational Planning in ADN

<https://tel.archives-ouvertes.fr/tel-01690509/document>



Digitaler Zwilling in der Netz- und Elektrizitätswirtschaft*





Ansatz AISOP

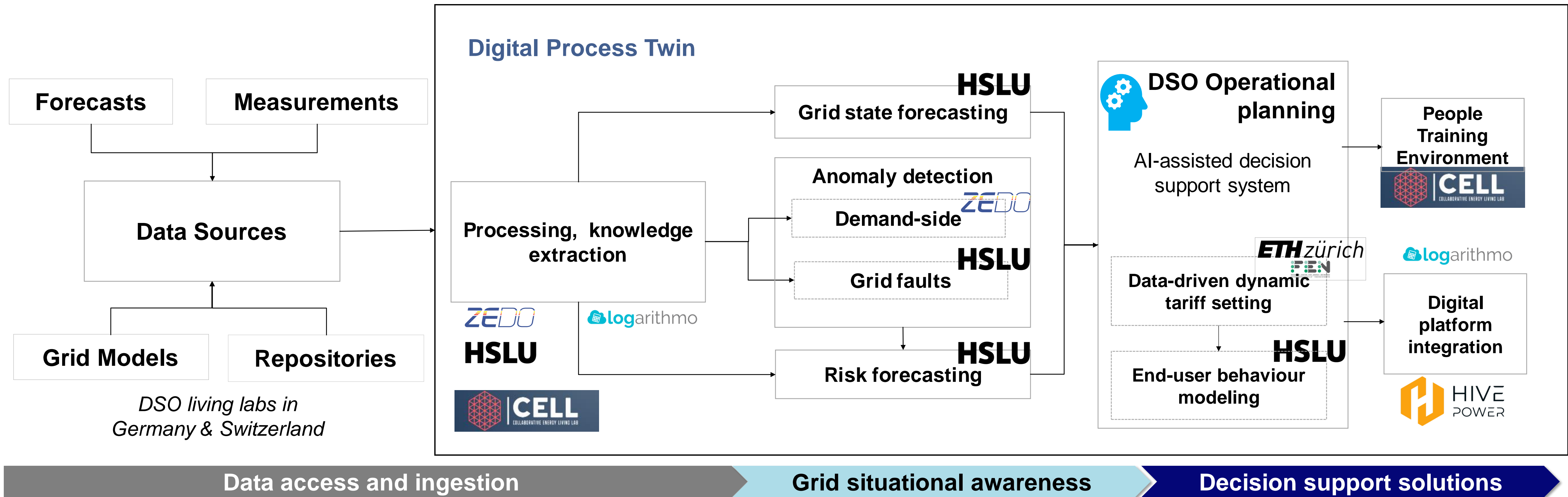

Laufende Arbeiten

Spannungsprognose

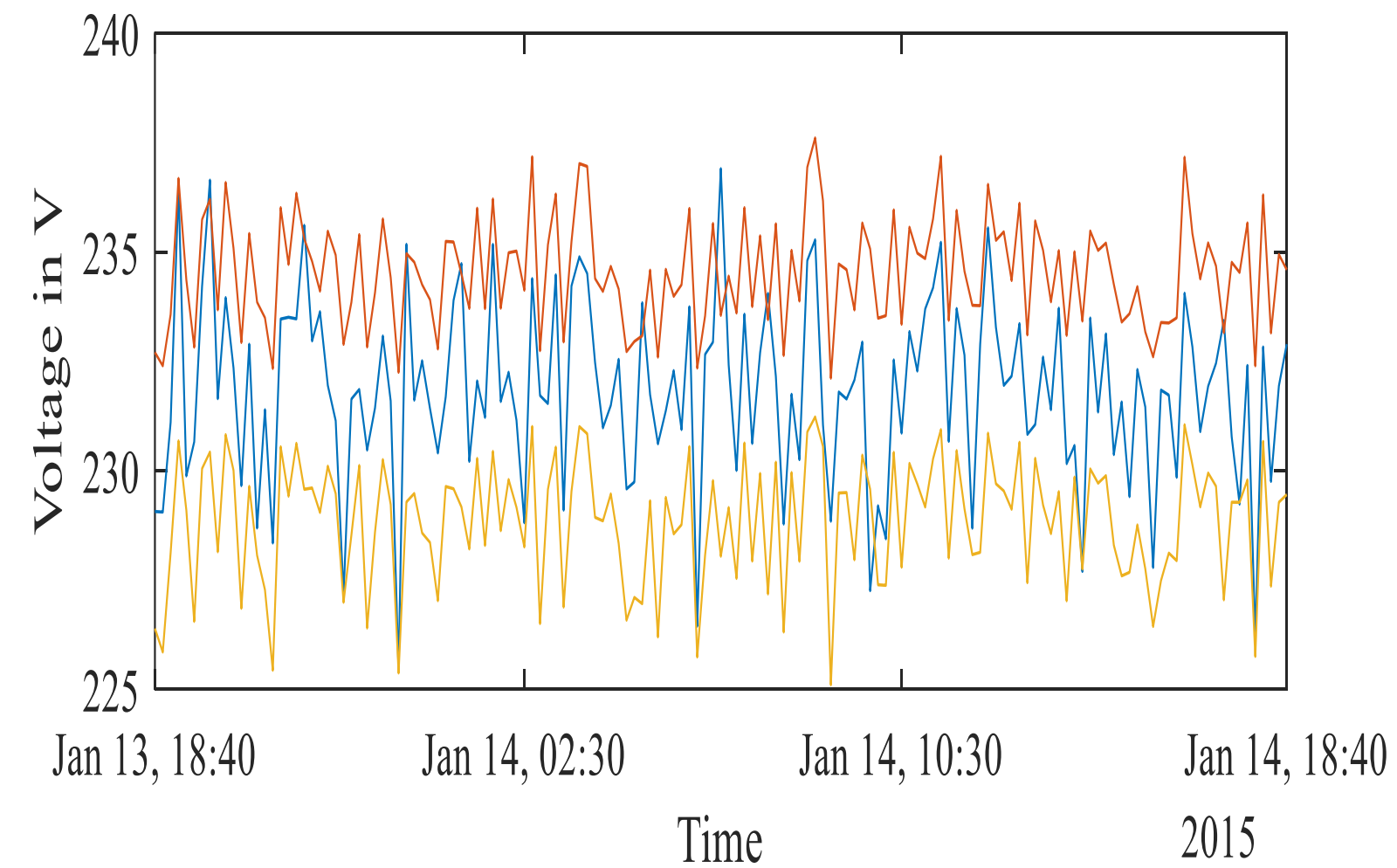

Lastprognose

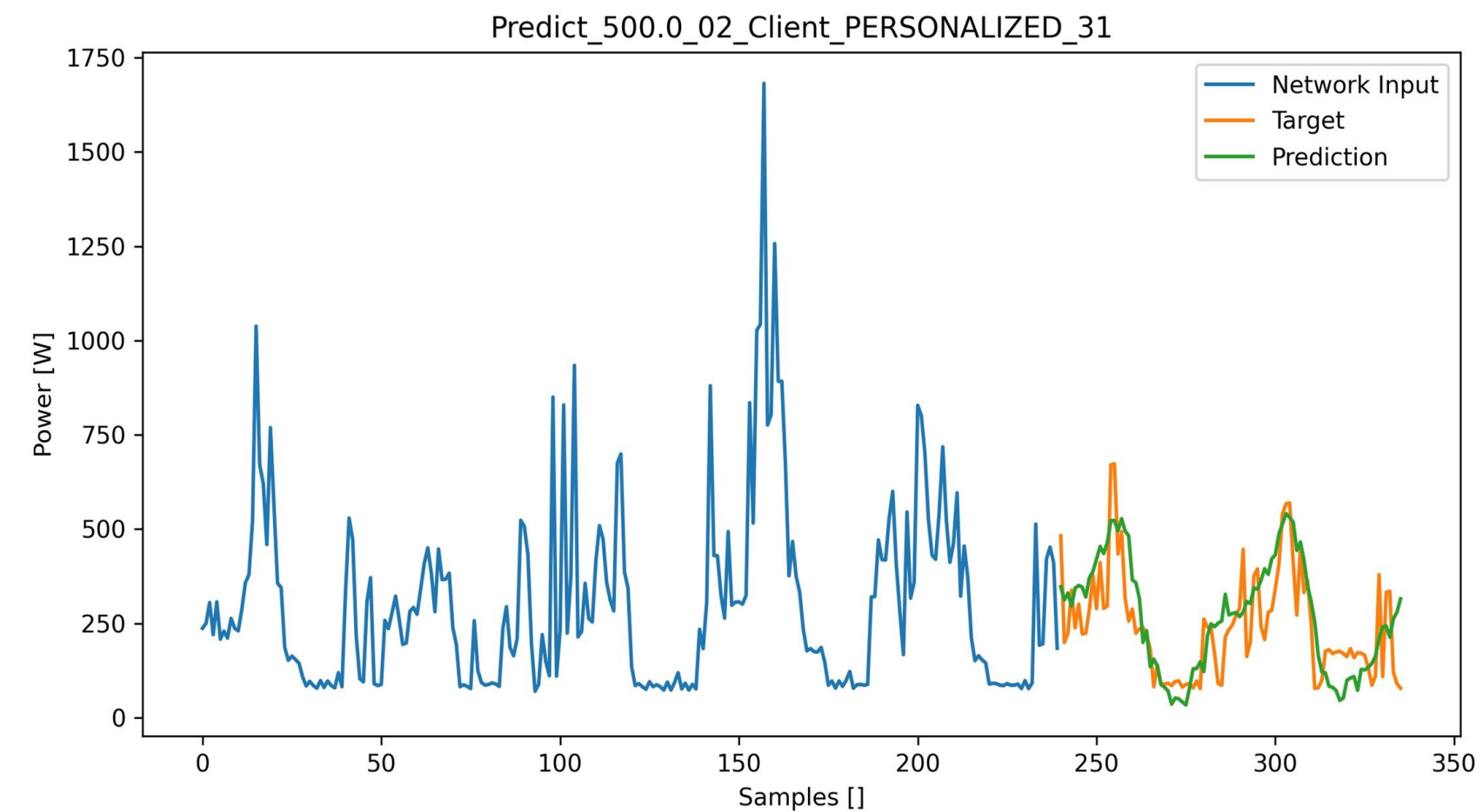

F. Widmer, S. Nowak, B. Bowler, P. Huber, A. Papaemmanouil, **Data-driven comparison of federated learning and model personalization for electric load forecasting**, Energy and AI, Volume 14, Elsevier, 2023

Fehlererkennung

Model	Fault detection			
	Radial		Mesh	
	Accuracy	Error	Accuracy	Error
Linear regression	0.019	0.16	0.016	0.165
Logistic regression	0.788	0.21	0.788	0.212
Multilayer perceptron	0.827	0.17	0.867	0.133
Naive bayes	0.812	0.19	0.823	0.177
Decision-tree	0.901	0.10	0.921	0.079
k-nearest neighbors	0.944	0.06	0.939	0.061
Random forest	0.825	0.18	0.844	0.157
Gradient boosting	0.947	0.05	0.949	0.051

* M. Hojabri, S. Nowak, A. Papaemmanouil, **“ML-Based Intermittent Fault Detection, Classification, and Branch Identification in a Distribution Network”**, MDPI Energies, 2023

Laufende Arbeiten

Anomalienerkennung

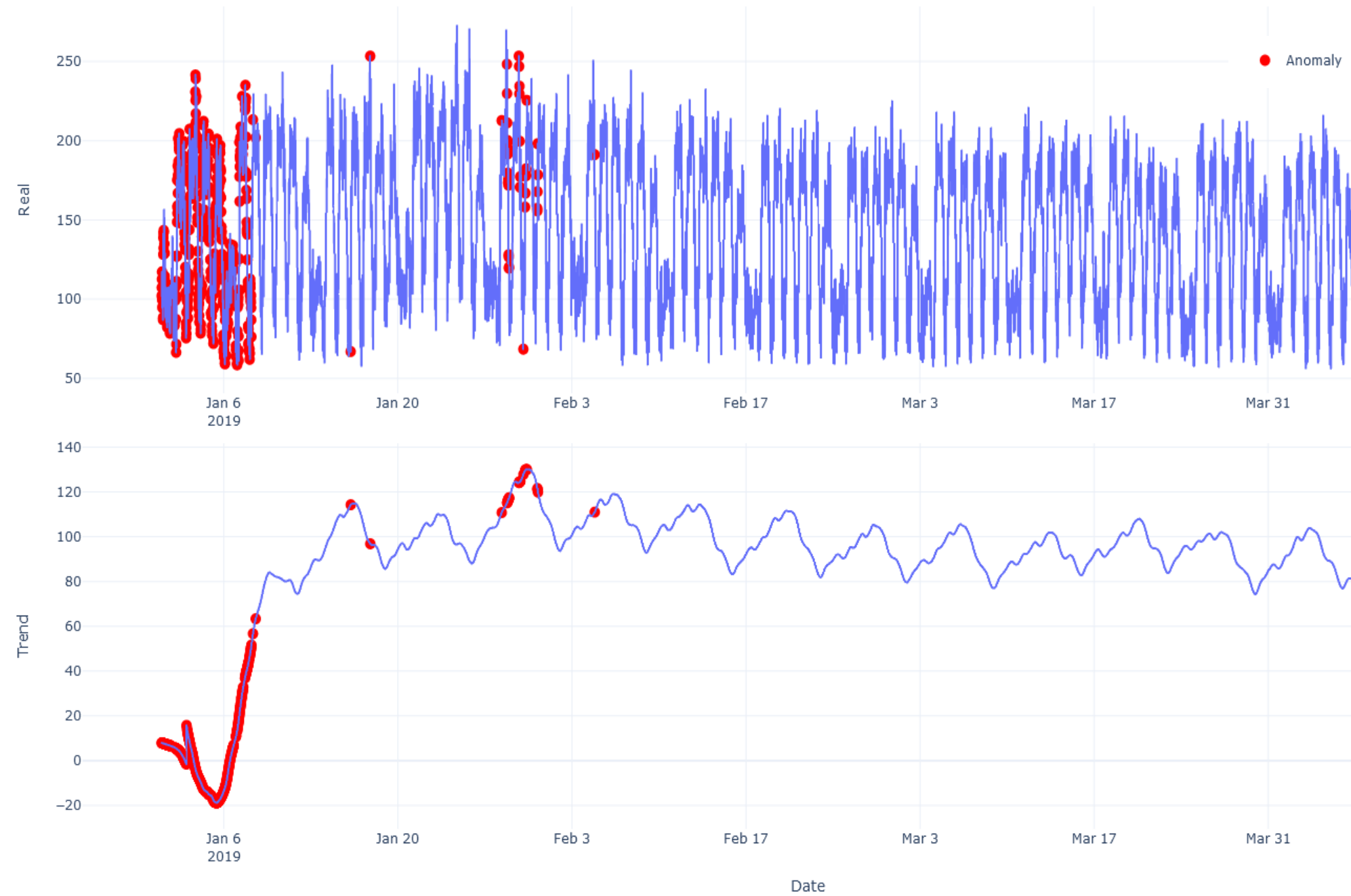

Dynamischer Tarif

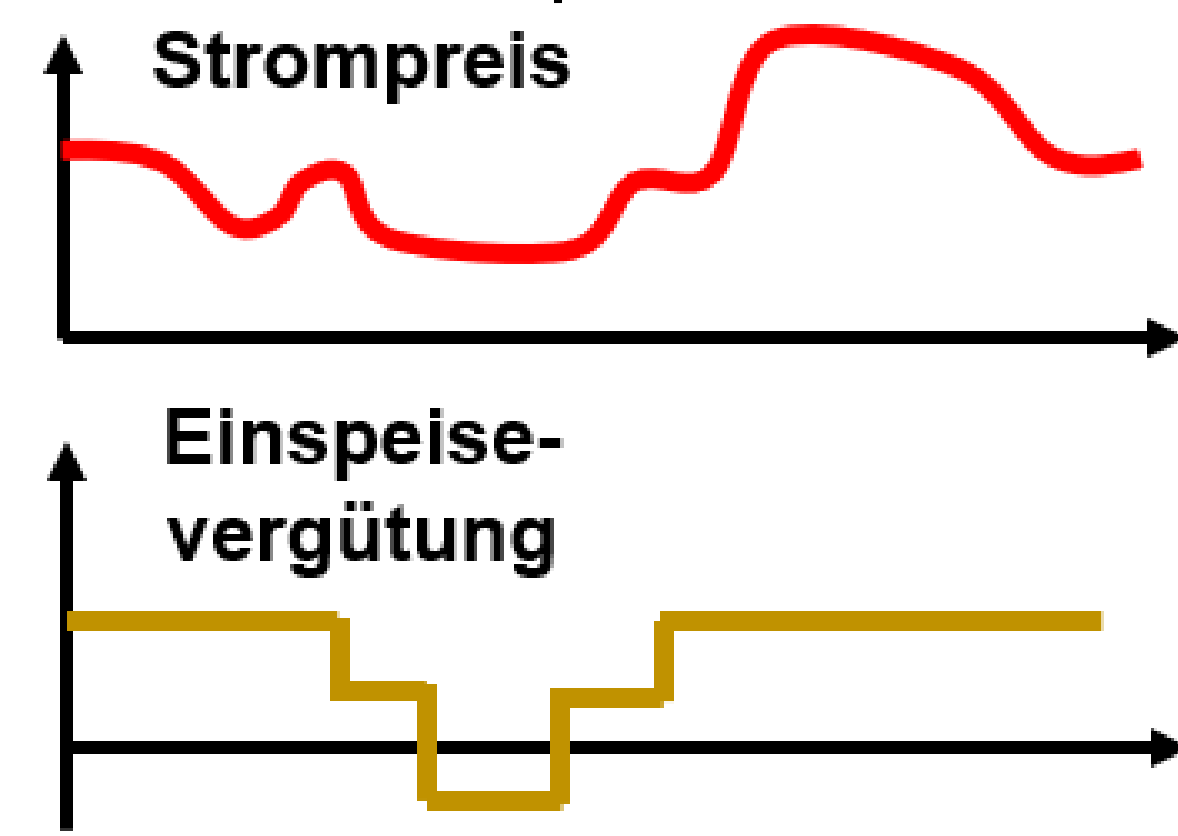
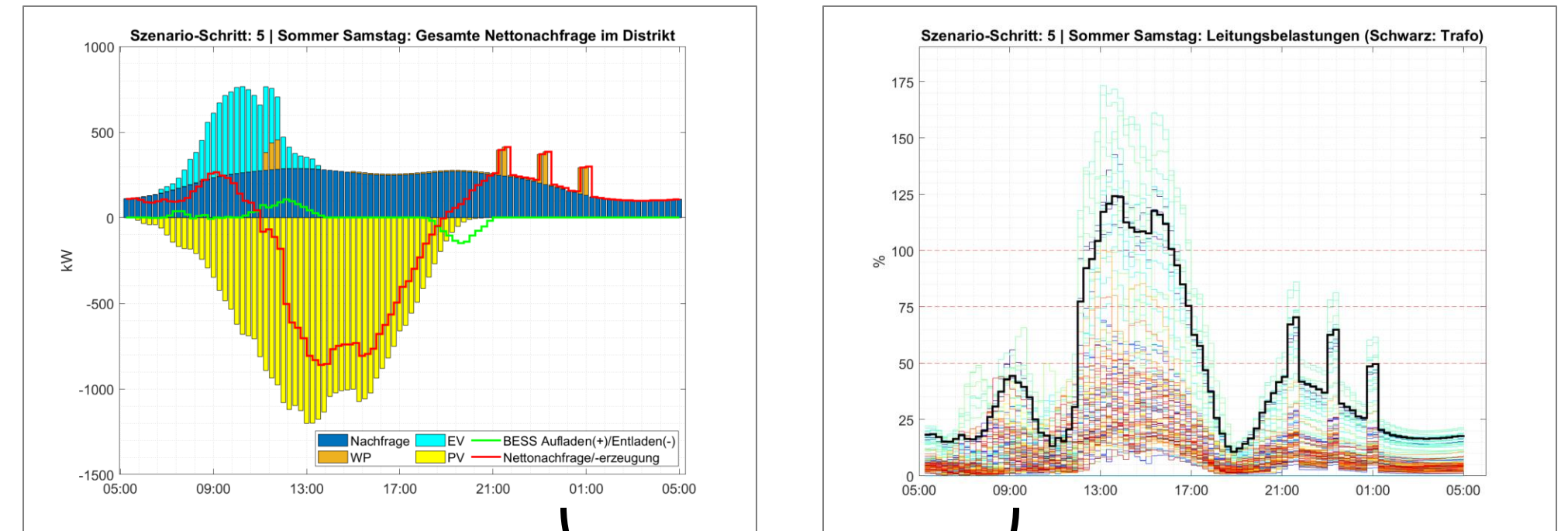

Wie geht es weiter?

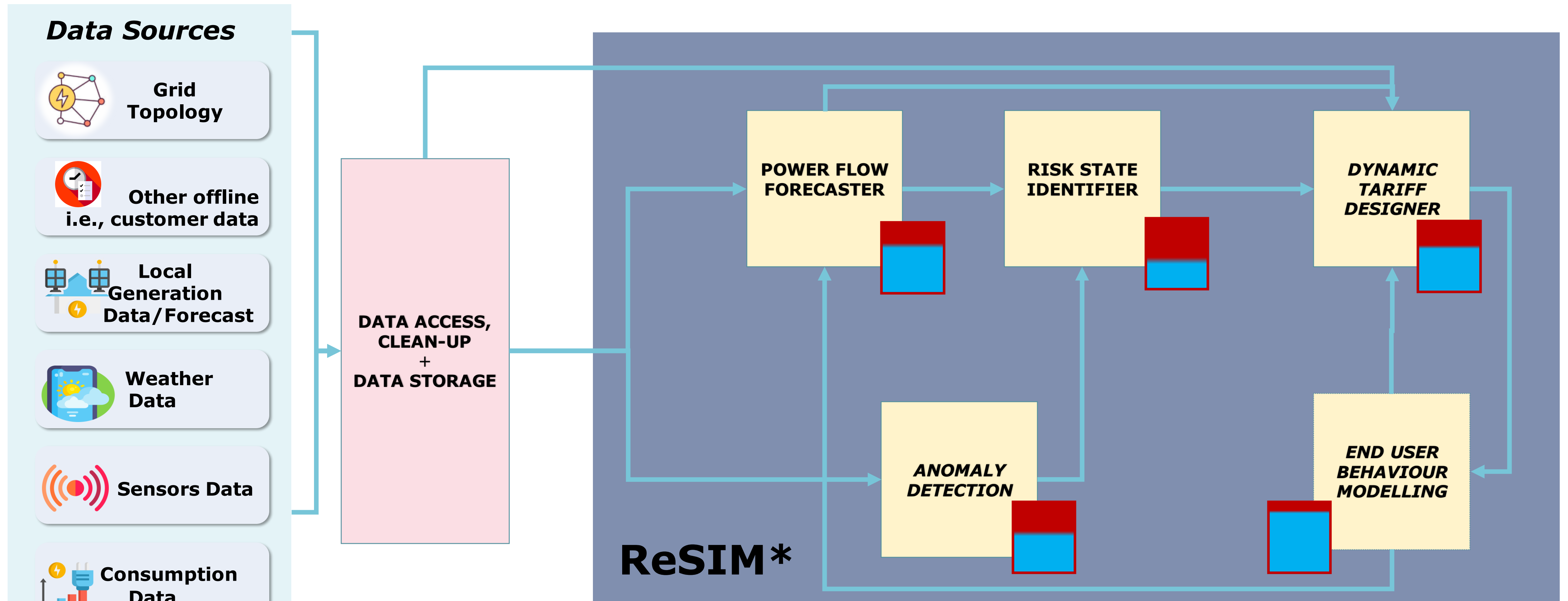
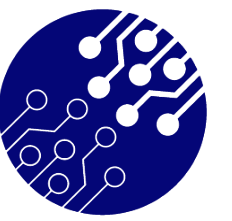
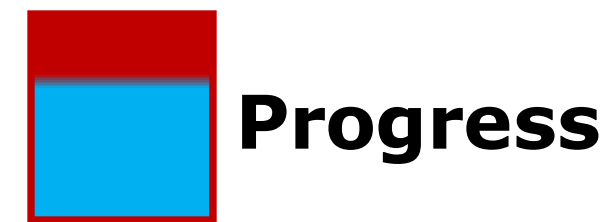

* ReSIM, a multi-energy system Simulation Framework developed by ETHZ-FEN in Python, within the scope of the ReMaP project, funded by SFOE, <https://remap.ch>



Chancen und Opportunitäten

- ❖ Steigerung der Netztransparenz/Beobachtbarkeit
- ❖ Ermöglichung einer hohen Durchdringung von dezentrale Energieerzeugungsanlage (DEA)
- ❖ Reduzierung der Energiekosten (durch faire Preisgestaltung) durch Vermeidung von Investitionen in die Infrastruktur
- ❖ Erhöhter Zugang von Prosumern zum Energiemarkt sowie Kapitalisierung von DEA-Investitionen
- ❖ Stärkung der Kundenbefähigung
- ❖ Erhöhte Unabhängigkeit der Gesellschaft von importierten Energiequellen

Vielen Dank für die
Aufmerksamkeit!

Hochschule Luzern
Technik & Architektur
Institut für Elektrotechnik IET
Prof. Dr. Antonios Papaemmanouil
Leiter Institut für Elektrotechnik

T direkt +41 41 349 30 90
antonios.papaemmanouil@hslu.ch



<https://aisoproject.com>

