

Safety & Waste Disposal Manual

for students and trainees at ETH Zürich

EMERGENCY Tel: 888 (from outside lines 044 342 11 88)

Department SHE
Safety, Health and Environment

www.sicherheit.ethz.ch,
safety@su.ethz.ch

HCH
Hochstrasse 60
8092 Zürich

Tel: (044 63) 2 65 33

Preface

Accidents always mean pain for the victim and lead to loss for the victim as well as the enterprise.

The following Safety and Waste Disposal Manual should give you instructions for the appropriate precautionary measures to be considered in individual fields. The thematically arranged chapters allow rapid access to the most important information. With the following handbook, we would like to place you in a position of finishing your studies at the ETHZ accident-free. In your working future, the manual offers you basic information about safety that will allow you to work safety-conscious as an employee or supervisor.

We wish you accident-free studies here at ETH Zürich.

Dept. of Safety, Health and Environment

Publisher:

**Federal Institute of Technology (ETH)
ETH Immobilien
Dept. of Safety, Health and Environment
ETH-Main Campus / HCH
8092 Zurich**

**8. Edition: July 2005
© Dept. of SHE**

HELLO!

I AM YOUR SAFETY AND WASTE DISPOSAL MANUAL



How I should be used:

- Chapters 1 and 2 deal with the fundamentals of basic safety precautions
- Chapters 3 to 10 contain appropriate instructions for specific practical courses
- I also serve as an all-around reference manual

Concerning safety:

In 2001, a total of 758 accidents (non-work related & work related accidents) were reported to SUVA by employees of ETH Zürich (ETHZ), among them 44 work related accidents and 182 non-work related with more than 3 days inability to work.

Also in 2001, 10 cutting injuries und 2 eye injuries through chemical splashes were reported by students to the Department of Safety. Since most students are privately insured against accidents and do not report in, the total number of accidents may lie even higher.

Therefore, I would like to help you to better recognize dangers, which you are exposed to during your practical work in laboratories or workshops in order to avoid accidents.

I don't want to scare you nor patronize you!

I would like to prevent either you or other students or employees of ETHZ against unnecessarily endangering yourselves. I will supply information at your disposal to better recognize dangers, which you can meet with the necessary precautionary measures so that you can avoid accidents. Therefore, you can work more securely and also independently if you have a look at the appropriate chapters before beginning your practical work!

Well then, there's nothing else to do but start!

In Chapter 1, I will inform you about legal regulations and generally about the possibilities for your personal safety protection. You can find the most important first aid measures and the locations of the first aid stations (just in case something goes wrong) in Chapter 2. You can inform yourself about the correct behavior in the handling of various sources and technical devices in case of accidents in Chapter 3 to 10.

After reading this, you will be prepared for your practical courses and your diploma or Ph.D. work and nothing (almost?) can happen to you!

Concerning waste disposal:

In 2001, ETHZ produced approximately 250 tons of waste that needed special disposal, including around 50,000 liters organic solutions, 4,350 liters acidic metal salt solutions, 2,570 kilos inorganic lab chemicals and 39,500 kilos glass.

Just as you sort glass, paper, metal and special wastes (batteries, medications, etc.) from the other wastes at home, you can contribute to environmental protection by also doing the same here at ETHZ by following my advice on the disposal of wastes referred to in Chapters 3 to 10. It is actually just as easy as at your home and hopefully just as natural!

Well then, I hope that we will see each other often and that I can answer all your questions!

YOUR SAFETY AND WASTE DISPOSAL MANUAL

TABLE OF CONTENTS

1. GENERAL PRECAUTIONARY MEASURES	1
1.1 LEGAL GUIDELINES	1
1.2 POSSIBILITIES FOR PERSONAL PROTECTION	1
1.2.1 EYE PROTECTION	2
1.2.2 SKIN PROTECTION	2
1.2.3 PROTECTIVE CLOTHING	3
1.2.4 HEARING PROTECTION	3
1.2.5 RESPIRATORY PROTECTION	3
2. FIRST AID	5
2.1 RESCUE	7
2.2 ALERTING EMERGENCY PERSONNEL	7
2.3 EMERGENCY STATIONS	9
2.4 TREATMENT OF UNCONSCIOUS VICTIM	9
2.5 RESPIRATORY ARREST	9
2.6 CARDIAC/CIRCULATORY ARREST	10
2.7 BLEEDING WOUNDS	10
2.8 TRAUMATIC SHOCK	11
2.9 EYE INJURIES	12
2.10 BURNS	12
2.11 CAUSTIC BURNS	12
2.12 POISONINGS	13
3. WORKING WITH CHEMICALS	15
3.1 WORKING SAFELY WITH CHEMICALS	16
3.1.1 GENERAL CONDUCT	16
3.1.2 BEHAVIOR IN CASE OF ACCIDENTS	16
3.1.3 PERSONAL PROTECTIVE MEASURES	16
3.1.4 CHEMICALS	17
3.1.5 HANDLING OF GLASS AND GLASS EQUIPMENT	18
3.1.6 ELECTRICAL APPARATUS, HEATING SOURCES	19
3.1.7 GAS BOTTLES	19
3.1.8 FIRE PREVENTION	19
3.1.9 SOURCES	20
3.1.10 FUME HOOD	20
3.2 CHEMICAL REACTIONS UNDER INCREASED PRESSURE	21
3.2.1 CHEMICALS	21
3.2.2 APPARATUS	21
3.3 WORKING IN CLEAN ROOMS	23
3.3.1 GENERAL CONDUCT	23
3.3.2 HANDLING OF CHEMICALS	23
3.3.3 DEVICES	24
3.4 CHEMICAL LIST	25
3.4.1 EXPLANATION OF CHEMICAL LIST	28
3.5 DISPOSAL OF CHEMICALS	44
3.5.1 MAIN WASTE DISPOSAL STATION	44
3.5.2 ORGANIC CHEMICALS	46
3.5.3 INORGANIC CHEMICALS	47
3.5.4 SPILLED CHEMICALS	49

4. WORKING WITH ELECTRICITY	51
4.1 GENERAL CONDUCT	53
4.2 BEHAVIOR IN CASE OF ACCIDENTS	53
4.3 DISPOSAL CONSIDERATIONS	53
4.4 WORKING WITH HIGH VOLTAGE	54
4.4.1 GENERAL FACTS	54
4.4.2 EXPERIMENTAL SETUP	54
4.4.3 OPERATION	55
4.4.4 DISPOSAL CONSIDERATIONS	55
5. WORKING WITH RADIOACTIVE MATERIALS	57
5.1 GENERAL CONDUCT	58
5.1.1 GENERAL PRINCIPLES	58
5.1.2 WORK CLOTHING	59
5.1.3 WORKING PLACE	59
5.2 PROPERTIES OF IMPORTANT ISOTOPES	60
5.2.1 IODINE-125	60
5.2.2 CARBON-14	60
5.2.3 PHOSPHORUS-32	61
5.2.4 SULFUR-35	61
5.2.5 TRITIUM (HYDROGEN-3)	61
5.3 BEHAVIOR IN CASE OF ACCIDENTS	62
5.4 DISPOSAL CONSIDERATIONS	63
6. WORKING WITH STRONG MAGNETIC FIELDS	65
6.1 GENERAL CONDUCT	65
6.2 BEHAVIOR IN CASE OF ACCIDENTS	66
6.3 DISPOSAL CONSIDERATIONS	66
7. HANDLING OF COMPRESSED GAS BOTTLES AND GAS	67
7.1 GENERAL FACTS	67
7.1.1 RECEPTION OF GAS CYLINDERS	68
7.1.2 TRANSPORT	68
7.1.3 STORAGE	69
7.1.4 VALVES AND FITTINGS	69
7.1.5 AT THE PLACE OF USE	70
7.1.6 PLACING INTO OPERATION	70
7.1.7 PLACING OUT OF OPERATION	71
7.2 CHARACTERISTICS OF SELECTED GASES	71
7.2.1. ACETYLENE	72
7.2.2. AMMONIA	73
7.2.3. CARBON MONOXIDE	74
7.2.4. NATURAL GAS	75
7.2.5. OXYGEN	76
7.2.6. SULFUR HEXAFLOURIDE	77
7.2.7. HYDROGEN SULFIDE	78
7.2.8. NITROGEN	79
7.2.9. NITROGEN DIOXIDE	80
7.2.10. HYDROGEN	81
7.3 BEHAVIOR IN CASE OF ACCIDENTS	82
7.4 DISPOSAL CONSIDERATIONS	82

8.	WORKING WITH ORGANISMS	83
8.1	GENERAL CONDUCT	84
8.2	BEHAVIOR IN THE L2 LAB	85
8.3	BEHAVIOR IN ACCIDENTS AND CONTAMINATION (L2)	86
8.3.1	CONTAMINATION (L2)	86
8.3.2	ACCIDENTS	87
8.4	DISPOSAL CONSIDERATIONS	87
9.	WORKING WITH LASERS	89
9.1	GENERAL BEHAVIOR	91
9.2	BEHAVIOR IN CASE OF ACCIDENTS	92
10.	WORKING AT THE MACHINE SHOP	93
10.1	GENERAL CONDUCT	93
10.1.1	SHARP CUTTING TOOLS	93
10.1.2	COMPRESSED AIR	94
10.1.3	WELDING, BRAZING	94
10.1.4	MACHINES WITH ROTATING PARTS	95
10.2	BEHAVIOR IN CASE OF ACCIDENTS	96
10.3	DISPOSAL CONSIDERATIONS	96

1. GENERAL PRECAUTIONARY MEASURES

1.1 Legal Guidelines

Students of ETHZ are subject to the regulations stated in the Protection from Accidents and Occupational Illnesses (Verordnung über die Verhütung von Unfällen und Berufskrankheiten - VUV), issued in 1983, which is based on the Federal Regulations Concerning Accident Insurance (Bundesgesetz über die Unfallversicherung - UVG). Relevant for you is Article 11, which describes the responsibilities of the employee. This article requires that you comply with the generally recognized safety rules described in this manual, use personal protective equipment (e.g., eye protectors) consistently and immediately report any laboratory safety equipment that is missing or improperly working. Article 44 requires you to take the necessary precautions in handling hazardous materials. Articles 3 to 10, on the other hand, require ETHZ, as an employer, to provide a safe environment, for example, by providing personal protective equipment and informing you of any possible dangers. The Department of Environmental Health and Safety at the ETHZ (Abteilung Sicherheit und Umweltschutz, Abt. S+U) is responsible for these tasks.

When working with sources and devices, it is necessary to comply with certain laws such as the poison statutes, the material regulations or the radiation protection ordinances. These laws also state the guidelines for the correct disposal of wastes. It is highly recommended that diploma and Ph.D. students, who will be working independently in a laboratory or workshop, be well versed on the regulations imposed on their field of activity. This avoids unpleasant surprises in the case of accidents (i.e. arrests), **since each person is responsible for learning his/her proper course of action.**

1.2 Possibilities for Personal Protection

Accidents can be avoided! Information will be provided in this manual. In each case, the "**3 Step Principle**" will be followed:

Step 1: ELIMINATION OF DANGER
(search for alternatives)



Step 2: CONTAINMENT OF DANGER
(safety precautions)

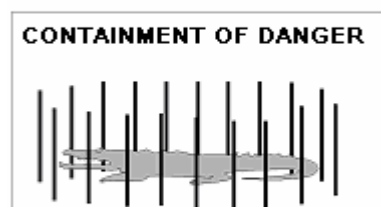

Step 3: PROTECTION OF PEOPLE
(behavioral guidelines)



Protective effect decreases, particularly concerning reliability, from top to bottom. Only as last resort, if elimination or containment of danger is not possible, your safety conscious behavior and use of special protective equipment, will be your source of protection. These possibilities for personal protection will be more thoroughly explained further on.

1.2.1 Eye Protection

Mechanical effect, heat, chemicals or energy emissions can hurt the eyes.

Experience has shown that at ETHZ, the handling of chemical materials, above all, and in more recent times, work with energy beams (lasers) can lead to eye injuries. In most cases, such injuries can be prevented by the use of suitable **safety glasses**. Safety glasses have relatively large, shatterproof lenses and an impact and heat resistant frame. When handling chemicals or lasers, it is important that safety conscious behavior, above all, is observed.

If you complete a chemistry practical course in the context of your studies, you will receive from ETHZ vision corrected safety glasses (see below). These glasses protect your eyes better than the usual correction safety glasses since they provide a side protection in addition to the safety lenses and frame already mentioned. If working with larger quantities of strongly corroding acids or caustic solutions, you should use closed eye goggles (see below) and carry a face shield.



Fig. 1.1: Safety glasses with protective lenses and side protection



Fig. 1.2: Closed eye goggles

You should **not wear contact lenses** when handling chemicals, since they can strengthen the effect of chemicals penetrating between lens and eyes and, in some cases, certain chemicals make the removal of the lenses difficult!

When operating lasers, special laser eye protectors will be provided which provide protection for the specific range of wavelengths of the laser.

1.2.2 Skin Protection

Mechanical effects, like heat, cold, chemicals, microorganisms or energy beams can damage the skin. At ETHZ, you can be exposed to all sources of danger. Skin protection, which consists, at least, of hand cream or latex gloves, must therefore be adapted to the respective sources of danger. Also here, safety conscious behavior must first be observed.

One of the most frequent mechanical injuries, the cut at the hands, can be prevented by the use of gloves while handling glass equipment and also, by correct cutting techniques. When handling hazardous materials, the thorough washing of the skin before and after the work in the laboratory is important.

1.2.3 Protective Clothing

Protective clothing, such as a laboratory coat, is important in order to protect the whole body or also the clothes against the disturbing or harmful effects of dirt and chemicals. In the case of contamination or fire, it should be rapidly and easily removed. In clean rooms, protective clothing is a necessity in order to prevent the contamination of the rooms from agents such as road dust, etc. Therefore, in clean rooms, lab coats are mandatory. In chemical practical courses and workshops, the use of a laboratory coat is either mandatory or recommended.

1.2.4 Hearing Protection

At ETHZ, ear protectors are sometimes necessary, particularly in workshops or within the range of machine rooms. Remember that hearing damage is, in each case, irreversible!

There are various earphones or plugs, which provide protection for the hearing. It is important that they are consistently worn. Otherwise their protective effect becomes strongly decreased. For example, someone who works with a noise of 100 dB (A) and wears no ear protection during 10 % of his working time, is still exposed to a (harmful) noise pollution of 90 dB (A). The SUVA has classified a constant sound pressure level (L_{eq}) starting at 88 dB (A) and lasting at least 8 hours per day as damaging to hearing (SBA NR. 147).

1.2.5 Respiratory Protection

The respiratory system and lungs can be damaged by dust, chemical gas or steam, and different types of gases. Inhalation of gas or steam can also be harmful to the central or peripheral nervous system or other organs such as liver or kidney.

Also here, safety conscious behavior stands as the cardinal rule for the prevention of accidents. Thus, chemical reactions which can develop harmful steams or gases, should be performed under the fume hood, with the ventilation switched on and the front shields closed whenever possible. Inform yourself, especially before starting a reaction, which substance could develop; some dangerous gases such as carbon monoxide are odorless!

With mechanical work you can, for example, moisten the workpieces, in order to prevent the creation of dust. If this is not possible, a ventilation source must be provided. The possibilities for respiratory protection are easy enough, from a simple dust respirator over half masks to full masks with the appropriate filter guards. If there is not enough oxygen supply available, this can be supplemented with the use of compressed air breathing masks.

References:

- Verordnung über die Verhütung von Unfällen und Berufskrankheiten (Verordnung über Unfallverhütung, VUV); 19. December 1983
- Schweizerische Blätter für Arbeitssicherheit (SBA), Nr. 12: Berufliche Lärmschwerhörigkeit; Schweizerische Unfallversicherungsgesellschaft (SUVA); Lucern; 1988
- SBA, Nr. 85: Der Augenschutz; SUVA; 11. Edition; Lucern; 1990
- SBA, Nr. 147: Der persönliche Gehörschutz; SUVA; 1. Edition; Lucern; 1988
- SBA, Nr. 122: Hautschutz; SUVA; 6. Edition; Lucern; 1992

Unfall – was tun? Accident – how to react?

**1. Verletzungsart >
Alarmieren
Kind of injury >
Call 'S.O.S.'**

**immer
888
always**



**Schwerer Unfall
Severe accident**

0-144



**Vergiftung
Poisoning**

0-145



**2. Nothilfe leisten (GABI,...)
First Aid (ABC,...)**



Alle Notfälle / All emergencies: 888

ETH Zürich, Abt. Sicherheit / safety@su.ethz.ch / www.sicherheit.ethz.ch

Feuer – was tun? Fire – how to react?

**1. Alarmieren
Call 'S.O.S.'**



**2. Personen retten
Rescue all people**



**3. Türen schliessen
Close all doors**



**4. Brand bekämpfen
Fight the fire**



Alle Notfälle / All emergencies: 888

ETH Zürich, Abt. Sicherheit / safety@su.ethz.ch / www.sicherheit.ethz.ch

2. FIRST AID

Each laboratory has a **first aid box** available for use. Familiarize yourself of its location before starting work. Used up materials will be replaced at any time by the Department of Safety + Environmental Protection (Abt. S+U - Abteilung Sicherheit und Umweltschutz –safety@su.ethz.ch).

2.1 Rescue

As an initial course of action, the victim should be removed from the source of danger and **immediate life-saving measures** should be taken!

Consider self-preservation as the cardinal rule in each case!

- Electrical accidents:	Turn off power source (turn off, unplug and remove fuse at main junction box). If this is not immediately possible, separate victim from charged area by using a non-conductive material (such as a wooden slat) or pull away victim from the site by grabbing the clothes. You should insulate yourself by standing on a grounded base (such as a dry board, thick newspaper) making sure to touch nothing (wall, other person etc.)! Continue if necessary to 2.4 or 2.6.
- Accidents with gas or poisonous steam:	Rescue only with the use of respiratory protection. Move victim immediately to fresh air. Continue further, if necessary to 2.5.
- Accidents with fire:	Stop burning victim and extinguish fire (emergency shower, dousing blanket, and towels, especially synthetic materials, never with the hand!), further to 2.9.
- Caustic burns:	Immediately remove contaminated clothing, further to 2.10.

Observe the following:

- Examine breathing and pulse (see 2.5 and 2.6).
- Do not leave victim to cool (cover with blanket).
- Clear obstacles blocking air passage.
- Free victim of restraining clothes.

2.2 Alerting Emergency Personnel

Report accident immediately to a supervisor. If necessarily, call the appropriate **emergency number** (possible from nearly all internal phones):

Tel. 888 (internal emergency no.)	Alerts the emergency service at the Dept of Safety + Environmental Protection day and night. Contact to report damage to property and serious injuries!
---	--

fire dept.	0-118
ambulance	0-144
police	0-117

The medical ambulance must be shown the way. In case of **fire**, refer to the **pamphlet, “Es brennt - Was tun?”**(It is burning – What should be done?).

2.3 Emergency Stations

In the case of minor injuries, the victim can visit the emergency station **accompanied by another person**. In case of eye injuries, go directly to the ophthalmic clinic!



2.4 Treatment of Unconscious Victim

In order to avoid possible asphyxiation from foreign bodies or the tongue falling to the rear of the mouth, the **unconscious victim** must be immediately **positioned onto his side** (see below). One should check whether **the breathing passage is free**. Foreign bodies must be immediately removed!



2.5 Respiratory Arrest

With respiratory arrest (no audible or visible air flow from nose or mouth perceived; no lifting and lowering of thorax), artificial respiration should be immediately administered:

Lay victim on his back (possibly sideways), while placing one hand on the forehead and the other hand under the chin, gently tipping the head backwards.



With the mouth opened wide, blow into the nose (one can place a handkerchief or the like in between). If the nose is clogged, blow into the victim's slightly opened mouth.



While taking a deep breathe, watch for the victim expelling air: lowering of thorax, the sound of breathing. Always wait for victim to exhale before blowing in again!



Perform the first 2 artificial respiration breaths quickly but deeply, then 12 to 15 times per minute (once every 4 to 5 seconds, waiting for air to be expelled between each breath!). Terminate artificial respiration only after the victim is again able to breathe independently or upon arrival of the medics!

2.6 Cardiac/Circulatory Arrest

If the following three symptoms are **all** present, begin immediately with CPR:

- **unconsciousness**
- **respiratory arrest**
- **no pulse (carotid artery)**

Preferably, two people should perform the CPR together (one person artificial respiration, the other heart massage).

1. One person begins immediately with the artificial respiration (see Chapter 2-5). Blow in 2 times, then check for self-respiration and pulse.
2. At the same time the other helper frees the torso of the victim (fastenings can lead to injuries) and looks for **the pressure point in order to give the heart massage (feel the breastbone, then 2 finger widths (with very narrow fingers 3) in the direction of the head)**.
3. If not breathing on his own or no pulse, alternate:
 - 15 abdominal thrusts (Apply approx. 3 to 5 cm of pressure to the breastbone!)
 - 2 artificial respiration directly after the last thrust, perform 4-5 cycles per minute
4. Check for respiration and pulse every 3 minutes. Continue until pulse and/or respiration begin again or medics arrive.

2.7 Bleeding Wounds

- | | |
|--------------------|--|
| - minor cuts: | allow to bleed, disinfect, and bandage |
| - major cuts: | if possible, staunch bleeding (see below), bandage, see physician |
| - puncture wounds: | are dangerous! If possible, pull out object; seek medical treatment in all cases. |
| - finger injuries: | remove rings immediately. If the injury is serious, seek medical treatment. |

Staunching of bleeding

- Suspend bleeding part as high as possible.
- Apply pressure with bandage:
form thick pad of cloth into a compress and apply pressure, tie down with dressing or necktie.

If bleeding does not stop:

- Wrap second layer of bandage over the first
- Apply additional direct pressure on the wound:
press artery toward heart over the underlying bones (see below). If necessary, by maximum bending at the hip, the thigh artery can also be squeezed.

a) on the upper arm



b) on the groin area



- In case direct pressure on the artery is not possible, a finger or the fist can be pressed directly into the wound.

To ensure staunching of bleeding:

- Bandage light bleeding (possibly brief finger pressure on the bandage).
- Use pressure dressing for strong bleeding (See above); if insufficient, position higher, keep still. Seek medical treatment.

With severe bleeding exists the possibility of traumatic shock! (See bottom).

2.8 Traumatic Shock

The following **symptoms** point to shock (not always all or at the same time):

- sweat on the forehead, extreme unrest
- pale, cold skin (esp. the extremities)
- pulse becomes faster, then weaker and finally, hardly detectable

If the victim exhibits these symptoms, **the bleeding must first be staunched**. In addition, the leg must be elevated in a supine position, loss of heat avoided, pulse and breathing controlled, and victim's sense of orientation observed. Seek medical treatment.

2.9 Eye Injuries

If **chemicals** come in contact with the eyes, they must be rinsed at least 10 to 15 minutes with the help of an eye bath or calmly flowing lukewarm water jet. A second person should keep the eyes of the victim open. If wearing contact lenses, immediately remove them.

Eyes must be rinsed carefully with long flushing after coming into contact with the following substances:

- hydrofluoric acid
- alkaline compounds (soda -, caustic potash solution, ammonia, amines, etc.)

Never try to neutralize penetrated substances with other chemicals!

Bring victim to the ophthalmic clinic only **after** flushing (refer to map, p.6).

If **foreign bodies** (e.g., glass fragments) penetrate into the eyes:

- the victim must be prevented from rubbing the eyes
- if necessary, flush eyes as described above.
- only loosely sitting foreign bodies may be removed, e.g., with the corner of a clean cloth, never with tweezers. **Never try to remove imbedded foreign bodies!**
- Transport victim to eye clinic in **lying position**.

2.10 Burns

After extinguishing fire, immediately remove clothing that does not stick to the skin. Cool burned area of skin with cold water until pain is relieved (20 to 30 minutes). Then afterwards, seek further medical treatment!

- Skin only reddened: Repeat cooling of area if pain returns; if large area is affected, seek medical treatment.
- Blistering: Do not use ointments! Do not perforate blisters. Seek medical treatment.

2.11 Caustic Burns

Immediately take off contaminated clothes; do not use anymore. Rinse affected area with large quantities of water. Remove organic substances with soap and water, never with solvents (alcohol etc.).

Otherwise, treat like a burn injury (refer to 2.9).

If there is danger of percutaneous poisoning, refer to 2.12.

2.12 Poisonings

In case of poisoning, it is critical for correct medical treatment that a sample of the poison (substance, gas sample, vomit, etc.) is brought along!

Oral Poisonings

In principle, oral poisonings can be ruled out with the use of bulbs, pipetteboys, etc.! Treatment of oral poisonings is differentiated according to its 2 substance classes:

1. **Standard poisons** (metal salts, organic substances, insecticide, etc.) and **water-insoluble solvents** (benzene, toluene, petroleum, ether, etc.). Induce vomiting as soon as possible, either with mechanical irritation of the throat wall or by the ingestion of lukewarm salt water (approx. 3 heaping teaspoons of salt per glass). Repeat until vomiting is cleared. Subsequently, seek medical treatment.
2. **Corrosive liquids** (acids, caustic solutions, etc.)
Immediately drink as much water as possible, do not induce vomiting, seek medical assistance.

Important:

- **Do not give anything to drink to unconscious persons; they could suffocate!**
- **Never attempt to neutralize ingested chemical with another!**

Percutaneous poisoning

Immediately release affected skin area and wash well with soap and water, seek medical help.

Gas poisoning

After rescuing victim from danger zone, move him/her to fresh air, calm victim and observe breathing, resuscitating if necessary (see 2.5) Deliver to hospital with ambulance.

References:

- Bundesverband der Unfallversicherungsträger der öffentlichen Hand e.V. (BAGUV); Abteilung Unfallverhütung und Arbeitsmedizin (Hrsg.): *Sicheres Arbeiten in chemischen Laboratorien; Einführung für Studenten*; Chapter 11; 2. Edition; Germany, 1988
- Kühn; Birett: *Merkblätter Gefährliche Arbeitsstoffe*; Band 5 und 6, ecomed; Landsberg/Lech; Looseleaf collection starting 1975
- Roth; Dauderer: *Giftliste; Giftige, gesundheitsschädliche, reizende und krebserzeugende Stoffe*; Volume 1; Part I (Notfallhilfe); 5. Edition; ecomed; Landsberg/Lech; 1981

3. WORKING WITH CHEMICALS

This chapter helps to prepare you in the handling of chemicals, to behave safely and recognize sources of danger and, therefore, avoid accidents (often caused by ignorance or wrong behavior).

The following example shows what can develop from an allegedly harmless situation: A student in a microbiology laboratory was working with an inoculation needle to inoculate microorganisms in a growth medium. In order to disinfect the needle, it was dipped between work procedures into a bowl containing 70% alcohol and flamed afterwards with a Bunsen burner. At some point, he placed the bowl too close to the flame of the Bunsen burner, and the alcohol caught on fire. The student let the bowl fall. Thus, the alcohol bottle in the hood also caught fire. The following photo of the accident site shows the outcome. Fortunately, the student was not hurt.



Fig. 3.1: Result of a laboratory fire due to inappropriate handling of flammable chemicals

In Section 3.1, you will receive guidelines for general conduct in the chemistry laboratory. Two chapters discuss reactions under high pressure and working in clean rooms.

Section 3.4 contains information about potential dangers and toxicological properties of selected chemicals as well as instructions for first aid.

Instructions for the disposal of chemicals will be discussed in Section 3.5.

3.1 Working Safely with Chemicals

3.1.1 General Conduct

- **Never work alone** in the laboratory.
- Due to the danger of fire and oral poisonings, **smoking is forbidden everywhere** in the chemistry laboratory.
- **Food and drinks** may not be stored or consumed in the laboratory.

Food that is used for experimental purposes in the laboratory should be marked with the following label:



- **Visitors** are only allowed admission in the laboratory with the express permission of the lab supervisor. Equip them every time with **visitor safety glasses** for their own safety.
- Close the windows and ventilations in the evenings, turn off certain sources (water, gas, electricity, etc.), put away the stools, turn off scales, if necessary, clean and cover.

3.1.2 Behavior in Case of Accidents

Refer to Chapter 2.

3.1.3 Personal Protective Measures

- Always wear **safety glasses** in the lab.
- If possible, avoid wearing contact lenses.
- Never work without a **laboratory coat**.
- When working with large quantities of corrosive liquids, always wear **closed eye goggles** and use a face shield.
- Use **gloves** when working with corrosive or toxic substances.

3.1.4 Chemicals

→ Mark each chemical bottle with a **label** that indicates at least the following information:

- name of the substance
- molecular formula
- date of filling
- name of the responsible person

Write only with water-resistant, black felt-tip pens or ballpoint pens, as other pens become illegible after a short time. At the chemical counter, labels are available for indicating the poison class.

- The purchase of poisons of class 1 and 2 for private purposes as well as any procurement of chemicals for a third party is forbidden.
- One needs to submit a **poison form** signed by the lab supervisor to purchase poisons of classes 1 and 2.
- Store only the smallest possible amount of chemicals in the laboratory.
- **Inform yourself** carefully before you begin an experiment, about the physical properties, the toxic and the (possibly dangerous) reaction properties of the appropriate chemicals. Also refer to Chapter 3.4 and Chapter 7.2.
- Chemical solutions should **never be pipetted with the mouth**. Always use pipetting aids (danger of oral poisoning!).
- For experiments, only use undamaged, **clean containers**. Never use containers that contain leftover chemicals.
- **Food containers** should **not** be used for the storage of chemicals.
- Use the smallest possible quantities for experiments.
- Place chemical containers, bottles, and devices **always as far back as possible** on the work surface (danger of falling off when knocked against).
- When heating materials in an open container, point the opening away from people.
- Use **boiling stones** when heating substances and make sure that the stones are added when the solution is **far** below the boiling point. Otherwise the liquid could suddenly cook over and spray all over (boiling retardation).
- Always immediately remove spilled chemicals, water puddles from the ground (danger of injuries).
- Use caution when **diluting concentrated acids** with water and when preparing solutions consisting of **solid alkali hydroxides** (e.g., KOH, NaOH). Always add acid or base into water while stirring, never in reverse (heat development!).

→ Solvents:

- Reduce the **stored supplies** to a minimum (fire risk). At the workbench and in the fume hood, use bottles that contain a maximum amount of 500 ml.
- Solvents of the **ether group** (R1-O-R2, e.g., CH₃-O-CH₃) and many hydrocarbons (e.g., butene C₄H₈) form highly explosive peroxides after long standing. Before each handling, control the peroxide content with the Mercloquant peroxide test! If it is higher than 0.01% (= 100 ppm, indicated as H₂O₂), the peroxides must be eliminated. Control periodically every 3 months. Do not open bottle if you observe unusual viscosity or crystallization! Inform the lab supervisor.
- When distilling peroxide-forming compounds, leave a small amount in the flask, never evaporate everything! Store distillates protected from light and if possible, with an inhibitor.
- Refer to **Disposal of Chemicals, Chapter 3.5**.

3.1.5 Handling of Glass and Glass Equipment

- Be careful when working with glass and glass equipment, in particular, when e.g., introducing glass tubes into rubber hoses. **Protect your hands** (use gloves). Puncture wounds due to broken off glass tubes are dangerous!
- **Thin-walled glass containers**, especially measuring and Erlenmeyer flasks, should **not be evacuated**. Vacuum desiccators should be covered with parafilm. They should not be transported in an evacuated condition.
- **Thick-walled vacuum flasks** should not be heated (suitable for evacuation).
- When transporting **large glass flasks**, never hold by the neck and not at all by the plug. Always **hold at the base** (danger of breaking). They may only be stored at the lower shelf.
- Never fill glass containers over 90 percent of filling capacity. To avoid the occurrence of stuck glass plugs, it is advisable to use **screw-on caps** if possible
- Do not force open **jammed glass plugs**. Rather, loosen by tapping it lightly with a wooden stick or slightly warming the outside (at the same time, if possible, cooling the inside).
- Dispose **glass waste**, after cleaning with the appropriate solvent, into their particularly intended container. Never dispose of them in the normal waste container (danger of injury to cleaning staff!).

3.1.6 Electrical Apparatus, Heating Sources

- Electrical apparatus may **not stand within the range of splashing water**.
- Keep them always **clean and free of corrosive substances**. This applies in particular, to balances. After use, first pull out plug and carefully clean afterwards.
- **Immediately report defective devices** including **defective or corroded cables and plugs** to the lab supervisor for repairs. Do not try to repair damages yourself (insulating tape, etc.)!
- In laboratory places equipped with **current fault switches**, do not turn off power by flipping the switches (excessive wear of the current fault switch).
- Use **open flames** as a heating source only if there are no other possible options.
- Make sure before using the **Bunsen burner** that no flammable materials are in the proximity of the flame. In principle, work in organic laboratories should be done under the fume hood.
- Do not use **water baths** to warm up containers with substances that strongly react with water (alkali metals, metal hydrides, organo-metalic compounds).

3.1.7 Gas Bottles

Refer to Chapter 7.

3.1.8 Fire Prevention

- Inform yourself before beginning work at a laboratory about the locations and the proper uses of the **emergency showers** and the **fire extinguishing equipment** as well as the **escape routes**.
- Limit the quantity of the **combustible liquids** kept at the laboratory to a minimum (see example pg.10) and keep it separate from strong oxidizing agents.
- For the storage of **flammable liquids that need to be stored cool**, use refrigerators reserved only for this purpose and are labeled as follows (see right).



In addition, consider the instructions of the lab supervisor, the notices, and the pamphlet, "**Es brennt - Was tun?**" ("It is burning – What should be done?") at the beginning of Chapter 2.

3.1.9 Sources

- Turn on the gas main valve only after you are sure that certain devices have been turned off.
- In the evening, **turn off gas, water, electricity, compressed air, and vacuum, as well as the hood ventilation.**
- **Evening experiments** may only be performed with the permission of the supervisor, whereby certain hoses should be secured with clamps and a **night panel** (see right) posted.

ETH Zürich	Sicherheitsdienst
Nachttafel	
Anlage bitte laufen lassen	
Für diese Apparatur ist verantwortlich:	
Name: _____	Vorname: _____
Labor: _____	Platz: _____
Tel. Labor: _____	Tel. Privat: _____
Wie erreichbar, wenn kein Privat-Telefon ?	
Reaktion: _____	
Lösungsmittel: _____	
Siedepunkt: _____	Badtemperatur: _____
Start: _____	Ende: _____
An dieser Apparatur sind folgende Medien angeschlossen:	

Sämtliche Schlauchverbindungen sind mit Briden gesichert! Empfehlungswert: Schlaucholiven mit Restriktion verwenden!	
Visum Assistent: _____	Datum: _____
Unterschrift: _____	
Notfallanweisungen s. Rückseite	

3.1.10 Fume Hood

- All work in which poisonous, flammable or otherwise dangerous or foul-smelling gas, steam, or aerosols could develop or escape should be performed under the fume hood.
- The **use of the fume hood** is, nevertheless, **not a free pass** for release of any amount of substances and chemicals. Toxic and corrosive gas and steam, as mentioned in the middle of references written about devices, should be absorbed at its place and position. This prevents disturbance of the environment and costly damage to the ventilation system.
- **Close the front sash** of the fume hood whenever possible.
- Equipment should be placed **as far back as possible**, against the back wall of the hood.
- Fume hoods equipped with switches to regulate ventilation should, for environmental reasons, only be set at the highest setting when in use. Otherwise, precious heat would unnecessarily escape.

3.2 Chemical Reactions under Increased Pressure

Certain reactions must be performed under increased pressure in order to e.g., raise the solubility of gas in liquid. The increased pressure brings along certain additional risks that require special security precautions.

3.2.1 Chemicals

→ **Extra precaution** is necessary with the following substances:

- oxygen and nitric oxide (danger of explosion)
- ethylene oxide (danger of explosion)
- nitro compounds (danger of explosive decomposition)
- hydrogen (danger of explosion)
- acetylene, ammonia, hydrazine (form explosive compounds with copper)
- halogen (corrosion of steel)
- strong acids or alkaline media (corrosion)

Moreover, many gases are **toxic**. Inform yourself before the start of a reaction exactly about the reaction properties and the toxicity of the chemicals! Also refer to Chapter 3.4 and Chapter 7.2.

3.2.2 Apparatus

- For reactions under increased pressure, use only suitable **devices and containers meant** for this purpose.
- Equipment may only be constructed at **places suitable** for this purpose (i.e. high-pressure laboratory).
- When **introducing gas into liquids**, a device must be constructed that prevents the return of the fluids into the system or the collection vessel (safety flask e.g., plunger).
- Containers and devices, which are placed under great pressure or heated in closed condition, must be equipped, as a rule, with a **manometer** (red mark at maximum pressure) and a **pressure valve** (safety valve and explosion shield). Also consider the developing gas that forms during the reaction.
- If the device is to be heated or cooled, one should take into consideration the **thermal pressures** that develop.
- Test that the device is **not leaky** before the reaction.
- If experiments are performed with **flammable** gases and fluids that develop flammable vapors, the air present in the device must first be evacuated before the start of the reaction.
- Make sure that at the start of the reaction that **no solvent containers** are standing around the area.

- If there is danger of exceeding the permissible running temperature or pressure, the reaction should be immediately interrupted (turn off heat, emergency cooling).
- The device may be opened after **pressure equilibration** with the atmosphere has been established. Make sure that no dangerous materials escape into the environment.

References:

- Bundesverband der Unfallversicherungsträger der öffentlichen Hand e.V. (BAGUV); Abteilung Unfallverhütung und Arbeitsmedizin (Hrsg.): Sicheres Arbeiten in chemischen Laboratorien; Einführung für Studenten; 2. Edition; Germany, 1988
- Petrozzi, S.: Richtlinien für Sicherheit und Umweltschutz im Hochdrucklabor; ETH Zürich; Zürich; 1994

3.3 Working in Clean Rooms

Etching technology is used at ETHZ in micro-mechanics, micro- and quantum electronics and high frequency technology for the production of microscopic tools or electronic components. Because of their slight size, they are not mechanically produced but rather etched from raw materials. For this purpose, strong acids and bases are utilized. In order to protect the work pieces from dust and other pollutants, the work is performed in clean rooms. The following are instructions that you must follow out of security reasons and on grounds of ensuring quality if you are to perform etching in the clean room.

3.3.1 General Conduct

- Clean rooms may only be entered through the entryway and only in full **clean room gear** (lab coat, lab shoes or overshoes, hood). For visitors, there are disposable overalls available for use.
- Etching may be performed only after **instruction** from a responsible person. Use only machines which you have been trained to use.
- **Never** work **alone** in the clean room.
- Always wear **safety glasses**. When handling large amounts of acid or bases use a face shield and special gloves.
- Handle the mask holder and other things that have come into contact with the work pieces only with gloves.
- Avoid bringing in unnecessary **papers** in the clean room. Never deposit paper in the working area of the flow box.

3.3.2 Handling of Chemicals

- Beakers with **chemicals** must be covered and clearly labeled with at least the following information:
 - - name of substance
 - - molecular formula
 - - date of filling
 - - name of responsible persons
- **Acids and bases used** for etching are **strongly corrosive**. Before starting work, take absolute heed of the first aid instructions to specific chemicals in Chapter 3.4.
- Solvents may only be heated under supervision on the heating plate.
- Do not clean hot heating plates with solvents.
- Use **photo varnish only under yellow light**.
- **Dispose your chemicals** after use, following the given guidelines (introduction) and clean your glassware.

3.3.3 Devices

- Check **before turning on devices**, that all necessary sources (cold water, compressed air, etc.) are available.
- After the end of work, make sure that **devices** and sources **are turned off** properly (take into account cooling time, etc.).
- **Defective devices** including **corroded or defective cables and plugs** must be immediately reported for repairs to a supervisor. Do not try to repair the damage yourself (insulating tape).

Risk Phrases

R 1	Explosive when dry.	R 42	May cause sensitization by inhalation.	R 36/37/38	Irritating to eyes, respiratory system and skin.
R 2	Risk of explosion by shock, friction, fire or other sources of ignition.	R 43	May cause sensitization by skin contact.	R 37/38	Irritating to respiratory system and skin.
R 3	Extreme risk of explosion by shock, friction, fire or other sources of ignition.	R 44	Risk of explosion if heated under confinement.	R 39/23	Toxic: danger of very serious irreversible effects through inhalation.
R 4	Forms very sensitive explosive metallic compounds.	R 45	May cause cancer.	R 39/24	Toxic: danger of very serious irreversible effects in contact with skin.
R 5	Heating may cause an explosion.	R 46	May cause heritable genetic damage.	R 39/25	Toxic: danger of very serious irreversible effects if swallowed.
R 6	Explosive with or without contact with air.	R 48	Danger of serious damage to health by prolonged exposure.	R 39/23/24	Toxic: danger of very serious irreversible effects through inhalation and in contact with skin.
R 7	May cause fire.	R 49	May cause cancer by inhalation.	R 39/23/25	Toxic: danger of very serious irreversible effects through inhalation and if swallowed.
R 8	Contact with combustible material may cause fire.	R 50	Very toxic to aquatic organisms.	R 39/24/25	Toxic: danger of very serious irreversible effects in contact with skin and if swallowed.
R 9	Explosive when mixed with combustible material.	R 51	Toxic to aquatic organisms.	R 39/23/24/25	Toxic: danger of very serious irreversible effects through inhalation, in contact with skin and if swallowed.
R 10	Flammable.	R 52	Harmful to aquatic organisms.	R 39/26	Very toxic: danger of very serious irreversible effects through inhalation.
R 11	Highly flammable.	R 53	May cause long-term adverse effects in the aquatic environment.	R 39/27	Very toxic: danger of very serious irreversible effects in contact with skin.
R 12	Extremely flammable.	R 54	Toxic to flora.	R 39/28	Very toxic: danger of very serious irreversible effects if swallowed.
R 14	Reacts violently with water.	R 55	Toxic to fauna.	R 39/26/27	Very toxic: danger of very serious irreversible effects through inhalation and in contact with skin.
R 15	Contact with water liberates extremely flammable gases.	R 56	Toxic to soil organisms.	R 39/26/28	Very toxic: danger of very serious irreversible effects through inhalation and if swallowed.
R 16	Explosive when mixed with oxidizing substances.	R 57	Toxic to bees.	R 39/27/28	Very toxic: danger of very serious irreversible effects in contact with skin and if swallowed.
R 17	Spontaneously flammable in air.	R 58	May cause long-term adverse effects in the environment.	R 39/26/27/28	Very toxic: danger of very serious irreversible effects through inhalation, in contact with skin and if swallowed.
R 18	In use, may form flammable / explosive vapour-air mixture.	R 59	Dangerous for the ozone layer.	R 40/20	Harmful: possible risk of irreversible effects through inhalation.
R 19	May form explosive peroxides.	R 60	May impair fertility.	R 40/21	Harmful: possible risk of irreversible effects in contact with skin.
R 20	Harmful by inhalation.	R 61	May cause harm to the unborn child.	R 40/22	Harmful: possible risk of irreversible effects if swallowed.
R 21	Harmful in contact with skin.	R 62	Possible risk of impaired fertility.	R 40/20/21	Harmful: possible risk of irreversible effects through inhalation and in contact with skin.
R 22	Harmful if swallowed.	R 63	Possible risk of harm to the unborn child.	R 40/20/22	Harmful: possible risk of irreversible effects through inhalation and if swallowed.
R 23	Toxic by inhalation.	R 64	May cause harm to breastfed babies.	R 40/21/22	Harmful: possible risk of irreversible effects in contact with skin and if swallowed.
R 24	Toxic in contact with skin.	R 65	Harmful: may cause lung damage if swallowed.	R 40/20/21/22	Harmful: possible risk of irreversible effects through inhalation, in contact with skin and if swallowed.
R 25	Toxic if swallowed.			R 42/43	May cause sensitization by inhalation and skin contact.
R 26	Very toxic by inhalation.			R 48/20	Harmful: danger of serious damage to health by prolonged exposure through inhalation.
R 27	Very toxic in contact with skin.			R 48/21	Harmful: danger of serious damage to health by prolonged exposure in contact with skin.
R 28	Very toxic if swallowed.			R 48/22	Harmful: danger of serious damage to health by prolonged exposure if swallowed.
R 29	Contact with water liberates toxic gas.			R 48/20/21	Harmful: danger of serious damage to health by prolonged exposure through inhalation and in contact with skin.
R 30	Can become highly flammable in use.			R 48/20/22	Harmful: danger of serious damage to health by prolonged exposure through inhalation and if swallowed.
R 31	Contact with acids liberates toxic gas.			R 48/21/22	Harmful: danger of serious damage to health by prolonged exposure in contact with skin and if swallowed.
R 32	Contact with acids liberates very toxic gas.			R 48/20/21/22	Harmful: danger of serious damage to health by prolonged exposure through inhalation, in contact with skin and if swallowed.
R 33	Danger of cumulative effects.			R 48/23	Toxic: danger of serious damage to health by prolonged exposure through inhalation.
R 34	Causes burns.			R 48/24	Toxic: danger of serious damage to health by prolonged exposure in contact with skin.
R 35	Causes severe burns.			R 48/25	Toxic: danger of serious damage to health by prolonged exposure if swallowed.
R 36	Irritating to eyes.			R 48/23/24	Toxic: danger of serious damage to health by prolonged exposure through inhalation and in contact with skin.
R 37	Irritating to respiratory system.			R 48/23/25	Toxic: danger of serious damage to health by prolonged exposure through inhalation and if swallowed.
R 38	Irritating to skin.			R 48/24/25	Toxic: danger of serious damage to health by prolonged exposure in contact with skin and if swallowed.
R 39	Danger of very serious irreversible effects.			R 50/53	Very toxic to aquatic organisms, may cause long-term adverse effects in the aquatic environment.
R 40	Possible risks of irreversible effects.			R 51/53	Toxic to aquatic organisms, may cause long-term adverse effects in the aquatic environment.
R 41	Risk of serious damage to eyes.			R 52/53	Harmful to aquatic organisms, may cause long-term adverse effects in the aquatic environment.

Combination R Phrases

Safety Phrases

- S 1 Keep locked up.
- S 2 Keep out of the reach of children
- S 3 Keep in a cool place
- S 4 Keep away from living quarters.
Keep contents under...(appropriate liquid to be specified by the manufacturer).
- S 5 Keep under...(inert gas to be specified by the manufacturer).
- S 6 Keep container tightly closed.
- S 7 Keep container dry.
- S 8 Keep container in a wellventilated place.
- S 12 Do not keep the container sealed.
- S 13 Keep away from food, drink and animal feedingstuffs.
Keep away from...(incompatible materials to be indicated by the manufacturer).
- S 14 Keep away from heat.
- S 16 Keep away from sources of ignition No smoking.
- S 17 Keep away from combustible material.
- S 18 Handle and open container with care.
- S 20 When using do not eat or drink.
- S 21 When using do not smoke.
- S 22 Do not breathe dust.

Do not breathe gas/fumes/vapour/spray (appropriate wording to be specified by the manufacturer).
- S 23 Avoid contact with skin.
- S 24 Avoid contact with eyes.
In case of contact with eyes, rinse immediately with plenty of water and seek medical advice.
- S 25 Take off immediately all contaminated clothing.
After contact with skin, wash immediately with plenty of...(to be specified by the manufacturer).
- S 26 Do not empty into drains.
- S 29 Never add water to this product.
- S 30 Take precautionary measures against static discharges.
This material and its container must be disposed of in a safe way.
- S 33 Wear suitable protective clothing.
- S 34 Wear suitable gloves.

In case of insufficient ventilation, wear suitable respiratory equipment.
- S 36 Wear eye/face protection.
To clean the floor and all objects contaminated by this material, use...(to be specified by the manufacturer).
- S 37 In case of fire and/or explosion do not breathe fumes.

- S 42 During fumigation/spraying wear suitable respiratory equipment (appropriate wording to be specified by the manufacturer).
- S 43 In case of fire, use...(indicate in the space the precise type of firefighting equipment. If water increases risk, add 'Never use water').
- S 45 In case of accident or if you feel unwell, seek medical advice immediately (show the label where possible).
- S 46 If swallowed, seek medical advise immediately and show this container or label.
- S 47 Keep at temperature not exceeding...degree C (to be specified by the manufacturer).
- S 48 Keep wet with...(appropriate material to be specified by the manufacturer).
- S 49 Keep only in the original container.
- S 50 Do not mix with...(to be specified by the manufacturer).
- S 51 Use only in wellventilated areas.
- S 52 Not recommended for interior use on large surface areas.
- S 53 Avoid exposure obtain special instructions before use.
- S 56 Dispose of this material and its container at hazardous or special waste collection point.
- S 57 Use appropriate container to avoid environmental contamination.
- S 59 Refer to manufacturer/supplier for information on recovery/recycling.
This material and its container must be disposed of as hazardous waste.
- S 60 Avoid release to the environment. Refer to special instructions/Safety data sheets.
- S 61 If swallowed, do not induce vomiting; seek medical advice immediately and show this container or label.
- S 62

Combination S Phrases

- S 1/2 Keep locked up and out of the reach of children.
- S 3/7 Keep container tightly closed in a cool place.
- S 3/9/14 Keep in a cool, wellventilated place away from... (incompatible materials to be indicated by the manufacturer).
- S 3/9/14/49 Keep only in the original container in a cool, wellventilated place away from...(incompatible materials to be indicated by the manufacturer).
- S 3/9/49 Keep only in the original container in a cool, wellventilated place.
Keep in a cool place away from...(incompatible materials to be indicated by the manufacturer).
- S 7/8 Keep container tightly closed and dry.
- S 7/9 Keep container tightly closed and in a wellventilated place.
Keep container tightly closed and at a temperature not exceeding...degree C (to be specified by the manufacturer).
- S 7/47
- S 20/21 When using do not eat, drink or smoke.
- S 24/25 Avoid contact with skin and eyes.
Do not empty into drains, dispose of this material and its container at hazardous or special waste collection points.
- S 29/56
- S 36/37 Wear suitable protective clothing and gloves.
- S 36/37/39 Wear suitable protective clothing, gloves and eye/face protection.
- S 36/39 Wear suitable protective clothing and eye/face protection.
- S 37/39 Wear suitable gloves and eye/face protection.
Keep only in the original container at a temperature not exceeding...degree C (to be specified by the manufacturer).
- S 47/49

3.4.1 Explanation of Chemical List

Row 1 Name and linear formula of substance







Row 2 Poison class according to the poison statutes of Switzerland

All poisons in public use are grouped by the Department of Health into 5 poison classes. This corresponds to **1 as the highest and 5 as the lowest hazard level**. “-“ means poison class free.

To judge the acute danger, the acute oral lethal doses are utilized. They are based, in most cases, on toxicological data or otherwise given as rates:

Poison class 1	up to 5 mg/kg body weight
Poison class 2	5 - 50 mg/kg ”
Poison class 3	50 - 500 mg/kg ”
Poison class 4	500 - 2000 mg/kg ”
Poison class 5	2000 - 5000 mg/kg ”

Row 3 Risk warnings in accordance with the poison statutes of Switzerland

	Harmful	Inhalation, ingestion, or absorption through the skin is harmful. Possible irreversible damage through single, repeated, or longer exposure. Avoid contact with the human body, also inhalation of vapors. Consult physician if feeling unwell.
	Irritant	Materials with irritable effects on skin, eyes, and respiratory organs. Do not inhale vapors and avoid contact with skin and eyes.
	Flammable	Self-igniting or water-reactive materials, liquids with low flash point (<math><0^{\circ}\text{C}</math> or <math><35^{\circ}\text{C}</math>), gases which ignite at normal temperature and pressure and materials that are easily flammable. Avoid any contact with ignition source and if necessary, air.
	Oxidizing	Can burn combustible materials or promote random fires, making fire fighting more difficult. Avoid every contact with flammable materials.
	Corrosive	Living tissues but also many materials would be destroyed upon contact. Do not inhale vapors and avoid contact with skin, eyes, and clothing.
	Toxic or highly toxic	Inhalation, ingestion, or absorption through the skin leads to extensive health damage or death. Possibility of irreversible damage through single, repeated or longer exposure. Avoid all contact with the human body and immediately see physician if feeling unwell.

4. row First aid measures that must be taken if accidents occur with the concerned chemicals.











Abbreviations:

dev. = development







ch. =chapter











SI = stomach-intestine









muc.mem = mucous membranes

CHEMICAL NAME	PC	RISK	EFFECT/SYMPTOMS	FIRST AID
A				
Acetic acid, 25 - 90% CH ₃ COOH	4		Vapor extremely irritating to muc.mem., pungent odor (hood!); after longer inhalation damage to teeth; strongly caustic to skin and eyes	Rinse thoroughly after skin or eye contact; drink plenty of water after swallowing, do not induce vomiting ; seek fresh air after inhalation
Acetic acid, > 90% CH ₃ COOH	3		Vapor extremely irritating to muc.mem., pungent odor (hood!); after longer inhalation damage to teeth; strongly caustic to skin and eyes	Rinse thoroughly after skin or eye contact; drink plenty of water after swallowing, do not induce vomiting; seek fresh air after inhalation
Acetic anhydride (CH ₃ CO) ₂ O	3	 	Strongly tear inducing and irritating to respiratory tract (hood!); extremely caustic to eyes and skin	Rinse thoroughly after skin or eye contact, eye doctor!; seek fresh air after inhalation
Acetone CH ₃ -CO-CH ₃	4		Can irritate skin, eyes and respiratory organs; possible absorption through skin and inhalation; headache, nausea, itchy throat	Rinse thoroughly after skin or eye contact, induce vomiting after swallowing (refer to Ch. 2)
Acetonitrile CH ₃ CN	2	 	Causes tearing of eyes, toxic upon skin contact, inhalation and swallowing (interruption of O ₂ - transport, internal asphyxiation)	Immediately remove saturated clothes, rinse skin thoroughly, see physician if dizziness, nausea, ringing in the ears, impaired vision, etc. occur
Ammonia, gas NH ₃			Refer to the chapter, "Dangerous Gases"	
Ammonia, solution, <10% NH₃ NH ₄ OH	4		Irritating or caustic to eyes, skin and respiratory organs; headache, numbness	Rinse thoroughly after skin or eye contact; drink water after swallowing, do not induce vomiting
Ammonia, solution, 10-35% NH ₃ ; NH ₄ OH	2-3		Irritating or caustic to eyes, skin and respiratory organs; headache, numbness; fumes can cause breathing paralysis (hood!);	Drink water after swallowing, do not induce vomiting; seek plenty of fresh air after inhalation, physician, if respiratory arrest refer to Ch.2
Ammonium acetate CH ₃ COONH ₄	5		Slightly irritating to skin and eyes; do not breathe dust (hood)	Rinse thoroughly after skin or eye contact; drink water after swallowing, do not induce vomiting; after inhalation fresh air
Ammonium carbonate NH ₄ HCO ₃	4		Generally harmless, weakly basic	
Ammonium chloride NH ₄ Cl	4		Can irritate skin, eyes and respiratory tract (do not inhale fumes, hood!); headache, numbness	Rinse well after skin or eye contact; after swallowing induce large amounts of vomiting (refer to Ch. 2); after inhalation seek physician
Ammonium fluoride NH ₄ F	3		Binds to the body's own calcium after intake ; irritating to muc.mem., skin and eyes (also dust or vapors!; hood!); after inhalation possible respiratory arrest; chronic bone changes, damaging to teeth	Wash well after skin or eye contact, physician; after swallowing drink plenty of water, do not induce vomiting! If so, rinse off vomit well, physician; seek fresh air after inhalation, physician

CHEMICAL NAME	PC	RISK	EFFECT/SYMPTOMS	FIRST AID
Ammonium hydroxide			Refer to Ammonia, solution	
Ammonium nitrate NH ₄ NO ₃	4		Explosive with org. materials!; in case of fire possible lung edema from nitrous gas; formation of methamoglobin.	Induce vomiting after swallowing (refer to Ch.2); physician; after inhalation fresh air; physician
Ammonium sulfocyanate NH ₄ SCN	3	 _n	Harmful to muc.mem., skin and eyes, develops toxic gas upon contact with acid (CO, hood!)	Rinse well after skin or eye contact; drink water after swallowing, do not induce vomiting; after inhalation fresh air, poss. physician
Ammonium sulfate (NH ₄) ₂ SO ₄	4		Generally harmless	
Amyl alcohol e.g. CH ₃ (CH ₂) ₄ OH	4	  _n	Irritating to muc.mem. and respiratory tract, skin and eyes; narcotic (hood); headache, nausea	Rinse well after skin or eye contact, eye doctor; induce vomiting after swallowing (refer to Ch.2), after inhalation of large amounts fresh air
B				
Barium salts, e.g. -chloride BaCl ₂	2	 _n	Already less than 1 g induces dangerous heart muscle contractions, SI and CNS disturbances; irritating to muc.mem. (dust, hood!)	Rinse well after skin or eye contact; drink water after swallowing, induce vomiting (refer to Ch. 2), physician!; after inhalation fresh air, physician
Benzine C ₆ H ₆	1	 	Lethal dose 20 ml; narcotic after inhalation (hood!), after swallowing SI-disturbances, irritating to skin and muc.mem., skin resorption; carcinogen	After inhalation fresh air, rinse well after skin contact, after eye contact blow in (evaporation), then rinse well, physician; after swallowing do not induce vomiting !, physician induce vomiting !, physician
Boric acid H ₃ BO ₃	4	 _n	Irritating to eyes, skin, and lungs; causes chronic damage to kidneys, blood and CNS (hood, gloves, glasses!)	Rinse well after skin or esp. eye contact, eye doctor!; drink plenty of water after swallowing, do not induce vomiting , physician; after inhalation fresh air, physician
Bromine Br ₂	2	 	Lethal dose 1 ml, upon inhalation extremely toxic (hood!); liquids cause serious burns on skin and muc.mem., vapors irritate eyes and muc.mem.	Rinse thoroughly after skin or eye contact, eye doctor; after inhalation fresh air, physician
Bromoform CHBr ₃	3		Irritating to eyes , skin and respiratory tract; narcotic in higher doses; skin resorption possible	Rinse thoroughly after skin or eye contact, seek fresh air after inhalation, poss. resuscitation, physician







CHEMICAL NAME	PC	RISK	EFFECT/SYMPTOMS	FIRST AID
Boric acid H ₃ BO ₃	4		Irritating to eyes, skin, and lungs; causes chronic damage to kidneys, blood and CNS (hood, gloves, glasses!)	Rinse well after skin or esp. eye contact, eye doctor!; drink plenty of water after swallowing, do not induce vomiting, physician; after inhalation fresh air, physician
Bromine Br ₂	2		Lethal dose 1 ml, upon inhalation extremely toxic (hood!); liquids cause serious burns on skin and muc.mem., vapors irritating to eyes and muc.mem.	Rinse thoroughly after skin or eye contact, eye doctor; after inhalation fresh air, physician
Bromoform CHBr ₃	3		Irritate eyes, skin and respiratory tract; narcotic in higher doses; skin resorption possible	Rinse thoroughly after skin or eye contact, seek fresh air after inhalation, poss. resuscitation, physician
Butanol C ₄ H ₁₀ O	4		Irritating to eyes, skin and respiratory tract; burning eyes; headache, dizziness; inflammations	Rinse thoroughly after skin or eye contact; eye doctor!; seek fresh air after inhalation; drink water after swallowing, do not induce vomiting, physician
C				
Calcium chloride CaCl ₂	-		After swallowing may cause large amounts of SI-irritations	After swallowing induce a great deal of vomiting (refer to Ch 2)
Calcium sulfate CaSO ₄	-		Generally harmless	
Carbon tetrachloride CCl ₄	1		Lethal dose up to 2 - 4 ml; dangerous skin resorption possible; narcotic, respiratory arrest; damaging to liver, CNS, kidneys (gloves, glasses, hood!)	Rinse thoroughly after skin or eye contact, physician!; seek fresh air after inhalation; drink plenty of water after swallowing, do not induce vomiting, physician in all cases!
Caustic soda			Refer to Sodium hydroxide	
Celite	-		Generally harmless	
Chlorobenzene C ₆ H ₅ Cl	-		Depressive effects on CNS; removes oils from skin, inflammation possible; skin resorption possible	Rinse thoroughly after skin or eye contact; eye doctor!; seek fresh air after inhalation; drink water after swallowing, do not induce vomiting, physician
Chloroform CHCl ₃	2		Damaging to heart, liver and kidneys (carcinogen); narcotic; possible disturbances to heart rhythm after inhalation; skin resorption possible	Rinse well after skin contact; after eye contact blow in (evaporation), then rinse well, eye doctor; seek fresh air after inhalation, poss. physician; do not induce vomiting after swallowing, physician

CHEMICAL NAME	PC	RISK	EFFECT/SYMPTOMS	FIRST AID
Citric acid <chem>HOC(COOH)(CH2COOH)2</chem>	4		Burns	Rinse thoroughly after skin or eye contact; drink water after swallowing, do not induce vomiting
Cobalt-(II)-chloride <chem>CoCl2</chem>	3		Toxic when swallowed (greatly reduces erythrocyte prod.; heart failure); do not breathe dust; avoid contact with skin and eyes (hood, gloves, glasses)	Rinse thoroughly after skin or eye contact; after inhalation fresh air; physician; drink water after swallowing, do not induce vomiting ; physician
Cobalt-(II)-nitrate <chem>Co(NO3)2.</chem>	2	 	Dangerous to health when swallowed, do not breathe dust; avoid contact with skin and eyes (hood, gloves, glasses!)	Rinse thoroughly after skin or eye contact; after inhalation fresh air; physician; drink water after swallowing, do not induce vomiting ; physician
Cobalt-(II)-sulfate <chem>CoSO4</chem>	2		Inhalation and swallowing dangerous, SI-irritant, CNS-damaging; irritating to skin, eyes and respiratory tract (gloves, glasses, hood!)	After swallowing do not induce vomiting , physician!; after inhalation fresh air, physician; rinse well after skin or eye contact, eye doctor
Copper salts, e.g.-chloride <chem>CuCl2</chem>	3		Irritating to skin and eyes; hemolytic; leads to SI-disturbances; copper salts can cause methamoglobin formation; heed label, R- and S-phrases!	Rinse thoroughly after skin or eye contact; eye doctor; drink plenty of water after swallowing, do not induce vomiting , physician
Cyclohexene <chem>C6H12</chem>	4		Skin irritant, if not allowed to evaporate; high vapor concentrations irritate eyes and muc.mem.; after swallowing SI-disturbances, numbness, nausea, cough	Rinse thoroughly after skin or eye contact, remove clothes; seek fresh air after inhalation; after swallowing do not induce vomiting , physician
D				
Dichloromethane <chem>CH2Cl2</chem>	4		Triggers formation of CO-hemoglobin ->narcotic, suspected as carcinogen; lethal dose approx. 18 ml	Rinse well after skin contact, remove clothing, moisturize skin; afer eye contact blow in (evaporation), rinse well; seek fresh air after inhalation; induce vomiting after swallowing, physician
N,N-Diethylaniline	4		Lethal upon inhalation, swallowing or contact with skin (gloves, glasses, hood!)	Seek fresh air after inhalation, physician!; induce vomiting after swallowing, physician; rinse thoroughly after skin or eye contact
Diethylether <chem>(C2H5)2O</chem>	4	 Peroxide form.!	Narcotic; strong remover of oils from skin, high vapor concentration irritating to skin and muc.mem. (hood!)	Rinse thoroughly after skin or eye contact; moisturize skin; seek fresh air after inhalation
Dimethoxyethane <chem>CH3OCH2CH2OCH3</chem>	-		Slightly irritating to skin and eyes; narcotic in higher doses; stomach irritations after swallowing	Rinse thoroughly after skin or eye contact; moisturize skin; seek fresh air after inhalation; drink plenty of water after swallowing, do not induce vomiting

CHEMICAL NAME	PC	RISK	EFFECT/SYMPTOMS	FIRST AID
N,N-Dimethylformamide	3		Irritating to eyes; damaging upon contact with skin or inhalation; teratogenic (gloves, hood!) (A Teratogen is a chemical which may cause non-heritable genetic mutations or malformations in the developing foetus.)	Rinse thoroughly after skin or eye contact; eye doctor!; drink plenty of water after swallowing, do not induce vomiting!; physician!; seek fresh air after inhalation, physician
Dimethylsulfoxide (CH ₃) ₂ SO	-		Undiluted can cause redness of skin	Rinse thoroughly after skin or eye; drink plenty of water after swallowing
Dipotassium hydrogenphosphate K ₂ HPO ₄	-		Generally harmless	
Disodium hydrogenphosphate Na ₂ HPO ₄	5		Generally harmless	
Dioxane C ₄ H ₈ O ₂	4	  _n	Extremely irritating to eyes; narcotic (hood!), skin resorption possible; danger esp. after long repeated exposure	Rinse thoroughly after skin or eye contact; drink plenty of water after swallowing, do not induce vomiting ; seek fresh air after inhalation
E				
Ethanol C ₂ H ₅ OH	-		Skin resorption possible (gloves!); dizziness; vomiting; nerve and cell toxin	Rinse thoroughly after skin or eye contact; drink water after swallowing, induce vomiting (refer to Ch.2); seek fresh air after inhalation
Ethidium bromide C ₂₁ H ₂₀ BrN ₃	Not classed		Mutagenic (blocks RNA-synthesis); skin resorption possible; avoid any kind of direct contact (glasses, gloves, hood!)	After skin contact or swallowing seek physician
Ethyl acetate CH ₃ COOC ₂ H ₅	-		Vapor irritating to muc.mem., narcotic in higher doses (hood!); removes oils from skin	Rinse thoroughly after skin or eye contact, moisturize skin; seek fresh air after inhalation; drink water after swallowing, do not induce vomiting , physician
Ethylbromoacetate BrCH ₂ COOC ₂ H ₅	1		Extremely toxic upon skin contact, inhalation and swallowing (hood!)	Rinse thoroughly after skin contact; drink water after swallowing, do not induce vomiting ; after inhalation fresh air; in every case physician!
F				
Formaldehyde, 5 - 25 % HCHO	-	 _n	Disinfectant; irritating to eyes, skin and respiratory tract (hood!); contact sensitization possible (gloves!); after swallowing strong irritation of esophagus and SI-tract	Rinse thoroughly after skin or eye contact; seek fresh air after inhalation; drink plenty of water after swallowing, do not induce vomiting





CHEMICAL NAME	PC	RISK	EFFECT/SYMPTOMS	FIRST AID
Formaldehyde , > 25 % HCHO	3		Strong irritant of eyes, skin and respiratory tract, pungent odor (hood!); contact sensitization possible (gloves!); after swallowing strong irritation of esophagus and SI-tract, 60 ml lethal	Rinse thoroughly after skin or eye contact; seek fresh air after inhalation; drink plenty of water after swallowing, do not induce vomiting, physician
Formic acid , 10 - 30% solution; HCOOH	4		Irritating to skin and eyes	Rinse thoroughly after skin or eye contact
Formic acid , >25%HCOOH	3		Irritating to eyes and skin; inhalation of fumes can lead to lung irritations or even edema (hood!)	Rinse thoroughly after skin or eye contact; seek fresh air after inhalation, physician; drink water after swallowing, do not induce vomiting!, physician
G, H				
Gasoline			Refer to Petroleum	
Glacial acetic acid			Refer to Acetic acid > 90%	
Glycerol HOCH ₂ CH(OH)CH ₂ OH.aq	-		Not harmful diluted, in water-free form strongly irritating to muc.mem., hemolytic	Rinse thoroughly after skin or eye contact; seek fresh air after inhalation; drink water after swallowing, with large amounts induce vomiting (refer to Ch.2)
Graphite C	-		Generally harmless	
Heptane CH ₃ (CH ₂) ₅ CH ₃	4		Concentrated vapor irritating to eyes, skin and muc.mem., slightly narcotic (hood!); removes oil from skin; painful SI-irritations after swallowing	Rinse thoroughly after skin or eye contact, moisturize skin; seek fresh air after inhalation; drink plenty of water after swallowing, do not induce vomiting, physician
Hexane CH ₃ (CH ₂) ₄ CH ₃	4		Concentrated vapor irritating to eyes, skin, and muc.mem., slightly narcotic (hood!); leads to chronic degeneration of peripheral nerves	Rinse thoroughly after skin or eye contact, moisturize skin; seek fresh air after inhalation; induce vomiting after swallowing
Hydrobromic acid HBr.aq	2		Strongly irritating or caustic to skin and muc.mem., esp. eyes and respiratory tract	Rinse thoroughly after skin or eye contact, eye doctor; drink plenty of water after swallowing, do not induce vomiting, physician; after inhalation physician
Hydrochloric acid , < 1% HCl	5		Irritating to eyes, skin and respiratory organs	Rinse thoroughly after skin or eye contact; seek fresh air after inhalation, drink plenty of water after swallowing, do not induce vomiting

CHEMICAL NAME	PC	RISK	EFFECT/SYMPTOMS	FIRST AID
Hydrochloric acid , 1-3% HCl	4		Irritating to eyes, skin and respiratory organs	Rinse thoroughly after skin or eye contact; seek fresh air after inhalation, drink plenty of water after swallowing, do not induce vomiting
Hydrochloric acid , 3-10% HCl	3		Irritating to eyes, skin and respiratory organs	Rinse thoroughly after skin or eye contact; eye doctor; seek fresh air after inhalation, drink plenty of water after swallowing, do not induce vomiting , physician
Hydrochloric acid , 10-25% HCl	2		Irritating to skin and muc.mem.; vapors irritating to eyes and respiratory tract (hood!)	Rinse thoroughly after skin or eye contact; seek fresh air after inhalation, drink plenty of water after swallowing, do not induce vomiting , physician
Hydrochloric acid , > 25% HCl	2		Strongly caustic to skin and muc.mem.; vapors strongly irritating to eyes and respiratory tract, danger of suffocation!, chronic teeth damage	Rinse thoroughly after skin or eye contact, eye doctor!; seek fresh air after inhalation; drink plenty of water after swallowing, do not induce vomiting , physician
Hydrofluoric acid HF.aq	1		Strongly caustic to deeper tissue layers after 1 - 2 days latency, difficult to heal abscesses, avoid any skin contact!; vapor irritating to respiratory tract, teeth damage (spec. gloves; safety shield, hood);	Immediately rinse thoroughly also after <i>possible</i> skin or eye contact, physician!; seek fresh air after inhalation, physician! after any possible contact also without symptoms seek physician (latency)!
Hydrogen peroxide , < 60% H ₂ O ₂	3		Irritating to eyes and respiratory tract (up to 25% weak, up to 35% strong)	Seek fresh air after inhalation; drink plenty of water after swallowing, do not induce vomiting ; rinse thoroughly after skin or eye contact
Hydrogen peroxide , > 60% H ₂ O ₂	3		Danger esp. upon eye contact; irritating to respiratory tract and skin	Seek fresh air after inhalation; drink plenty of water after swallowing, do not induce vomiting ; rinse thoroughly after skin or eye contact, physician!
Hydrogen sulfide H ₂ S	2		Refer to chapter "Dangerous Gases"	
I, J				
Iodine, free I ₂	2		Damaging to skin, respiratory tract and organs (gloves, hood!)	Rinse thoroughly after skin or eye contact; seek fresh air after inhalation; drink water after swallowing, do not induce vomiting , physician
Iodine, dissolved and compounds	-		Irritating to skin, eyes and muc.mem.; strong SI-discomfort after swallowing	Rinse thoroughly after skin or eye contact; drink water after swallowing, physician!





CHEMICAL NAME	PC	RISK	EFFECT/SYMPTOMS	FIRST AID
Iron salts, e.g.. -(III)-chloride FeCl ₂	3		Extremely irritating to skin, muc.mem. and esp. eyes (gloves, glasses!), also dangerous to waters	Rinse thoroughly after skin or eye contact, physician!; drink plenty of water after swallowing, do not induce vomiting, physician; after inhalation seek fresh air, physician
Isoamyl alcohol			Refer to Amyl alcohol	
Isooctane (CH ₃) ₂ CHCH ₂ C(CH ₃) ₃	5		Narcotic, headache, dizziness; painful SI-irritation after swallowing	After inhalation fresh air; drink water after swallowing, do not induce vomiting , evtl. physician; rinse thoroughly after skin or eye contact
Isopentyl alcohol			Refer to Amyl alcohol	
Isopropanol (CH ₃) ₂ CHOH	5		Irritating to muc.mem.; narcotic, danger of respiratory paralysis in higher doses (hood!)	Rinse thoroughly after skin or eye contact; seek fresh air after inhalation; induce vomiting after swallowing (refer to. 2)
K, L				
Lead Pb	-		SI-irritating, causes heart rhythm disturbances, damage to nerves, blood and kidney; do not breathe dust (hood!); danger through cumulative effects	Rinse thoroughly after skin or eye contact, induce vomiting after swallowing (refer to Ch.2)
Lead compounds, gen.			Damaging to nerves and blood; resorption through skin possible; do not breathe dust! dangerous cumulative effects; heed label, R- and S-phrases, bring information along	Rinse thoroughly after skin or eye contact, remove clothing; induce vomiting after swallowing (refer to Ch.2)
Ligroin (Benzine)	5		Generally harmless	
Lithium salts, e.g.-chloride, LiCl	-	 	Irritating to skin, respiratory organs and eyes	Rinse thoroughly after skin or eye contact; eye doctor; drink plenty of water after swallowing, do not induce vomiting , physician; seek fresh air after inhalation







CHEMICAL NAME	PC	RISK	EFFECT/SYMPTOMS	FIRST AID
M, N				
Magnesium salts, e.g. chloride, Lsg.; $MgCl_2 \cdot 6H_2O$	-		Irritating to skin and eyes	Rinse thoroughly after skin or eye contact;
Manganese salts, e.g. dioxide MnO_2	5		Acute irritation of respiratory tract and muc.mem.; chronic CNS-damage; do not breathe dust (hood!)	Seek fresh air after inhalation, physician!
Mercury salts, e.g. chloride, Hg_2Cl_2 -(I)-	2		Irritating to eyes, respiratory organs and skin, damaging after swallowing (gloves, hood!)	Rinse thoroughly after skin or eye contact; eye doctor; seek fresh air after inhalation; induce vomiting after swallowing (refer to Ch. 2), physician
Methanol CH_3OH	3		Acute up to 5 ml orally lethal, possible resorption of toxic amounts through skin; chronic irritation of muc.mem., dizziness, headache (hood!)	Rinse thoroughly after skin or eye contact; remove clothes; immediately drink plenty of water after swallowing, physician!; seek plenty of fresh air after inhalation
Methyl acetate CH_3COOCH_3	3		Irritating to muc.mem.; narcotic in higher doses (hood!); removes oils from skin, skin resorption possible	Rinse thoroughly after skin or eye contact, moisturize skin; seek fresh air after inhalation; drink water after swallowing, do not induce vomiting
Methyl benzoate $C_6H_5COOCH_3$	-		Generally harmless	
Methylene chloride CH_2Cl_2			Refer to Dichlormethane	
Nitric acid, 20-70% HNO_3	2		Irritating to eyes, skin and muc.mem., lung edema possible (hood!)	Rinse thoroughly after skin or eye contact; eye doctor; seek fresh air after inhalation; drink plenty of water after swallowing, do not induce vomiting, physician
Nitric acid, > 70% HNO_3	2		Extremely strong irritant to skin and muc.mem., badly healing wounds; mortal danger upon inhalation of fumes or gases (lung edema, methemoglobin formation., hood!)	Rinse thoroughly after skin or eye contact; eye doctor; seek fresh air after inhalation; drink plenty of water after swallowing, do not induce vomiting, physician
Nickel salts, e.g. chloride $NiCl_2$	2		Carcinogenic vapors; contact sensibility possible, avoid skin contact (hood, gloves!); after swallowing causes much SI-irritations	Rinse thoroughly after skin or eye contact; wash skin with soap drink water after swallowing, induce vomiting (refer to Ch.2); seek fresh air after inhalation, physician

CHEMICAL NAME	PC	RISK	EFFECT/SYMPTOMS	FIRST AID
O, P, Q				
Oxalic acid HOOC-COOH	2		Strongly irritating to skin and muc.mem. and eyes, resorption possible (hood, gloves; glasses!); possible heart-respiratory-failure and kidney damage; also chronic small amounts are dangerous	Rinse thoroughly after skin or eye contact; eye doctor!; drink plenty of water after swallowing, do not induce vomiting !, physician!; seek fresh air after inhalation, physician!
i-/n-Pentane CH ₃ (CH ₂) ₃ CH ₃	4		Upon inhalation dizziness, nausea, narcotic in higher doses (hood!); after swallowing leads to painful SI-irritations	Seek fresh air after inhalation, poss. physician; drink plenty of water after swallowing, do not induce vomiting , physician; wash well after eye contact
Perchloric acid, 10-50% HClO₄	1		Strongly irritating to skin and muc.mem., badly healing wounds; extremely irritating vapors, possible lung edema	Rinse thoroughly after skin or eye contact; eye doctor!; drink plenty of water after swallowing, do not induce vomiting !, physician!; seek fresh air after inhalation, immed. physician!
Perchloric acid, > 50 % HClO₄	1		Strongly irritating to skin and muc.mem., badly healing wounds; extremely irritating vapors, possible lung edema	Rinse thoroughly after skin or eye contact; eye doctor!; drink plenty of water after swallowing, do not induce vomiting !, physician!; seek fresh air after inhalation, immed. physician!
Petroleum	5		Conc. vapors slightly narcotic; removes oils from skin; SI-irritations after swallowing	Seek fresh air after inhalation; rinse thoroughly after skin or eye contact; wash skin with soap; drink water after swallowing, do not induce vomiting, physician
Petroleum ether C ₅ H ₁₂	4		Conc. vapors irritating to eyes and respiratory tract, narcotic; fluids narcotic, irritating to skin	Seek fresh air after inhalation; rinse thoroughly after skin or eye contact; wash skin with soap; drink water after swallowing, do not induce vomiting, physician
Phosphoric acid, < 5 % H ₃ PO ₄	5		Irritating to skin, eyes and muc.mem.	Rinse thoroughly after skin or eye contact; seek fresh air after inhalation; drink plenty of water after swallowing, do not induce vomiting , physician
Phosphoric acid, 5 - 10% H ₃ PO ₄	4		Irritating to skin, eyes and muc.mem.	Rinse thoroughly after skin or eye contact; eye doctor; seek fresh air after inhalation, drink plenty of water after swallowing, do not induce vomiting , physician
Phosphoric acid, 10 - 20% H ₃ PO ₄	3		Irritating to skin, eyes and muc.mem.	Rinse thoroughly after skin or eye contact; eye doctor; seek fresh air after inhalation; drink plenty of water after swallowing, do not induce vomiting , physician

CHEMICAL NAME	PC	RISK	EFFECT/SYMPTOMS	FIRST AID
Phosphoric acid , conc. >20% H ₃ PO ₄	2		Strongly irritating to skin, eyes and muc.mem.	Rinse thoroughly after skin or eye contact; eye doctor; seek fresh air after inhalation, drink plenty of water after swallowing, do not induce vomiting, physician
Potassium carbonate K ₂ CO ₃	4		Slightly irritating to skin, eyes and muc.mem.; SI-irritation after swallowing	Rinse thoroughly after skin or eye contact; drink plenty of water after swallowing, do not induce vomiting, physician
Potassium chloride KCl	5		Generally harmless	
Potassium chromate K ₂ CrO ₄	3		Carcinogen; irritating to injured skin and muc. mem.; contact sensitization possible; after swallowing stomach ache, vomiting, shock; do not breathe dust (hood, gloves!)	Rinse thoroughly after contact with skin (esp. if injured) and eyes; drink water after swallowing; induce vomiting (refer to Ch. 2); seek fresh air after inhalation; physician
Potassium dichromate K ₂ Cr ₂ O ₇	3		Dust irritating to eyes and respiratory tract (hood); forms abscesses on injured skin; carcinogen; binds to hemoglobin	Rinse thoroughly after contact with eye and esp. injured skin and wash with soap; drink water after swallowing, induce vomiting immediately (refer to Ch. 2)
Potassium dihydrogen carbonate K ₂ (HCO ₃) ₂	-		Generally harmless	
Potassium dihydrogen phosphate KH ₂ PO ₄	-		Generally harmless	
Potassium fluoride KF	3		Binds to body's calcium; chronic bone and teeth damage; irritating to skin, muc.mem. and eyes (dust; hood, gloves glasses!)	Rinse thoroughly after skin or eye contact, physician!; drink plenty of water after swallowing, do not induce vomiting, physician; seek fresh air after inhalation, physician
Potassium hexacyanoferrat (II) K ₄ (Fe(CN) ₆)·3H ₂ O	4		Develops ferrocyanide upon contact with acid and after swallowing; irritating to skin, eyes and respiratory tract	After swallowing immediately induce vomiting (refer to Ch.2); rinse thoroughly after skin or eye contact; seek fresh air after inhalation
Potassium hexacyanoferrat (III) K ₃ (Fe(CN) ₆)	4		Slightly irritating to skin and eyes	Rinse thoroughly after skin or eye contact; induce vomiting after swallowing (refer to Ch.2)

CHEMICAL NAME	PC	RISK	EFFECT/SYMPTOMS	FIRST AID
Potassium hydroxide, solid KOH	2		Very alkaline; strongly irritating to skin, muc.mem. and eyes, dust and vapors irritating to respiratory organs (hood, gloves, glasses!);	Rinse thoroughly after skin or eye contact, physician!; seek fresh air after inhalation, physician; drink plenty of water after swallowing, do not induce vomiting, physician
Potassium hydroxide, solution, > 5%; KOH	2		Strongly irritating to skin and eyes (protective gloves and glasses!)	Rinse thoroughly after skin or eye contact; remove clothes, physician; drink plenty of water after swallowing, do not induce vomiting
Potassium hydroxide, solution, 1 - 5 %; KOH	3		Irritating to skin and eyes	Rinse thoroughly after skin or eye contact; remove clothes, physician; drink plenty of water after swallowing, do not induce vomiting
Potassium iodide KI	4		Diluted solution irritating to skin and eyes, vapors irritating to respiratory tract	Rinse thoroughly after skin or eye contact; after inhalation fresh air; drink water after swallowing, do not induce vomiting
Potassium oxalate monohydrate (COOK) ₂ .H ₂ O	2		Damaging to health upon contact with skin and eyes and also swallowing	Rinse thoroughly after skin or eye contact; induce vomiting after swallowing (refer to Ch.2)
Potassium permanganate KMnO ₄	3		Strongly oxidizing; irritating and caustic to skin and eyes; after swallowing Si-irritant leading to perforation	Rinse thoroughly after skin or eye contact; eye doctor; drink plenty of water after swallowing, do not induce vomiting, physician
Potassium rhodanide KSCN	3		Damaging to health upon inhalation, swallowing and contact with skin; forms extremely poisonous gases with acids (hood!)	Rinse thoroughly after skin or eye contact; after inhalation fresh air; drink water after swallowing, induce vomiting (refer to Ch.2)
S, T, U				
Silver salts e.g. -chloride AgCl	5		AgCl generally harmless; other salts (e.g.-fluoride, -nitrate) are caustic; label; heed R-and S-phrases!	
Soda lye, < 1% NaOH	4		Slightly irritating to skin and eyes	Rinse thoroughly after skin or eye contact
Soda lye, 1 - 5 % NaOH	3		Irritating to respiratory organs, irritating to skin and eyes, protracted inflammations (gloves and glasses!); after swallowing painful SI-irritation	Rinse thoroughly after skin or eye contact; eye doctor! drink plenty of water after swallowing, do not induce vomiting !, physician; seek fresh air after inhalation

CHEMICAL NAME	PC	RISK	EFFECT/SYMPTOMS	FIRST AID
Soda lye, > 5 % NaOH	2		Causes serious caustic burns on skin, eyes and muc.mem, badly healing wounds; danger of stomach perforation after swallowing	Rinse thoroughly after skin or eye contact; wash skin with soap, eye doctor! drink plenty of water after swallowing, do not induce vomiting !, physician; seek fresh air after inhalation, physician
Sodium acetate C ₂ H ₃ NaO ₂	-		Generally harmless	
Sodium carbonate Na ₂ CO ₃	5		Strongly alkaline, irritating to eyes, skin and respiratory tract	Rinse thoroughly after skin or eye contact; drink plenty of water after swallowing, do not induce vomiting!, seek fresh air after inhalation
Sodium chloride NaCl	-		Common salt, harmless in normal amounts	
Sodium dihydrogen phosphate NaH ₂ PO ₄	-		Diluted solution generally harmless, conc. solutions cause badly healing wounds	Rinse thoroughly after skin or eye contact, wash skin with soap; drink plenty of water after swallowing, do not induce vomiting !
Sodium dichromate Na ₂ Cr ₂ O ₇	-		Irritating to eyes and respiratory tract; do not breathe dust (hood!); develops abscesses on injured skin; contact sensibility possible (gloves!)	Immediately rinse well after contact with eyes and esp. injured skin and wash with soap; induce vomiting after swallowing (refer to Ch. 2)
Sodium fluoride NaF	3		Binds to body's own calcium, bone-, teeth-damages; Irritating to skin, muc.mem. and eyes; do not breathe dust (hood, gloves, glasses!)	Rinse thoroughly after skin or eye contact; physician; drink water after swallowing, do not induce vomiting, physician; seek fresh air after inhalation; physician
Sodium formate HCOONa	5		Irritating to eyes and respiratory tract; do not breathe dust (hood!);	Rinse thoroughly after skin or eye contact; Seek fresh air after inhalation
Sodium hydrogen phosphate			Refer to Disodium hydrogenphosphate	
Sodium hydroxide, solid NaOH	2		Strongly alkaline (pH 14); extremely irritating to skin, muc.mem. and eyes; do not breathe dust and vapors (hood, gloves, glasses!)	Rinse thoroughly after skin or eye contact, physician!; seek fresh air after inhalation, physician; drink plenty of water after swallowing, do not induce vomiting , physician
Sodium hydroxide, solution			Refer to Caustic soda	
Sodium hypochloride, 5-10% actl. Cl; NaClO	4		Irritating to skin and eyes	Rinse thoroughly after skin or eye contact

CHEMICAL NAME	PC	RISK	EFFECT/SYMPTOMS	FIRST AID
Sodium hypochloride , >10% actl. Cl; NaClO	3		Irritating to skin, eyes and respiratory tract; strongly forms met-hemoglobin	Rinse thoroughly after skin or eye contact; drink plenty of water after swallowing, do not induce vomiting !, seek fresh air after inhalation, physician
Sodium nitrite NaNO ₂	2	 	Methamoglobin formation, in case of fire possible lung edema through nitrous gas	Rinse thoroughly after skin or eye contact; induce vomiting after swallowing (refer to Ch. 2)
Sodium phosphate Na ₃ PO ₄	5		Diluted solutions generally harmless, conc. solutions strong irritants	Rinse thoroughly after skin or eye contact; drink plenty of water after swallowing, do not induce vomiting !
Sodium sulfate Na ₂ SO ₄	5		Can slightly irritate SI-tract, slightly irritating to skin and eyes	Rinse thoroughly after skin or eye contact; induce vomiting after swallowing (refer to Ch. 2)
Sodium sulfide NaS	2		Strongly irritating to skin and eyes; fumes irritating to eyes and respiratory tract, poss. CNS-paralysis; with acid forms H ₂ S, with ox. agents SO ₂ formation., possible lung edema (hood!)	Rinse well upon skin or eye contact, physician!; drink plenty of water after swallowing; do not induce vomiting, physician; seek fresh air after inhalation, physician
Sodium sulfite Na ₂ SO ₃	3		Irritating to eyes, respiratory tract and esp. injured skin; nausea after swallowing	Drink water after swallowing, not induce vomiting (refer to Ch.2); rinse thoroughly after skin or eye contact, eye doctor; if dry cough physician
Sodium thiosulfate Na ₂ S ₂ O ₃	4		Irritating to eyes, skin and respiratory tract, do not breathe dust (hood!)	Rinse thoroughly after skin or eye contact; seek fresh air after inhalation
Sulfuric acid , < 1% H ₂ SO ₄	5		Irritating to eyes and skin	Rinse thoroughly after skin or eye contact; Drink water after swallowing, do not induce vomiting
Sulfuric acid , 1-3% H ₂ SO ₄	4		Irritating to eyes and skin	Rinse thoroughly after skin or eye contact; Drink water after swallowing, do not induce vomiting
Sulfuric acid , 3-10% H ₂ SO ₄	3		Strongly irritating to eyes and skin	Rinse thoroughly after skin or eye contact; eye doctor; drink water after swallowing, do not induce vomiting , physician
Sulfuric acid , 10 - 20% H ₂ SO ₄	2		Irritating to eyes, skin and muc.mem.; badly healing wounds; vapors irritate eyes and respiratory tract (hood!)	Rinse thoroughly after skin or eye contact, physician!; seek fresh air after inhalation; drink plenty of water after swallowing, do not induce vomiting , physician
Sulfuric acid , > 20% H ₂ SO ₄	2		Irritating to eyes, skin and muc.mem.; badly healing wounds; vapors irritate eyes and respiratory tract (hood!)	Rinse thoroughly after skin or eye contact, physician!; seek fresh air after inhalation; drink plenty of water after swallowing, do not induce vomiting , physician

CHEMICAL NAME	PC	RISK	EFFECT/SYMPTOMS	FIRST AID
Sulfuric acid, > 98% H ₂ SO ₄	2		Lethal dose 1 - 5 ml strongly irritating to eyes, skin and muc.mem.; badly healing wounds; vapors irritate eyes and respiratory tract (hood!)	Rinse thoroughly after skin or eye contact, physician!; seek fresh air after inhalation; drink plenty of water after swallowing, do not induce vomiting , physician
Tetrahydrofuran C ₄ H ₈ O	3		Irritating to skin, eyes and respiratory tract; narcotic, headache; removes oils from skin	Rinse thoroughly after skin or eye contact, moisturize skin; seek fresh air after inhalation; drink plenty of water after swallowing, do not induce vomiting
Tin salts, e.g.chloride SnCl ₂	2		Irritating to eyes, respiratory organs and skin (gloves, glasses, hood!)	Rinse thoroughly after skin or eye contact, seek fresh air after inhalation; drink plenty of water after swallowing, do not induce vomiting , physician
Toluol C ₆ H ₅ CH ₃	4		Strongly irritating to muc.mem.; narcotic, headache, numbness; skin resorption possible (gloves, hood!);	Seek fresh air after inhalation; drink plenty of water after swallowing, do not induce vomiting ; rinse thoroughly after skin or eye contact
Tripotassium phosphate K ₃ PO ₄	-		Generally harmless	
TRIS-buffer NH ₂ C (CH ₂ OH) ₃	-		Generally harmless	
Urea NH ₂ CONH ₂	5		Natural byproduct of amino compounds in body, generally harmless	
W, X, Z				
Xylol C ₈ H ₁₀	3		Irritating to muc.mem.; with chronic low dose headache, SI irritant; in higher conc. narcotic, damaging to CNS,	Seek fresh air after inhalation; drink plenty of water after swallowing, do not induce vomiting ; rinse thoroughly after skin or eye contact, physician!
Zinc salts, e.g. chloride ZnCl ₂	3		Caustic to eyes and skin (gloves, safety glasses!)	Rinse thoroughly after skin or eye contact; drink plenty of water after swallowing, do not induce vomiting, physician

References:

Fluka; Chemika-BioChemika: Katalog 1995/96; Fluka Chemie AG; Buchs; 1995

Kühn; Birett: Merkblätter Gefährliche Arbeitsstoffe; Band 5 und 6, ecomed; Landsberg/Lech; Loseblattsammlung ab 1975

Merck & Co., Inc.: The Merck Index; An Encyclopedia of Chemicals, Drugs and Biochemicals; 10th Edition; Merck & Co., Inc.; Rahway, USA; 1983

Roth; Daunderer: Giftliste; Giftige, gesundheitsschädliche, reizende und krebserzeugende Stoffe; Band 1 und 4; 5. Auflage; ecomed; Landsberg/Lech; 1981

3.5 Disposal of Chemicals

The best disposal is to avoid the creation of waste (e.g., through bulk ordering, recycling, etc.)!

3.5.1 Main Waste Disposal Station

Hönggerberg

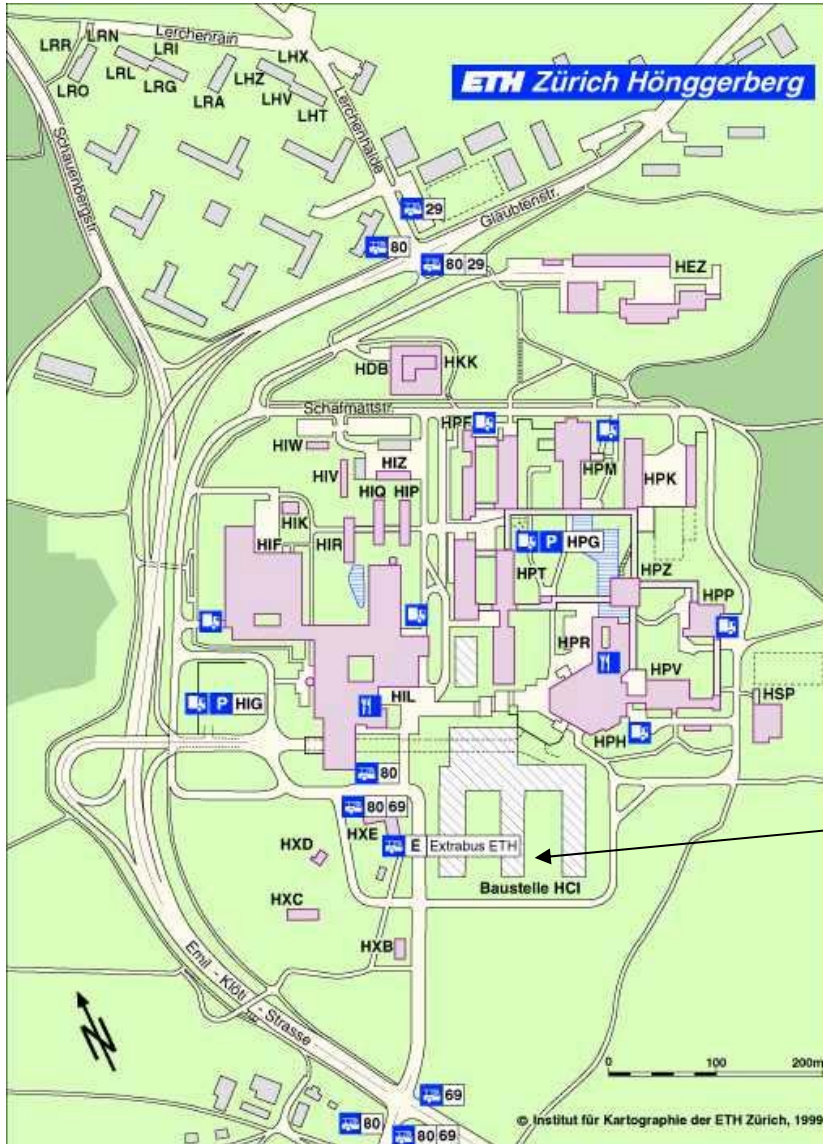

Disposal station location:
HPK D 88/89

Open:

Tuesday 0900-1100

(Please refer to the website,
www.sicherheit.ethz.ch
for actual opening hours.)

Disposal station location:
HCI D 276

Open:

Mon. – Fri. 1400-1600

(Please refer to the website,
www.sicherheit.ethz.ch
for actual opening hours.)

Our department is available for special transportation and disposal of goods outside official opening times. Appointments should be made in advance.

Apply at the e-mail address:

disposal@su.ethz.ch

Main Campus

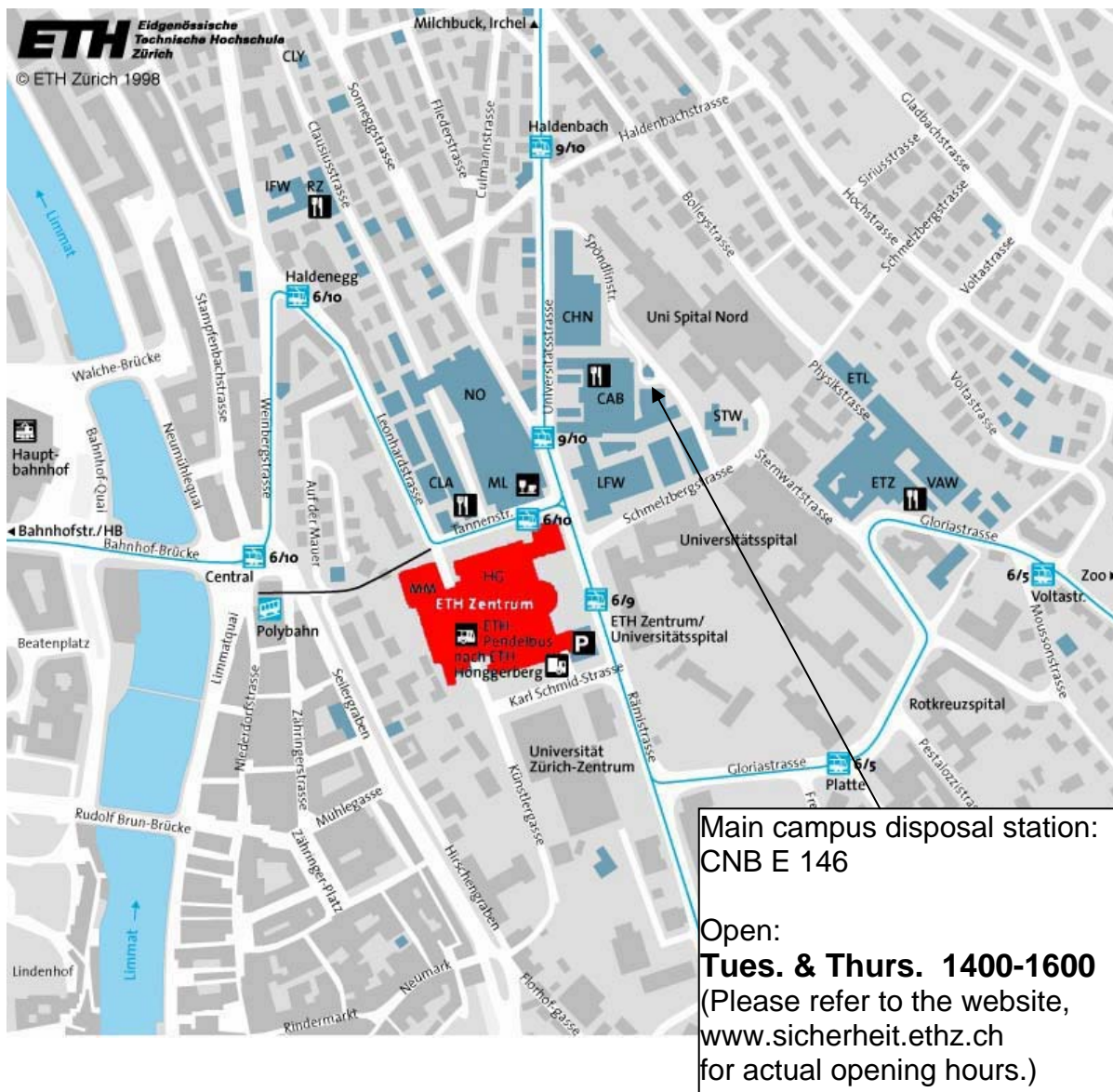

- ➔ All deposited containers should be marked with:
 - name of substance
 - responsible persons
 - internal phone number
- ➔ Please do not stuff foreign materials in bottles containing solvents. They block the pump of the disposal installation.
- ➔ **Do not leave chemicals in front of the station outside of opening hours!**
- ➔ **Collection containers** are available for use (besides the normal sacks):
 - for liquid waste: 10-, 20- and 60-liter canisters
 - for solid waste: 30-liter containers
 - for batteries: special small boxes

3.5.2 Organic Chemicals

Description	Remarks	Disposal
org. solvents common	Chlorinated and unchlorinated separated as a rule (1 - 2% chlorinated org. soln. is tolerated). Smaller amounts of chlorinated org. solutions are not worthwhile to separate. Aqueous solutions must be neutral.	collection container yellow = chlorinated neutral = unchlorinated
org. solvents with metal compounds	As a rule, chlorinated and unchlorinated are separated	collection container org. solutions
liquid Ether	Into normal solutions, if they do not contain peroxide (peroxide test Merckoquant 10011). Otherwise, hand in the original bottle with a warning indicating peroxide content. <i>Do not even try to open old ether bottles!</i>	collection container or disposal station
scintillation vials	Toluene in plastic flasks Radioisotopes: except for ^3H , ^{14}C and ^{35}S	collection container
used oil	Small amounts	collection box org. solutions unchlor.
	Large amounts	separate collection box
water-oil-emulsion		collection container
solid hydrocarbons, alcohol, ketone, ester ($\text{C}_x\text{H}_y\text{O}_z$)	Pack separately in carton, paper or plastic (polyethylene).	normal garbage
explosive materials that explode upon impact, e.g., friction	e.g.. organic perchlorate, certain azo-, nitro-compounds, peroxide (Consider warning on label.)	inquire at safety@su.ethz.ch
gases	Return bottles before time of expiration! Release remaining pressure (ca. 2 - 10 bar) Obtain gas only from firms that accept bottles with contents.	chemical desk or distributor (in case return is not possible -> disposal station)
other chemicals (incl. non-explosive metal-organic compounds)	Pack separately in bottles with maximum 1-liter capacity. <i>Especially mark mutagenic and carcinogenic materials (Follow instructions on label)!</i>	disposal center

3.5.3 Inorganic Chemicals

1. Metal salt solutions

Description	Remarks	Disposal
all < 0,1 M	<i>no</i> heavy metal (esp. mercury, chrome, cadmium, lead) and <i>no</i> precious metals, <i>no</i> complexing agent introduce under cold running water	canalization
acid	<i>no</i> mercury, arsenic, cyanide, fluoride, sulfide or complexing agent	collection container
alkaline	<i>no</i> ammonia, mercury; arsenic, cyanide or complexing agent	collection container
ammonia-containing	<i>no</i> mercury, arsenic or complexing agent	collection container
cyanide-containing	<i>no</i> mercury, arsenic or complexing agent Solutions must be alkaline.	collection container
mercury-containing	<i>no</i> complexing agent	collection container
arsenic-containing	<i>no</i> complexing agent, solutions must be alkaline.	collection container
selene-, antimony-, thallium-containing	<i>no</i> complexing agent, solutions must be alkaline.	to the arsenic container
with stable metal complexes	e.g., with EDTA-complexes <i>no</i> mercury, arsenic or cyanide	collection container
Kjeldahl solutions	with mercury catalyst	collection container

2. Acids

Description	Remarks	Disposal
chromosulfuric acid		collection container
hydrofluoric acid	poison class 1; handle only with special gloves and face protection.	collection container
conc. hydrochloric acid	work only with gloves and eye protection	collection container
conc. sulfuric acid	work only with gloves and eye protection	collection container
other conc. acids	collect separately	collection container
nitrohydrochloric acid	dilute to 35%	collection container
rest until 0,1 M	neutralize if possible, mix with water, introduce under cold running water	canalization

3. Bases

Description	Remarks	Disposal
concentrated	Collect separately. Use eye shields and gloves when handling.	collection container
until 0,1 M	If possible neutralize, mix with water. Introduce under cold running water.	canalization

4. Explosive, flammable or oxidizing that develop explosive gases with water**EMERGENCY : 888**

Description	Remarks	Disposal
phosphorous	Fill in glass bottles under water.	disposal station
metals	Fill in glass bottles or white tin cans under paraffin oil.	disposal station
alkali amides	Fill in glass bottles under toluene.	disposal station
hydrogen peroxide	Dilute strongly; introduce under cold running water.	canalization
oxidizing materials	e.g., certain acetylide, azide, chlorate, fulminate, hydride, nitrate, nitrite, perchlorate, peroxide and perchloric acid Pack appropriately.	Waste disposal station
explosive materials	e.g., certain acetylide, azide, chlorate, fulminate, hydride, nitrate, nitrite, perchlorate, peroxide and perchloric acid Pack appropriately.	Waste disposal station- Inquire beforehand at: safety@su.ethz.ch

5. Others

Description	Remarks	Disposal
photographic fixation solution		collection container
photographic developing solution		collection container
film		disposal station
gases	Return gas flasks before the storage expiration date! Release remaining pressure in bottle (ca. 2 - 10 bar) Only use companies that accept bottles with contents.	chemical counter or distributor (in case return in not possible -> disposal station)
other chemicals	Solid salt, materials that develop acidic bases, etc. Pack separately	disposal station
used glass	Separation by color, not necessary For glasses without solid remains, rinse once with water, remove lid, label must not be removed.	collection container

Continued (5. Others)

Description	Remarks	Disposal
mercury batteries	collect separately	recycling container
other batteries		recycling container
plastic	<i>Only collect PVC, polystyrene and PET separately; dispose rest in normal garbage</i>	recycling container or household garbage
aluminum, iron, steel	collect separately Separate aluminum drinking cans from other aluminum (recyclable)	recycling container or disposal station
carton	Clean and free of plastics and other foreign material, staples are tolerated	recycling container
paper	Clean and free of plastics and other foreign material, staples are tolerated	recycling container

3.5.4 Spilled Chemicals

Many **slightly volatile compounds** (mostly solvents), upon contact with air, develop **explosive mixtures** that accumulate on the ground because they are heavier than air. Avoid open flames and ventilate immediately! Unscrew safety valve (phone for help only when outside of the area containing explosive mixture!).

With mixtures that develop **highly toxic or caustic vapors** or **toxic dust**: block off the area, call tel. (63) 22169 / 22161 / 26887.

EMERGENCY : 888
1. Gases**→ compressed gas bottles with small leak**

Place under the fume hood; call tel. (63) 26535 / 23095

→ compressed gas bottles with large leak

Block off area if toxic, flammable, or oxidizing. Alert Abt. S+U in every case:

EMERGENCY : 888

Also alert **fire dept 0-118**

2. Explosive, flammable or oxidizing materials that develop flammable gas when combined with water

Avoid open flames. Unscrew safety valve only when it is not in contact with inflammable, oxidizing materials. Never turn off devices immediately (sparks!).

→ Phosphorus

Cover with wet sand and scoop into a container with water.

→ Alkali metal

Block off area. Wait at a safe distance if a reaction with surrounding water follows. If not, cover alkali metal with sand and scoop into container with paraffin oil.

Wear eye protection and gloves! Do not touch with bare hands under any circumstances!

→ Others

e.g., certain acetylide, azo-compounds, azide, chlorate, fulminate, hydride, nitrite, nitro-compounds, perchlorate and perchloric acid

Block off area. Call tel. (63) 22169 / 22161 / 26887

EMERGENCY : 888

3. Other solid substances

→ Wipe off. Further handling according to pages 27 to 29.

4. Liquids

→ Aqueous

Neutralize, wipe up. Further handling according to pages 27 to 29.

→ Organic

Take up with suitable binding agent (for non-toxic liquids e.g., paper, wooden chips, otherwise, vermiculite and oil binders)

- **Carbon disulfide:** hand over together with the binding material with water overlay.
- **All others:** pack binding material with absorbent compounds in plastic and hand in.

5. Mercury

Aspirate with pipette (**use pipetting aid, never with the mouth**). Take up the rest with the so-called, "mercury spoon" or first bind with tin dust, bind with iodine or flower of sulfur.

4. WORKING WITH ELECTRICITY

In this chapter you receive instructions in handling low-voltage electricity (50 - 1000 volt) and also correct conduct when working with high voltage electricity (over 1000 volt). Weak current (< 50 volt, < 2 A), that is used, for example, for surveys is considered harmless. With small voltages (< 50 volt) the fire risk, above all, should be considered. In most cases, they are not considered lethal to humans. Behavior in case of accidents with electricity is mentioned in Chapter 2.

First some general remarks about electricity:

Normally, with the isolation of electrical devices, the human body is prevented from coming directly into contact with the flow of electricity. However, incorrect isolation or inappropriate handling of electrical installations can lead to an electrical circuit, which can be closed by the human body. There are three frequent ways of current to flow (see below).

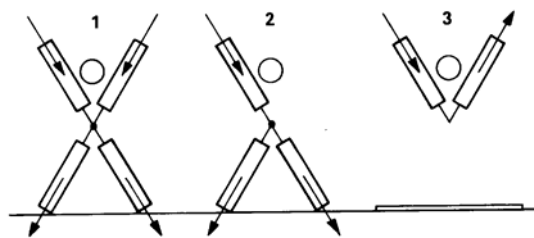

1 Hands - Feet (resistance approx. 550 Ohm)

2 Hand - Feet (resistance approx. 750 Ohm)

3 Hand - Hand with isolated ground (resistance approx. 1000 Ohm)

Fig. 4.1: The three most frequent flow of current through humans. from: SBA Nr. 135, SUVA

The resistance of the body depends on the electrical path, the humidity of the skin and the articles of clothing, floors, and footwear among other things. The values given above are, therefore, only estimations. In Switzerland, for the calculation of electrical shock, a body resistance of 1000 ohms is calculated.

The human body can be damaged directly, on one hand, by flowing current. In particular, if the heart lies in the conducting path (1 and 3, see also table 4.1). On the other hand, smaller currents can also frequently lead to indirect damages, as when a person frightened by an electrical impact, falls off a chair or stool.

With current flow over the body by an electric circuit it applies that the current, I , becomes stronger, the larger the voltage, U , and the smaller the resistance, R , that is,

$$I = \frac{U}{R} \text{ [ampere]}$$

Decisive for the effect of the current on the body is the current intensity, I , and the impact time. For example a potential of 220 V and a flow from the hands to the feet (resistance about 550 ohms) creates a current of:

$$I = \frac{220 \text{ Volt}}{550 \text{ Ohm}} = 0.4 \text{ ampere} = 400 \text{ milliampere}$$

Since electric current stimulates muscles it has flowed through to contract, it usually causes strong muscle cramping if the current flow is not interrupted. This becomes a problem, in particular, with the respiratory muscles that are stilled. With the heart muscle, whose function is based on electro-chemical procedures, external acting current can lead to heart ventricular fibrillations (irregular, cramp-like contractions of individual muscle fibers), whereby blood transport is practically interrupted and the victim is in a state of mortal danger. Already a current of 400 milliamperes (see above) can release such heart ventricular fibrillations. If the current flow manages to break through before the lapse of a heart period (approx. 0.8 seconds) high current can then be withstood without larger damage.

In the following table the possible effects of electric shock are represented according to current amperage and reaction time (threshold values):

Current	Effects of current
0,05 mA	tingle, perceptible with tongue
1 mA	tingle, perceptible with finger
1 to 15 mA	increased tingle, finally start of muscle cramps
15 to 20 mA	“let go” range (hand cannot be removed from grasped conductor anymore)
20 to 50 mA	increasing muscle cramps, difficulty in breathing, respirator arrest and in 3 to 4 minutes asphyxiation (in case current flow is not interrupted)
50 mA	ventricular fibrillation after a few seconds possible; death (flicker threshold)
over 50 mA	ventricular fibrillation in (fractions of) seconds; death
over 3 A	severe burns; death

Table 4.1: Possible effects of electric shock. From: SBA Nr. 135, SUVA

In addition, the current flow has thermal effects. With small entry surfaces (e.g., small wires) already currents of 220 V can lead to burns, which can reach deep in the skin and develop into focal infections. Large burn wounds are even life threatening due to the associated ample loss of liquid. Particularly during longer action of direct current, comes the danger of blood decomposition.

These examples show that in handling relatively deep voltages and current, certain caution is necessary. The following instructions should, therefore, be followed when handling technical devices!

4.1 **General Conduct**

- Immediately report any **defects on the cable, plug or apparatus** for repairs to a supervisor. You should not try, under any circumstances, to repair a defect provisionally (insulating tape, etc.).
- Only **expert personnel** (operations electricians, house servicemen) may implement **installations** in the house net.
- Electrical equipment may not be placed within range of **splashing water**.
- **Never bypass or change protective devices** (fuses, safety switch, etc).
- Apparatus that cannot be grounded for instrumentation reasons must be secured by enough isolating transformers or circuit breakers.
- Use plastics or ceramics for **insulation**; cardboard and wood are principally unsuitable for this purpose.
- **Disconnect** electrical devices **from the electrical source** before any manipulation.
- For **high voltage systems**, do not use banana plugs and extension cords with reciprocal plugs. Blank wires and crosspieces, which impair the effectiveness of protective grounding, are dangerous!
- Make certain when laying out **extension cords** that nobody can stumble over them (if necessary, tape to affix). For permanent installations, the extension cord may not be longer than 5 meters. Extension cord **rolls** must be **completely unrolled** before operations, in particular if high performance devices are connected. (Rolled-up cables are fire risks because of increased resistance).
- When using **altered devices and plugs** (esp. untested ones), it should be clarified whether suitable security is available (in the ideal case, FI-switch). Speak with responsible personnel to clear any uncertainties.
- Always get expert help if you are in doubt about whether the equipment to be used is properly installed and functional.

4.2 **Behavior in Case of Accidents**

Refer to Chapter 2.

4.3 **Disposal Considerations**

Refer to Chapter 3.5.

4.4 Working with High Voltage

This section deals particularly with the use of high voltage for experimental purposes as for example, in the high voltage laboratory. It should not be forgotten, however, that **many devices, which must deliver high performance of any kind, must also be operated with high voltage.** This applies e.g., to all lasers of the class 4, to NMR devices, and to electron microscopes. **The following applies to all these devices:**

- **Before each manipulation** for which the housing must be opened, the equipment should be **removed** absolutely from the **current supply**.
- In case the fuse is to be unscrewed, a **warning card** should be attached to the fuse box so that no one inadvertently screws in the fuse too early!

Areas where one works with high voltage and devices that are operated with high voltage are marked by this danger warning:



Hochspannung
Lebensgefahr

4.4.1 General Facts

- Consider for all low-voltage circuits (220 V) the instructions in Chapter 4.1.
- Inform yourself before you begin with setting up an experiment, about **proper behavior in case of accidents** with electricity (see Chapter 2).
- Inform yourself before the execution of **experiments with gases** about their properties and potential dangers (see Chapter 7.2). Also bear in mind that during the experiment that other (possibly toxic) compounds could develop.
- Regard each experimental test set up, which **is not visibly grounded** (grounding bar), as standing under tension. Simply getting close can be lethal!
- Use the red **emergency switches only in case of an accident** (it immediately disconnects the whole laboratory supply and sets off an alarm by the technical staff, so that rapid assistance is ensured).

4.4.2 Experimental Setup

- High voltage outlet parts may be found **only within the enclosed experimental field**. They are to be secured and constructed in such a way that no danger can exist outside of the experimental field.
- The **entrance** to the experimental field is to be secured with fences and a blocking door.

- The supports of the grounding rod(s) and all stopper grids and doors must be within the **safety area**.
- **Before the first running of the testing equipment**, the function of the safety circuit must be examined beforehand.
- When making **big changes** to the testing equipment, reexamine the security inside and outside of the experimental field.

4.4.3 Operation

- Do not use the safety switch for routine switching off of the testing equipment.
- **Before entering** the experimental field, make sure that:
 - all sources of **high voltage** are switched off.
 - the high voltage circuit has reliable contacts and stays **grounded** with the grounding rod.
 - all **condensers** in the experimental field are unloaded and grounded, especially with direct and alternating current experiments.
- Check **before switching on** the high voltage testing equipment if:
 - **all persons have left the experimental field.**
 - **the grounding bar has been removed and hung up at its intended place.**
 - **the entrance to the experimental field has been closed off with the blocking door.**
- If there is **any uncertainty whatsoever**, seek expert advice (e.g., specialized group: high voltage technology).

4.4.4 Disposal Considerations

Also refer to Chapter 3.5.

- Take heed when performing experiments with gas for **proper elimination of waste products**. Pay special attention when dismantling the apparatus that no gases escape into the lab atmosphere.

References:

Schweizerische Blätter für Arbeitssicherheit (SBA), Nr. 103: Die Fehlerstromschutzschaltung; SUVA; Lucern; 1990
Homburger, E.: Die Gefahren der Elektrizität; SBA Nr. 135; SUVA; Lucern; 1988

5. WORKING WITH RADIOACTIVE MATERIALS

Radioactive materials are understood as substances, which send ionizing radiation through spontaneous decay of their atomic nuclei. This radiation is again in the position to produce by splitting off from electrons or by fragmentation of atoms or molecules ions. The radioactive materials you come in contact with at ETHZ comes the form of **“open” or “sealed” sources**.

“Open” is understood as sources, which contain materials that can escape and thus, cause contamination. Typical isotopes are hydrogen-3 (tritium), carbon-14, phosphorus-32 or sulfur-35. They are used for example, as markers in biochemistry. With all open sources, the danger of incorporation exists, e.g., by inhalation of contaminated air.

Sources are **“sealed”** if, by their design, escape of radioactive materials under normal working conditions is impossible. They are used particularly in the measurement and control engineering and in medicine (for example, cobalt-60, strontium-90). X-ray machines are another type of sealed sources. They are used, in particular, for structural analysis and material testing. With sealed sources, the major danger is of external irradiation in case the equipment is not sufficiently shielded or used inappropriately.

Except for sealed sources such as x-ray units, which intentionally produce ionizing radiation, **devices that are operated with high voltage, such as electron microscopes, can form (unintended) ionizing radiation**. The radiation can come from particles of high energy that are stopped, for example, in the interior of the equipment. Normally this radiation is shielded by the equipment lining. Nevertheless, a certain caution is required in handling such devices with regards to their radioactive emissions. For example, linings should not be removed or flanges themselves must be replaced.

The average annual radiation dose from natural sources in Switzerland amounts to about 3.5 mSv (the unit, “Sievert“ stands for the equivalence dose, i.e. the absorbed dose multiplied by the valuation factor of the particular type of radioactivity; determinant for damages), whereby, radon has the largest presence in dwellings. The average emission from artificial sources amounts to about 1.4 mSv, whereby medical applications should be noted.

The **effects of ionizing radiation** on the body are dependent on the dose and above all, the effective period. For example, a whole-body dose of 5 Sv is deadly when accumulated within a few seconds but when slowly applied over weeks shows no tangible, clinical effect.

With acute surface irradiation starting from short time doses of approximately 0.5 Sv and above, non-stochastic radiation damage (i.e. for each person irradiated with this dose, dose-dependent) is to be expected. Purely external radiation results, thereby, to damage of the skin and possibly the underlying tissue. After a latency of days or weeks, follow inflammation reactions and necroses. Acute whole-body irradiation from 0.5 to 1 Sv upwards results in the so-called, “radiation sickness” (nausea, later skin damage, hair loss, typical chromosomal mutations, etc.).

After incorporation, in principle, the same acute damage is to be expected, whereby individual substances are often accumulated in certain tissues (e.g., iodine-125 in the thyroid). The biological half-life varies, therefore, between a few hours and several decades.

With the chronic load of the body with ionizing radiation, the cancer risk and the danger of genetic damage are to be considered primarily. It is crucial here that for these damages no threshold dose is known!

Preventative measures are, therefore, necessary when working with radioactive materials, which are described in the following. In addition, you will find instructions for the correct behavior in accidents and for waste disposal.

5.1 General Conduct

5.1.1 General Principles

- Do not work with radioactive materials **without proper training** from an experienced person.
- **Never work alone**, if possible, in an isotope laboratory.
- Work in such a way that **any contamination** of hood, walls, floor, work clothes, tools etc., **does not happen**.
- Should a **contamination** occur, **promptly report** incident to the institute radiation safety officer.
- **Food and drinks** may not be stored or consumed in the laboratory.
- **Smoking** is generally forbidden in the laboratory.
- **Do not blow your nose in the lab**. Otherwise, radioactive substances may reach your face or nose through possibly contaminated gloves.
- **Do not use cosmetics** (esp. moisturizing creams) in the lab. The liposomes they contain could transport radioactive substances into the skin.
- With the use of radioactive materials that cannot be burned, plan ahead in order to keep the quantity of the **produced waste** to a **minimum**. However, waste avoidance should not be done at expense of work safety (e.g., continuing to work with contaminated gloves to avoid producing waste).
- **Nothing** may be **brought out** of the **secure zone** without first being **checked** for radioactivity.

5.1.2 Work Clothing

- When working in the isotope lab, always wear gloves and a special **lab coat**.
- Wear **gloves** when working with open sources (disposable PVC or PE gloves, latex examination gloves).

5.1.3 Working Place

- At the working place the following should be within **easy reach**:
 - sufficient quantity of gloves (see above)
 - Kleenex
 - waste container
 - contamination monitor (except for work with ^3H).
- In principle, work with open sources should be done under the hood.
- Work on a clearly defined place, with absorbent material (e.g., Benchcote) laid over tanks made from high-grade steel or PVC.
- Always immediately mark all containers, particularly those with radioactive contents:
 - type of nuclide
 - activity
 - name of responsible persons.

This applies particularly to containers that are stored in generally accessible refrigerators and freezers. Use water-resistant felt-tip or ballpoint pens for writing.

- The **house vacuum** may not be used. Use the water-jet pump with a vacuum controller.
- **Avoid**, if possible, the use of **syringes and cannulas** (danger of injury or contamination).
- **Wash off** instruments only outside of the hood. Only use basins whose wastewater is monitored before entering the canalization.
- Do **not** bring **office materials** into a laboratory, which works with open sources.
- With work that lasts longer than 24 hours, a sign should be placed on the hood.

5.2 Properties of Important Isotopes

Explanations:

- unit bequerel (Bq): measurement of activity, i.e. the number of radioactive decay per time unit. Still often used is the historical unit curie ($1 \text{ Ci} = 3.7 \cdot 10^{10} \text{ Bq}$).
- The contamination dose refers to the amount of energy taken up by bare skin.
- The subsequent dose, E50, designates the average dose that one receives after the incorporation of a certain activity before the substance decays or is discharged.

5.2.1 Iodine-125

Type of the radiation	γ - radiation
Decay	$\text{I-125} \rightarrow \text{Te-125} + \text{photon} + \text{energy (max. 0.000035 MeV)}$
Range in air	practically unlimited
Range in water or plexiglass	practically unlimited
Range in lead	0.01 cm lead reduces radiation to 10% of the initial value
Radioactive half-life	59.6 days
Direct dose	9.25 MBq, 1 cm distance $\rightarrow 50 \mu\text{Sv/h}$
Contamination dose	9.25 MBq, $100 \text{ cm}^2 \rightarrow 0.15 \text{ mSv/min}$
Subsequent dose E50	9.25 MBq, incorporated $\rightarrow 157 \text{ mSv}$
Characteristics	Accumulates in thyroid, long biological half-life (40 days). Use special caution in handling! Give iodide tablet immediately upon incorporation.

5.2.2 Carbon-14

Type of the radiation	β -radiation
Decay	$\text{C-14} \rightarrow \text{N-14} + \text{electron} + \text{antineutrino} + \text{energy (max. 0.157 MeV)}$
Range in air	centimeter range
Range in water or Plexiglas	millimeter range
Radioactive half-life	5730 years
Direct dose	9.25 MBq, no Plexiglas, 10 cm distance $\rightarrow 31 \mu\text{Sv/min}$
	9.25 MBq, Plexiglas $\rightarrow < 0.1 \mu\text{Sv/h}$
Contamination dose	9.25 MBq, $100 \text{ cm}^2 \rightarrow 0.5 \text{ mSv/min}$
Subsequent dose E50	9.25 MBq, incorporated $\rightarrow 5.2 \text{ mSv}$
Characteristics	Biological properties similar to sulfur-35

5.2.3 Phosphorus-32

Type of the radiation	β -radiation
Decay	P-32 \rightarrow S-32 + electron + antineutrino + energy (max. 1.7 MeV)
Range in air	meter range
Range in water or Plexiglas	1 to 10 mm
Radioactive half-life	14,29 days
Direct dose	9.25 MBq, Plexiglas, 1 cm distance \rightarrow 0.8 μ Sv/min 9.25 MBq, Plexiglas, 50 cm distance \rightarrow 0.0003 μ Sv/min
Contamination dose	9.25 MBq, 100 cm ² \rightarrow 2.5 mSv/min
Subsequent dose E50	9.25 MBq, incorporated \rightarrow 23 mSv

5.2.4 Sulfur-35

Type of the radiation	β -radiation
Decay	S-35 \rightarrow Cl-35 + electron + antineutrino + energy (max. 0.167 MeV)
Range in air	centimeter range
Range in water or Plexiglas	millimeter range
Radioactive half-life	87.4 days
Direct dose	9.25 MBq, no Plexiglas, 10 cm distance \rightarrow 31 μ Sv/min 9.25 MBq, Plexiglas \rightarrow < 0.1 μ Sv/h
Contamination dose	9.25 MBq, 100 cm ² \rightarrow 0.5 mSv/min
Subsequent dose E50	9.25 MBq, incorporated \rightarrow 2.6 mSv
Characteristics	Due to minimal radiation energy, emitted radiation is mostly blocked by rubber gloves. Instead contamination and incorporation are dangerous. With accumulated incorporation, higher doses with long t _{1/2} . Sulfur compounds (esp. TRAN35-S) are often volatile!

5.2.5 Tritium (Hydrogen-3)

Type of the radiation	β -radiation
Decay	H-3 \rightarrow He-3 + electron + antineutrino + energy (max. 0.000018 MeV)
Range in air	millimeter range
Range in water or Plexiglas	micrometer range
Radioactive half-life	12,4 years
Direct dose	9.25 MBq, no Plexiglas, 10 cm distance \rightarrow < 0.1 μ Sv/h
Contamination dose	9.25 MBq, 100 cm ² \rightarrow < 0.1 μ Sv/h
Subsequent dose E50	9.25 MBq, incorporated \rightarrow 37 mSv
Characteristics	Tritium-radiation is not detectable with conventional monitors. Damaging upon incorporation (detected though urine test).

5.3 Behavior in Case of Accidents

→ **Stay calm. Do not move around** (further contamination), **do not leave secure zone for any reason.** (Exception: fire: leave lab, close door, stay in front of the room!)

→ **First aid:**

- **Contamination of intact skin:**

A quick reaction is important! Using caution, immediately remove contaminated gloves (dispose) and lab coat, as well as contaminated clothes (plastic bag). Wipe off contamination with a tissue and wash thoroughly with soap and water. If necessary, the upper layer of hard skin may be scraped off using proper instruments (do not create open wounds!). Take care that a further secondary skin surface is not contaminated! See physician for further treatment.

- **Contamination of wounds:**

Also here, a quick reaction is important. If possible, induce self-cleaning of the wound through forced bleeding (pressure or tying of rubber hose). Take care that a further secondary skin surface is not contaminated! See physician for further treatment.

- **Incorporation:**

If available in lab, immediately administer specific antidote (decorporation agent) to reduce the effect on the intended organ (i.e. potassium iodide with iodine-125). Find out the name, approximate amount of isotope, method and time point of incorporation. See physician for further treatment.

→ **Call:**

1. **Radiation safety officer** of the institute
2. Dept. SHE (**tel. 888**)

Inform yourself of your actual location, the kind of accident, and the injury, as well as the nuclide used.

5.4 Disposal Considerations

($t_{1/2}$ = half-life)

1. Solid Waste

Radioactive symbol must be made unrecognizable.

Description	Remarks	Disposal
$t_{1/2} < 60$ days	<i>including</i> sulfur- 35 ($t_{1/2}$ 87,5 days) collect separately, label clearly and permanently: nuclide, date of filling, responsible persons	collection container, decay facility
Type 1	Ra-226, Ra-228	collection container
Type 2	all α -emitter <i>except for</i> Ra-226, Ra-228	collection container
Type 3	H-3 and C-14	collection container
Type 4	nuclide with $t_{1/2} > 60$ days <i>except for</i> α -emitter and H-3, C-14	collection container
Type 5	neutron sources	collection container

2. Liquid wastes

Never pour into drain!

Dilution of active waste, in order to release to the outside, is highly forbidden and subject to fines!

Separate according to isotope in labeled PVC-bottles in the hood or collect in 10-liter-canisters.

C-14 waste: add 0.05% sodium azide (possible formation of $^{14}\text{CO}_2$)

Dispose through specialized personnel.

References:

Weickhardt, U.: Ionisierende Strahlen. Schweizerische Unfallversicherungsgesellschaft (SUVA); Abteilung Arbeitsmedizin; Nr. 4; Lucern; 1992

6. WORKING WITH STRONG MAGNETIC FIELDS

Strong magnetic fields are used, for example, in NMR tests (= Nuclear Magnetic Resonance), in order to identify materials or examine chemical structures. It takes advantage of the reciprocal effect of magnetic atomic nuclei with external magnetic fields. Magnetic fields also develop in radiographic electron microscopes. The lenses of these microscopes have electromagnetic coils that are supplied with high voltage. Between the coils a magnetic field forms. Since this magnetic field is sufficiently shielded under normal conditions to prevent being a threat to people, **this chapter concentrates only on NMR work.**

NMR devices produce, on the one hand, a very strong homogeneous magnetic field and, on the other hand, a high frequency magnetic alternating radio wave. In work with NMR, the safety boundaries of the homogeneous magnetic field are relevant since the radio field is well shielded. Bear in mind that the pulling power of the coils decrease according to the ratio, $1/r^2$, i.e. the closer one approaches with the magnet towards a metallic object, the stronger is the attraction. Thus, particularly, if a heavy object like a compressed gas bottle is placed in motion towards a magnet, it can be hardly brought to the stop. Therefore, some warnings must be obeyed in order to avoid, on one hand, injuries and, on the other hand, expensive damage to the equipment.

Health effects of longer exposure to strong magnetic fields on the human body are controversially discussed. A clear working mechanism could not be proven so far.

For questions concerning behavior in case of accidents, refer to Chapter 2.

6.1 General Conduct

- Wearers of **cardiac pacemakers** (especially older models) are particularly endangered. The function of the pacesetter can be impaired or even interrupted. Consult a physician before work with NMR.

Safety margins:

- devices with frequencies up to 500 MHz: 5 meters
- devices with frequencies from 500 - 800 MHz: 8 meters

These distances apply both in horizontal **and in vertical direction**, thus, also rooms that are over or under a room with NMR equipment. This **warning sign** marks all areas concerned:



- Wearers of **metallic prostheses** or persons, which have not had **metal screws or plates** removed after an operation must, before working on NMR equipment, confirm whether the metal parts react magnetically. If it is, the **safe distance from the NMR is 5 meters**.
- Before entering the NMR laboratory, **remove all metallic objects** (key, coins, tools etc.) from bags and put down all jewelry that could react magnetically.
- Do **not** bring **credit cards, copy cards, floppy disks, etc** to the NMR laboratory. The magnetic strips will be deleted and thus, cards or disks will be rendered useless.
- **Compressed gas bottles may not be brought** into the NMR laboratory. There exists the danger of damage to the equipment and the bottle that can lead, depending upon the gas, to injuries, fires or explosions.
- Only authorized persons may do **manipulations** of any kind to the equipment.
- Never look into the sample inlet pipe. There is danger of injury in case someone ejects a sample at the same time.
- With experiments, do not exceed temperature gradients over **the boiling and the freezing point of the sample**. Dangerous pressures can develop which can cause the sample tube to burst.
- The interior of NMR machines contains liquid inert gas. If the super conduction in the equipment for any reason is waived, the gas escapes through the release valve upward into the laboratory atmosphere (so-called "**Quench**"; loud hissing, visible gas fog over the equipment). The gas is usually harmless; however, it displaces the breathing air in the area, creating the danger of suffocation. In addition, there exists with all liquid gases, due to their low temperature, the danger of burn-like injuries upon skin contact.
 - Immediately leave the room, close the door.
 - Upon prolonged skin or eye contact immediately wash thoroughly with cold water. Treat like a burn (refer to Chapter 2).
 - Inform responsible persons.
 - Enter room only after the unknown gas has been cleared from the room.

6.2 Behavior in Case of Accidents

Refer to Chapter 2.

6.3 Disposal Considerations

Refer to Chapter 3.5.

7. HANDLING OF COMPRESSED GAS BOTTLES AND GAS

The following incident shows that anything can happen with the inappropriate treatment of compressed gas bottles:

Six carbon dioxide bottles, components of a fire extinguishing system, had been removed from their fixed location on the walls so that painters could paint the wall unhindered. As the cylinders were being reinstalled, they noticed that one of them was leaking. One of the painters took it over his shoulder and tried to drag it over the floor. At this moment the cylinder valve shot out, and the cylinder became a jet-driven, 100-kilo iron projectile. The painter held the cylinder to the ground, but he could not hold on to it for long. The cylinder raced across the ground, struck another cylinder and bent its valve. Then it turned and after approximately 6 meters, struck the ladder of a painter who then fell down. After spinning several times, the cylinder shot against a wall. Again it turned, crossed the area and pursued an electrician. After approximately 12 meters it struck the wall again and broke off four bricks. After renewed turning, it again pursued the electrician through an open door. The electrician brought himself to safety by escaping through a side door, at which time the cylinder shot a further 20 meters straight ahead. Finally it fell into a pit, where the remaining gas could leak out without causing further damage.

This incident, from a distance, seems extremely amusing for those not present but surely not for those that were. It shows clearly the dangers of gas bottles with compressed contents. After shooting off the valve, a gas bottle can go on a free flight of about 800 meters or pierce concrete walls of approximately 20 cm thickness. Heeding the following general instructions regarding the handling of compressed gas bottles protects you quite reliably from such incidents.

Gas cylinders are themselves not only a danger physically but also their actual contents, the gases, can be flammable, explosive or toxic. At the end, the frequently used gases, their possible dangers, and the necessary safety precautions will be described. For questions regarding waste disposal see Chapter 3.5.

7.1 General Facts

Compressed gas bottles contain gases in compressed or liquefied condition (see Table 7.1). The filling pressure of compressed gases amounts to normally 200 bar. With liquefied gases, the filling pressure corresponds to the steam pressure of the respective connection. As temperature rise, the pressure in the compressed gas bottles rises strongly in accordance with the steam pressure equation:

$$\frac{dP}{dT} = \frac{L}{T} (V_1 - V_2)$$

p = steam pressure [bar]

T = temperature [K]

L = heat of transformation (e.g., evaporation enthalpy)

V_1 = volume in steam form or liquid condition

V_2 = volume in liquid or solid condition

7.1.1 Reception of Gas Cylinders

Upon receipt of the gas cylinders, check if the indicated names of the gases correspond with the color code of the bottle:

Name	Color code		Condition	Pressure
	new	old		
acetylene (dissolved)	oxide red	orange	gas form	15 bar
ammonia	zinc yellow	violet	liquid	8 - 10 bar
argon	emerald green	brown / green	com gas form	200 bar
butane	fire red	gray	liquid	5 - 10 bar
chlorine	yellow	yellow	liquid	6 - 8 bar
hydrochloric acid	yellow	yellow / red	liquid	60 - 80 bar
ethylene	fire red	gray	liquid	20 - 30 bar
forming gas (N ₂ /H ₂)	fire red	red / green	com gas form	200 bar
helium	olive brown	yellow / green	com gas form	200 bar
carbon dioxide	dusty gray	black	liquid	60 bar
carbon monoxide	zinc yellow	gray	com gas form	200 bar
air	yellow green	brown	com gas form	200 bar
methane	fire red	red / brown	com gas form	175 - 200 bar
propane	fire red	gray	liquid	10 - 15 bar
oxygen	pure white	blue	com gas form	200 bar
sulfur dioxide	zinc yellow	gray	liquid	5 - 10 bar
sulfur hexafluoride	yellow green	gray	liquid	17 bar
hydrogen sulfide	zinc yellow	gray	liquid	5 - 15 bar
nitrogen	deep black	green	com gas form	200 bar
nitrogen dioxide	zinc yellow	gray	liquid	10 bar
hydrogen	fire red	red	com gas form	180 - 300 bar

Table 7.1: Name, color code, condition, and cylinder pressure of selected gases

If there is a discrepancy, the bottle should be returned to the supplier immediately. Do not withdraw a sample from the cylinder to check its actual contents.

7.1.2 Transport

- Transport compressed gas bottles only with the **valve protection cap** in place.
- Always **use a cart when moving bottles**, especially if the regulator is already installed and the valve protective cap cannot be put in place. Secure the gas bottle with a fireproof chain during transport.
- **Never attempt** to roll, tow along, or drag over the ground a gas bottle (see p.49!). Avoid dropping and striking gas bottles against each other.

7.1.3 Storage

- Compressed gas bottles may be stored, over long periods of time, only in dry, well-ventilated, fireproof areas.
- The storage installations of combustible gases must be explosion-proof, and the area should be clear of any sources of heat or ignition. **The laboratory is not a suitable place for the storage of gas bottles!**
- Fittings must be in place, which **prevent the gas bottles from falling over**. It is advisable to separate the bottles according to their type (flammable, corrosive, not flammable).
- Empty and full bottles must be stored separately. Empty bottles should be clearly marked (e.g., tape with label).

7.1.4 Valves and Fittings

Only knowledgeable personnel should handle the valves in any way. The gas bottles have distinct threaded connections according to the type of gas it contains. The basic differences (numbers refer to pg. 53):

- Left thread (1) (this means turn counterclockwise to open)
for combustible gas
 - Right thread (1)
for non-combustible gas
 - Screw valve (1) (can only be opened with special wrench)
for corrosive gas (chlorine, hydrofluoric acid, etc.)
 - Inner thread (this means pressure reduction valve would be screwed into the threaded pipe (2))
for compressed air, acetylene
 - Outer thread (this means pressure reduction valve would be screwed, as above in (2), with a connecting nut over the threaded pipe)
for oxygen, nitrogen, hydrogen, etc.
-
- The use of **adaptor valves** is allowed only in rare cases because of the risk of dangerous mix-ups. In each case, it is necessary to meet extra security measures (training of personnel, supervision, etc.).
 - For the corresponding gas, use **only certified pressure regulators**. This applies **especially for compressed oxygen**. Only absolutely oil-free and fat-free fittings with flame-resistant seals issued by the Swiss Association for Welding Technique (Schweizerischen Verband für Schweisstechnik - SVS) (refer to Chapter 7.2.5).

7.1.5 At the Place of Use

- If the cylinder is only needed for a short time at a specific place, it can be used in a lying position (except for liquid gas). Standing cylinders must at least be **secured with a fire-resistant chain**. If the cylinder will be used regularly or for a longer period of time, it should be secured with permanently mounted clips, clamps, chains, or similar.
- Small gas bottles with a height amounting to not more than 2.5 times its foot diameter can stand without the additional stabilization.
- **No part of a pressurized gas cylinder** may be set at temperatures **over 40°C for liquids and over 60°C for compressed gases**. The location is to be selected accordingly (not in the proximity of heaters, hot liquefying baths, etc.).

Remember that **some gases react with certain materials violently** (refer to Chapter 7.2).

When using **corrosive gases** (chlorine, hydrogen fluoride, etc.) the valve must be used frequently in order to avoid blockage. The pressure-regulator should not be left on the bottle unless it is often used. Close the valve after every use and rinse the pressure reduction valve with dry air or nitrogen.

Further precautionary measures are described in **Chapter 3.2 - Chemical Reactions under Increased Pressure**.

7.1.6 Placing into Operation

Liquefied gases

Liquefied gases are taken at a pressure so that the vapor pressure corresponds to the room temperature.

When one takes a large amount of gas, the contents **cool off strongly** due to the necessary heat of evaporation (see equation, pg. 49). In this case, the bottle can be warmed in a water bath (not over 40°C!), so that the casing does not incur any damage due to the low temperature. Do not use any heating tapes, infrared emitters, or similar. The pressure-reduction valve may not be heated. What comes out of the bottle may be warmed by a special heating device that prevents the freezing of the reduction valve. Otherwise, withdrawal is similar to compressed gases (see below).

Generally, skin contact should be avoided when handling liquid gasses since the cold gases cause "burns". Preferably, work with gloves.

Compressed gases

The gas is taken from the compressed gas bottle by means of the pressure-regulator (see below):

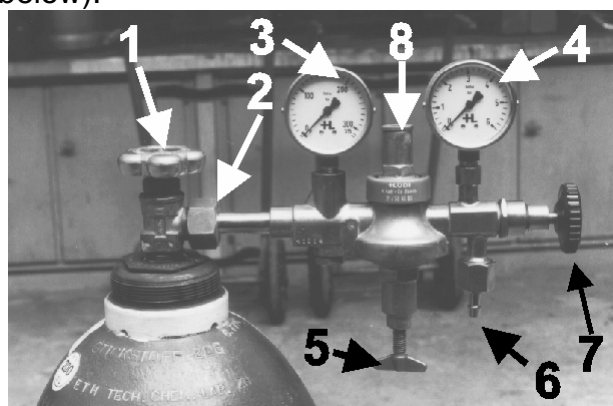

- 1 cylinder valve
- 2 junction coupling ring
- 3 contents manometer
- 4 operating pressure manometer
- 5 pressure regulator
- 6 hose connection plug
- 7 locking screw
- 8 pressure-relief valve

Abb. 7.1: Standard pressure reduction valve

Withdrawal of gas (not on the first withdrawal)

1. Check whether the locking screw (7) is closed; otherwise, close.
2. Open cylinder valve (1) slowly and without jerking (only with the hand!). Afterwards, examine whether the bolt connection (2) between the cylinder valve and the pressure-relief valve is not leaky (for example, with soapy water, never with open flame). Leakages are to be repaired immediately.
3. Examine the working pressure on the operating pressure manometer (4). Do not exceed maximum pressure (usually marked red).
4. Open locking screw (7) slowly. The gas will now flow out.

7.1.7 Placing Out of Operation

1. Close cylinder valve (1).
2. Close locking screw (7).
3. With corrosive gases, the pressure-reduction valve should also be unscrewed and flushed with dry nitrogen.
With toxic gases, flush whole system, if possible.

→ Gas bottles should never be completely emptied. They should always have an **excess pressure of at least 2 bars** left over. Empty bottles must be clearly marked as such.

→ Return the gas bottles **before the expiration date** to the distributor.

7.2 Characteristics of Selected Gases

Explanation:

Density:	at 0 °C and 1013 mbar
Vapor pressure:	at 20 °C
R- and S-Phrases:	refer to Chapter 4.3, pg. 21 to 23
Poison class:	for explanations, refer to Chapter 3.4.1, pg. 23
MAK-Value:	Maximale Arbeitsplatzkonzentration in ml/m ³ = ppm (maximum workplace concentration) At this concentration, the material does not cause damage at daily working times of 8 to 9 hours and up to 45 hours per week and also not over a longer period of time.

7.2.3. Carbon Monoxide

1. Chemical characteristics Formula: CO Form: Gas Color, Odor: colorless, odorless
2. Physical Data and Safety Indications Change of state: Melting point: -205 °C Boiling point: -191.5 °C Density: 1.17 kg/m ³ Vapor pressure: - Flash point: 630 °C Flammable temperature: 630 °C Explosive limit: 12.5 – 74.2 vol. %
3. Hazardous Reactions and Decomposition Products None.
4. Regulations Risk warning: flammable, corrosive R-Phrases: 12-23 S-Phrases: 7-16
5. Protective Measures, Handling - Personal protective equipment: With long exposure, respiratory protection recommended; wear gloves and glasses. - Handling precautions: none - Fire and Explosion Protection: Electrical installations should be explosion resistant (Ex.Schutz).
6. Measures in Case of Accident or Fire - After gas release: Vacate danger zone as soon as possible. Enter zone only with full respiratory protection and safety rope. - First aid: Rescue only with full respiratory protection. Bring victim immediately to fresh air, artificially resuscitate with oxygen. Contact a physician. Refer also to Chapter 2.
7. Toxicological Information Poison class: 3 MAK-value: 30 ppm Very dangerous! Displaces oxygen from the hemoglobin bond, being 300 times higher in affinity. Leads to asphyxiation. 0.1 % in the air is already harmful, 1% toxic. Especially dangerous due to odorless properties. First signs: headache, dizziness, tingling skin, then loss of consciousness, collapse and very weak pulse.
8. Ecological Information Considered poisonous to environment.

7.3 Behavior in Case of Accidents

Refer to Chapter 2 and Chapter 7.2.

7.4 Disposal Considerations

Refer to Chapter 3.5.

8. WORKING WITH ORGANISMS

In the following, "organisms" are understood to be biological units, which are individually visible under microscopic enlargement, such as virus, fungi, bacteria (microorganisms), or parts of it, such as cultures of animal or plant cells.

The interdisciplinary Swiss Federal Functional Commission for Biological Security in Research and Technology (Schweizerische Kommission für Biologische Sicherheit in Forschung und Technik, SKBS) divided the organisms in agreement with international guidelines (e.g., NIH) according to its hazard potential into **4 risk groups**. Risk group **1 corresponds to the smallest** and **the risk group 4, the highest hazard potential**. The risk groups have the abbreviated designations L1, L2, L3 and L4. The classifications are as follows:

- Risk group 1 (L1):** No risk of harm/damage to humans and/or environment.
Ex.: E.coli B, Aspergillus oryzae, viruses certified for vaccines, cultures from chicken eggs
- Risk group 2 (L2):** Slight risk of damage to humans and/or environment.
Ex.: Enterococcus faecalis, Candida albicans, Influenza virus, Giardia lamblia
- Risk group 3 (L3):** Moderate risk of damage to humans and/or environment.
Ex.: Mycobacterium tuberculosis, Zymonema dermatitis, Hepatitis-C-Virus
- Risk group 4 (L4):** High risk of damage to humans and/or environment.
Ex.: no bacteria or fungi, Ebola virus

A complete listing will not be given due to space limitations. You can find it in the Guidelines for Working with Genetically Altered Organisms (Richtlinien für das Arbeiten mit gentechnisch veränderten Organismen) from the SKBS. (See references).

At ETHZ, practically all (natural science) institutes work with organisms. Currently, only organisms of groups L1 and L2 are used. Working with organisms of group L2 already presents small risks of harm and, for hygienic reasons; work with organisms of group L1 necessitates certain precautionary measures, at least in respect to the protection of the microorganisms.

For each group of risks, the SKBS has issued special safety regulations, which concern both the infrastructure of the laboratory and behavior therein. The following deal with behavior in laboratories of class 1 and 2. We have tried to summarize the current general guidelines. In individual laboratories, additional safety regulations can apply. Subsequently, special aspects of behavior in contamination and accidents and general references to the disposal of wastes that result from work with organisms are given.

For work with chemicals, refer to Chapter 3, for general questions concerning behavior in case of accidents, refer to Chapter 2 and for general questions concerning disposal, refer to Chapter 3.5.

8.1 General Conduct

- Each laboratory that works with organisms is divided into different areas or space demarcations, which serve different purposes, e.g.
 - general laboratory work
 - writing
 - breaks
 - work with harmless organisms
 - work with organisms in group L2

For every task, use the space intended for its use. Therefore, for example, one should not do write-ups in the hood (contamination carry-over).

- **Food, beverages and tobacco** may not be stored or consumed in the laboratory.
- Wear a **lab coat** and **safety glasses** when working in the cell lab. If necessary, wear gloves (also refer to Chapter 3.4).
- **Inform yourself before beginning work** about the organism to be used and its risk potential. Which risk group does it belong? With the application of genetic procedures, the risk group of the new, genetically changed organism must be clarified. Ask the responsible person concerning any uncertainties.
- Make sure you that work with the organism occurs at the **appropriate space/place** of the risk group.
- Give yourself an **overview** of the other organisms that are being used in the same room.
- **Never mouth pipette**; use a pipetting apparatus. Dispose of the pipettes after use in the disinfection tank.
- Do not leave any materials standing in **areas of general use**. Disinfect the space after use.
- Disinfect and clean (in this order) all contact points of **devices** each time after it has been used with organisms.
- Whenever possible, proceed with **inoculations** of organism under the laminar flow box.
- Clean your **organism workspace** every day and disinfect it. Dispose of old organism material that is no longer necessary (refer to Point 8.4).
- **Contaminated materials** must be autoclaved prior to disposal.

8.2 Behavior in the L2 Lab

- Working in the L2 lab is only allowed with **special permission** and after **briefing** from the bio-safety officer.
- **All general instructions (refer to above) also apply to the L2 lab.**
- Persons with **open skin injuries**, especially on the hands, should not work at the L2 lab.
- The application and removal of **cosmetics** (also moisturizing creams, etc) is not permitted.
- Wear a **lab coat** when working at the L2 lab and gloves (possibly 2 pairs) and eye protectors if handling infectious or poisonous agents.
- **Wash and disinfect hands** before entering the L2 lab.
- Avoid **skin contact** with materials that contain organisms with hazard potential. Immediately disinfect any areas that have come into contact with the contamination source.
- If possible avoid the **use of needles or sharp objects** (danger of injury and infection).

Before starting work:

- Check that the **waste containers** are not yet full.
- **Disinfect** the workspace and the hood of the laminar flow box.
- Make sure you **that all necessary materials** are available in **sufficient quantity**.

During work:

- Arrange all materials in such a way that you always have an **overview** of them, so that it is obvious which is contaminated and which is not.
- Materials, which contain organisms of group L2 may be taken from the laminar flow, box **only in closed containers**.
- **Only use plastic pipettes**. Disinfect contaminated pipettes in an appropriate way.
- Also disinfect other **contaminated materials** (e.g., add disinfectant to plastic containers). Dispose of Kleenex and gloves in a separate container.
- Immediately remove **spilled materials** with a tissue that has been soaked in a disinfectant.
- Avoid, if possible, producing **aerosols** (stirring, centrifuging, pipetting etc.). Containers that can be a source of aerosol should be opened only under the laminar flow box.

- Immediately dispose of **empty glassware, etc.** Keep in the laminar flow box only those items that are needed for the moment.
- Never touch the **microscope eyepiece** with gloves that were used while working with organisms.

After work:

- Remove **gloves** (not only contaminated) and place in waste container that will be autoclaved. **Wash and disinfect hands.**
- Place organisms, which should be stored in a suitable container.
- Place containers with used pipettes and other **wastes** in its appropriate place or bring in for autoclaving.
- Control **waste containers** and if necessary, replace and bring the full one in for autoclaving
- **Disinfect** laminar flow box and hood in an appropriate way (UV light etc.).
- **Before leaving the lab check the following:**
 - Removed gloves?
 - Turned off waterbath?
 - Turned off microscope and other devices?
 - Turned off vacuum?
- For **transporting** materials that contain organisms of group L2, use well-constructed, shatterproof containers with secure lids. Obey the special instructions of the bio-safety officer.
- **Remove lab coat before leaving L2 lab.**

8.3 Behavior in Accidents and Contamination (L2)

8.3.1 Contamination (L2)

- Dispose **contaminated gloves** immediately in container with disinfectant.
- Place **contaminated lab coat** in a waste bag and autoclave before cleaning.
- Disinfect **contaminated area** in an appropriate way. When possible, also autoclave contaminated material.
- **Report serious contamination** to the responsible persons.
- If a **container with organisms belonging to group L2 breaks** outside of the L2-Lab, try to contain the area of contamination as much as possible, prevent the spread of contamination and immediately inform the responsible persons.

8.3.2 Accidents

- Immediately disinfect **contaminated skin** and wash afterwards. If possible, encourage self-cleansing of **bleeding injuries** by forced blood withdrawal. Subsequently, disinfect wound and take care of as usual.
- **Report injuries** to responsible persons and the Abt. S+U.

Accidents in L2 lab:

- Employ first aid **in** the L2 lab.
- If victim is able to walk, leave the L2 lab and seek medical aid. Otherwise, inform medics (Ext: 0-114).
- If there is **contamination** involved, in addition to the injuries, give medical aid in L2 lab, if necessary. Leave the lab only after disinfection.
- **First aid:**
 - **If liquids with organisms belonging to group L2 enter the mouth:**
Spit out immediately and rinse with a disinfection solution for 3 minutes. Subsequently, rinse mouth with clear water and go to emergency first aid station.
 - **If liquids with organisms belonging to group L2 enter the eyes:**
Thoroughly rinse eyes with eye-rinsing liquid or water. Subsequently, go to emergency first aid station.
- General instructions for first aid: refer to Chapter 2.

8.4 Disposal Considerations

- **All materials that have come in contact with the organism** must be **sterilized before its final disposal**. In general, an autoclave is used. Inform yourself before starting work about the labels used for the wastes and other practices that apply in your lab.

Literatur:

Interdisziplinäre Schweizerische Kommission für Biologische Sicherheit in Forschung und Technik (SKBS):
Richtlinien für das Arbeiten mit gentechnisch veränderten Organismen. Zürich; 1992

9. WORKING WITH LASERS

The term “laser“ is the abbreviation of “**L**ight **A**mplification by **S**timulated **E**mission of **R**adiation“. Laser devices serve to amplify light of a specific wavelength such as the production of tightly bundled light emissions of same wavelength. For the production of the laser light, a medium (e.g., a ruby crystal with a solid state laser) is shifted into an excited state, from which it returns with light emission to its original condition. The emitted light is strengthened and bundled.

Lasers are used at ETHZ, for example, for material processing and testing and for structural and electrical analysis. Moreover, you encounter weaker lasers also in laser printers, CD players or laser pointers.

Lasers are divided according to the strength of its power spectrum (performance and radiation emissions) into **4 classes**:

- Class 1:** Harmless to the human eye
< 1 mW
e.g.: laser pointer
- Class 2:** Harmless to the human eye with brief exposure due to blinking reflex
until 50 mW
(until 0.25 seconds)
e.g.: laser printer
- Class 3A:** Harmless to the human eye with exposure time of 0.25 seconds, dangerous for the human eye when using optical instruments which make the radiated light diameter smaller.
until 500 mW
e.g.: technical applications, research etc.
- 3B:** Dangerous to the human eye and in some cases, to the human skin
e.g.: technical applications, research etc.
- Class 4:** Very dangerous to the human eye and dangerous to the human skin
> 500mW
e.g.: technical applications, research etc.

Thus, at ETHZ, all laser classes are represented. The following, however, particularly addresses the danger of lasers belonging to classes 3 and 4.

The direct danger to the human eye by lasers arises as a result of the extremely high power intensity of the laser beam (see below). While a conventional source of light radiates into the full area, the laser beam is bundled on a very small solid angle.

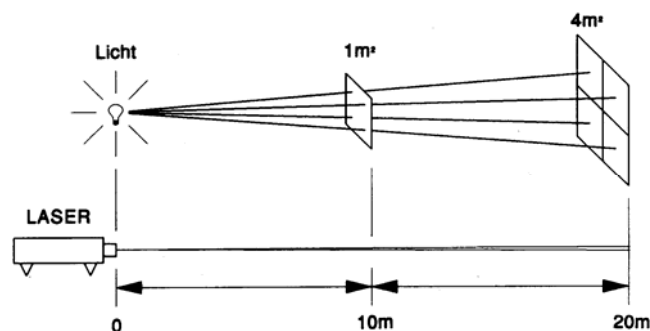

Fig. 9.1: Comparison of the radiation angle of conventional sources of light and lasers

Due to their high power intensity, reflected rays can also be dangerous. Thereby, the weight of the damage depends on:

- the strength of the radiation,
- the wavelength used,
- the impact time of the laser light, and
- the absorption behavior of the illuminated materials.

The wavelength is crucial for the damaged region of the eye. Radiation within the visible and near the limits of the infrared range (400 to 1400 Nm) can endanger the retina. UV and far infrared radiation (100 to 400 or over 2500 Nm), however, damages the lens and the cornea.

The **largest danger for the eye** comes from **lasers with high power intensity** and **lasers with wavelengths between 400 and 1400 Nm**. On one hand, lights of these wavelengths, which reach the retina, are focused further by the refractive eye media. On the other hand, lights with wavelengths over 700 Nm are not visible to the human eye, which increases the probability of an accident. High intensity radiation causes tissue vaporization, in this case, retina coagulation. Pulsed lasers are particularly dangerous in this way because of their capacity to produce from and up to several TW (= 10^{12} Watt) in a short time. The effects of retina injury depend on the location of the damage. Particularly serious damage arises upon viewing directly into the beam since in this case, light is focused on the “yellow spot,” the part of the retina where one uses to see sharply. The further the damage is from the yellow spot, the lesser the impairment to the vision.

Laser radiation on the **human skin** has, on the one hand, photochemical and, on the other hand, thermal effects. Skin injuries caused by lasers are reversible, as a rule. Usually only the epidermis is damaged. Light with wavelengths of 400 to 1400 Nm can penetrate down to the subcutaneous tissue; therefore, also mutagenic effects cannot be excluded.

However, **indirect dangers** can also result from lasers. The efficiency of energy conversion is very small, which is why most devices are operated with high power. Different components of the laser, e.g., the stimulated medium or the optical components, can be toxic. With the treatment of materials (e.g., when cutting metals) toxic materials can, likewise, develop. Not to be forgotten are also the constant danger of fire and explosion, which can arise as a result of the possible ignition of liquids and gases upon irradiation of the laser.

Lasers are, thus, not completely harmless devices. The following general behavioral rules help you to avoid risks and accidents with lasers. Chapter 9.2 describes correct behavior in case of accidents with lasers. For general questions regarding first aid, refer to Chapter 2.

9.1 General Behavior

- **Never** work **alone** with lasers (exception: permanently installed machines).
- When working with lasers, **consistently** wear **laser eye protectors** for the appropriate type of laser. Goggles are located at the entrance of the room.
- Perform adjustments only when wearing the appropriate **laser adjusting glasses**.
- **Never look directly at a laser beam**.
- If possible, always work with **sufficient lighting** . The pupils close with sufficient brightness and, thus, the probability of an accident also decreases.
- When operating lasers, **do not wear watches, rings, eyeglasses** or other reflective objects that could reflect (deflect) the laser.
- When laser work is done often in the dark, keeping **order in the laboratory** can prevent accidents (stumbling, etc.).
- **Equipment assembly:**
 - The laser beam may run only above or below **eye level**. If the laser apparatus absolutely needs to be at eye level, shields must be placed which block the path of the rays.
 - Never direct a laser beam toward the entrance of a room, a window (reflection) or chemicals (fire and danger of explosion).
 - Rule of thumb: **No laser beam leaves the table boundaries uncontrolled**. Use non-scattering, non-reflecting protection shields and light-absorbing covers for the protection of visitors.
 - Should a laser beam have to leave the table boundaries, it should only be directed at **non-reflective wall elements**.
- Pay special attention the **warning light** located at the entrance of the laser laboratory. Also use them yourself.

The following apply:

Red: **Do not enter**. Knock and wait.

(possible danger to visitors due to work with high energy laser beams, by measurements, recordings, calibrations, etc.)

9.2 Behavior in Case of Accidents

If a laser beam has caused an injury, it is **not possible to minimize the damage through immediate first aid!** More important than the immediate seeking of aid in an emergency station is the prevention of further accidents. Therefore, heed the following instructions:

- Remain calm, do not immediately run away.
- **Switch off laser.** Likewise, **switch off other possible sources of danger** for entering visitors.
- **Inform responsible persons.**
- Only now, with accompaniment, should you seek help at the ophthalmic clinic (map, refer to p. 6).
- After the examination, inform responsible persons, as well as the Dept. of Environmental Health and Safety (Abt S+U) about the extent of the damage.

Burning of the skin:

- Soak affected skin immediately in cold water until the pain is relieved.
- Proceed as described above.
- Burns caused by a laser should be treated in each case by a physician (refer to map of emergency first aid station, p.6).
- After the examination, inform responsible persons, as well as the Dept. SHE about the extent of the damage.

References:

VDI-Technologiezentrum Physikalische Technologien (Hrsg.): Sicherheit in der Lasermaterialbearbeitung.
VDI-Verlag; Düsseldorf; 1990

10. WORKING AT THE MACHINE SHOP

At ETHZ, you yourself can carry out mechanical work such as welding or sawing at the recreational workshop (HG D 38.2). At the apprentice workshops at Höggerberg, apprentices are trained in mechanical work. With the production of models for the architectural studies, one also needs solid knowledge of simple mechanical work such as cutting or sawing. Exactly in this area do accidents often occur, such as the loss of a fingertip, since the danger of sharp cutting instruments is often underestimated (also refer to 10.1.1).

In this chapter, you will find guidelines for behavior in workshops that you must seriously consider, in order to avoid accidents. Chapter 2 informs you about correct behavior in case of accidents. Questions concerning the disposal of wastes are found in Chapter 3.5.

10.1 General conduct

- Wear **safety glasses** when in the workshop.
- For the protection of clothes and to prevent loose articles of clothing from being seized by a machine, wearing **overcoats or dresses** is recommended.
- Reduce **arm, throat, and finger jewelry** to a minimum.
- Hearing damage is irreversible! Therefore, **protect your hearing** when you are working within the range of loud machines (also refer to Chapter 1.2.4). Consistently wear hearing protection at noisy workspaces because even short noise events can lead to hearing damage. Whistling or humming in the ears in calm environment are already indications of a slight damage.
- Close **drawers** of toolboxes, etc., as soon as you take out what you need (danger of injury for you and others).
- Always immediately remove shavings, material remains, oil or water spills, etc., that are lying about on the floor (danger of slipping and stumbling).
- **Interrupt the current supply** (cable or fuse) **before each manipulation** of an equipment or a machine. If the fuse is removed, attach a **warning sign** on the fuse box so that no one inadvertently replaces the fuse too early.

10.1.1 Sharp Cutting Tools

- When working with sharp cutting tools, **proper cutting technique** is of the utmost importance:
 1. The tips of the forefinger and middle finger must be at the same height as the tip of the thumb
 2. The fingers should be bent when holding a work piece, not extended out.

3. If possible, blades should not be pulled directly alongside the fingertips but some centimeters away. If necessary use aiding tools (guidance rails).

10.1.2 Compressed Air

Compressed air is often used for blowing off work pieces or for cleaning the working place of splinters and other dirt.

- Always wear **eye protection** when working with compressed air (danger of eye injuries from flying particles).
- **Never direct compressed air to yourself or others.** It can result in serious injuries such as hearing loss or small wounds enlarging to involve of large parts of the body.
- Vacuum the machines before they are cleaned with compressed air.
- Use caution when cleaning off **metal shavings coming from stainless steel.** Do not touch with bare hands!

10.1.3 Welding, Brazing

- Always wear special **welding eye shields** when doing welding or brazing work. Otherwise, there is the danger of blinding or eye inflammation by the strong light radiation of the flame and the welded joint (high amounts of UV).
- Since glowing metal sprays or drip is inevitable when gas welding, an **overcoat** must be worn. Pay attention that it is oil- and grease-free. Avoid wearing easily flammable textiles (artificial fibers).
- Make sure that the **welding or brazing area is clear of oil or solvent containers.** Do not work on areas that are flammable.
- **Never oil bolt connections** of welding equipments.
- Do not lay a burner on top of flammable pieces such as rags, etc.; instead hang it on its designated space.
- **Hoses** of a burner apparatus may not be **laid out** in such a way that you or others could stumble over them.
- Make sure that **the hoses are in perfect condition.** Immediately report tears or other damages to responsible persons (danger of injury and explosion).

Procedures for start of welding:

1. Open the valves of the gas bottles slowly and without jerking (only by hand!). Examine afterwards whether the bolt connection between bottle safety valve and pressure release valve (see Chapter 7.1.6, pg. 53) is tight (e.g., with soapy water, never with open flame). Leakages are to be repaired immediately.
2. Open fuel bottle valve (could be necessary to leave in square socket wrench).
3. Set operating pressure, check the operating pressure manometer (indicated on burner insert or in the manual). Do not set too high, danger of exploding hose!
4. Open oxygen valve.
5. Open combustible gas regulator, ignite gas mixture, regulate flame.

Procedures for end of welding:

1. Close combustible gas regulator (flame expires).
2. Empty gas hoses (close tank valve, open fuel valve, open and close oxygen valve; never open both valves at the same time, danger of explosion when restarting).
3. Relieve diaphragms in the pressure reduction valves with the adjusting screws.

References:

Inspektorat des Schweiz. Vereins für Schweißtechnik: Brenngas-Sauerstoff-Anlagen; Schweißen, Schneiden und verwandte Verfahren; SBA Nr. 128.d; SUVA; Lucern; 1994

10.1.4 Machines with Rotating Parts

- When working with machines with rotating parts, wear **tight-fitting**, belt-less **overalls**. Button the sleeves or push them inwards and up.
- **Long hair** must be worn so that it does not, under any circumstance, come into contact with rotating machinery (e.g., hats, wear in a tight bun).
- **Do not wear gloves**. They could get caught on the machine.
- Never support yourself with the hands on machine parts or workpieces. Never grab a **running machine with your hand** (e.g., use a rag on a circulating spindle).
- Never work without a protective cover, safety net, on unsecured lathe dogs or the like.
- Remove the **lathe chuck key** before you start the machine (danger of injury from flying key).
- Check on the **secure attachment of work pieces** (use vice, etc).
- Avoid direct skin contact with cooling agents (boric acid solution, diluted soluble oil, cutting oil, etc.; use skin protection ointments).
- Use gloves when **removing shavings**. Use special caution with shavings from stainless steel (danger of hand injuries).

10.2 Behavior in Case of Accidents

Also refer to Chapter 2.

10.3 Disposal Considerations

Also refer to Chapter 3.5.