

**Das Unsichtbare sichtbar,  
und das Unmögliche möglich machen**

***Die Forschung am***

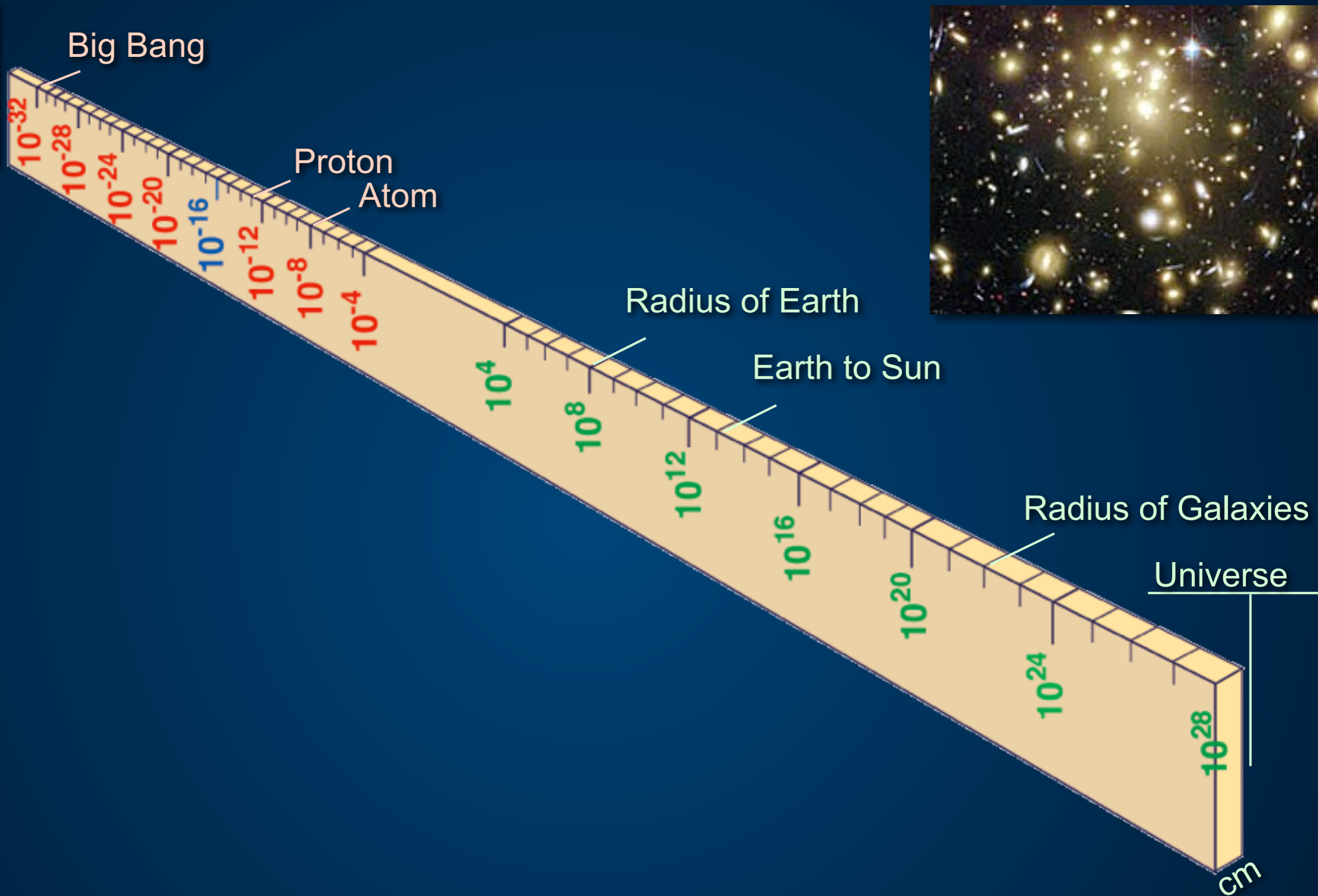

Prof. Günther Dissertori  
ETH Zürich





Big Bang

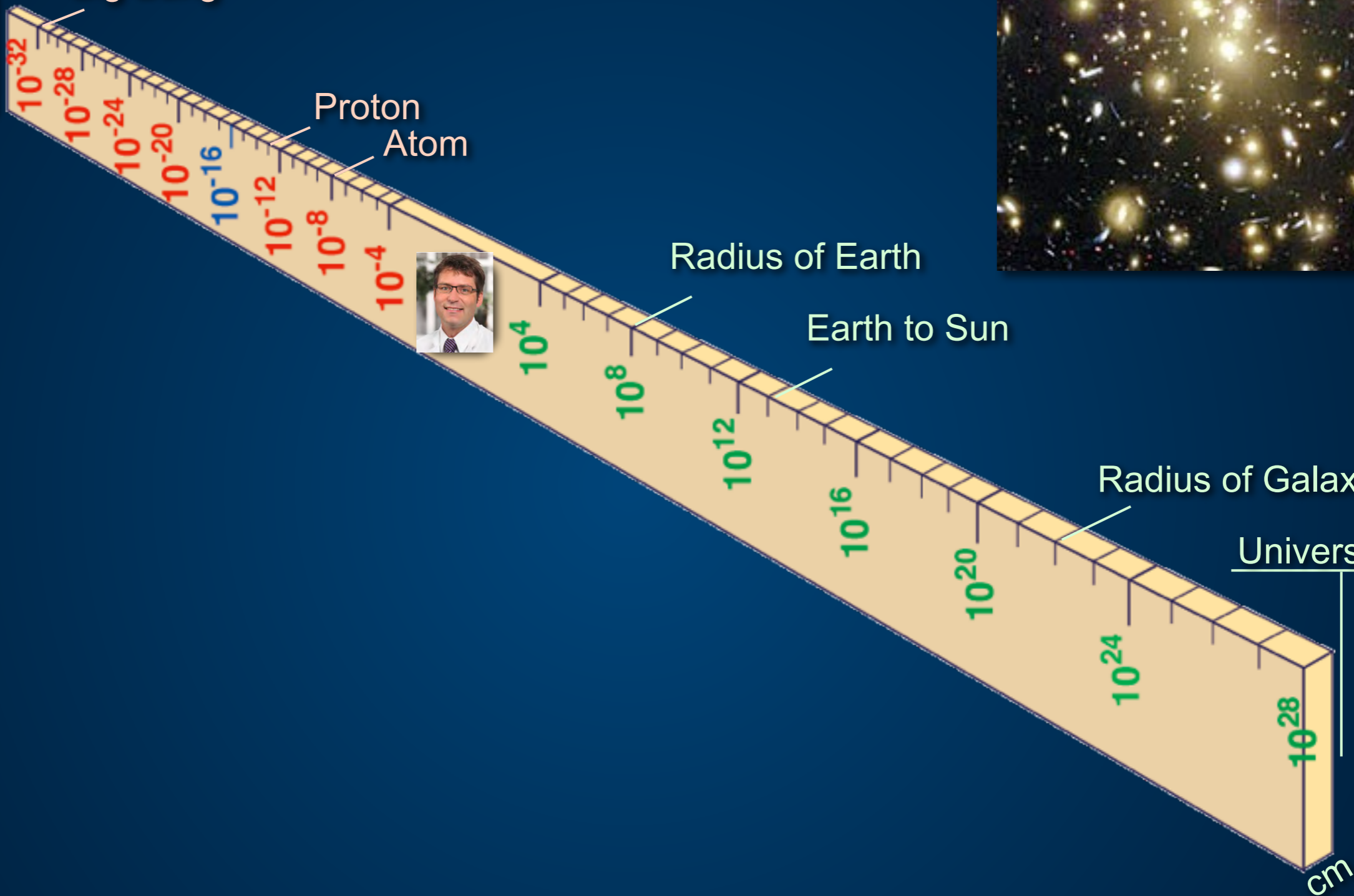



Big Bang

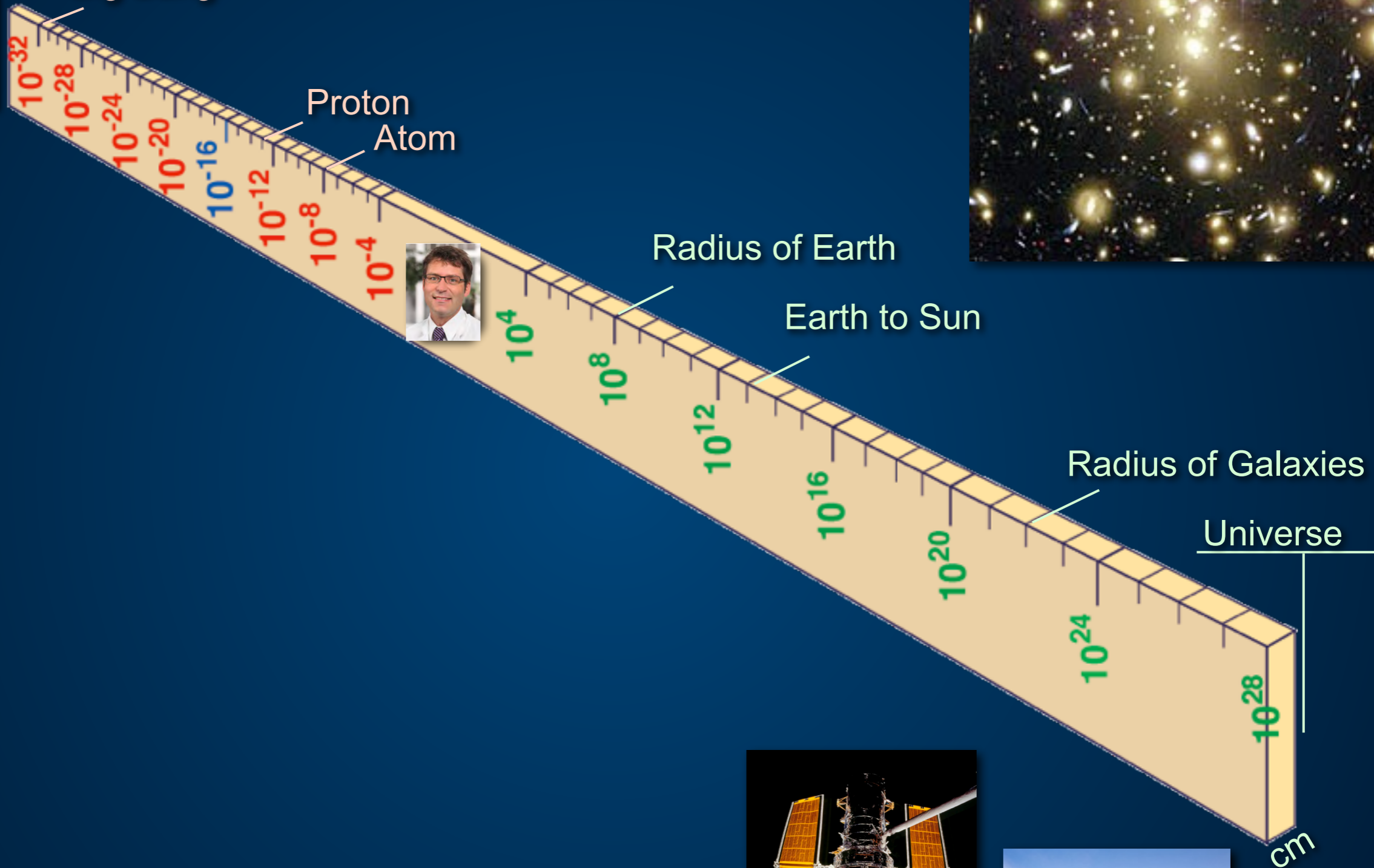



Big Bang

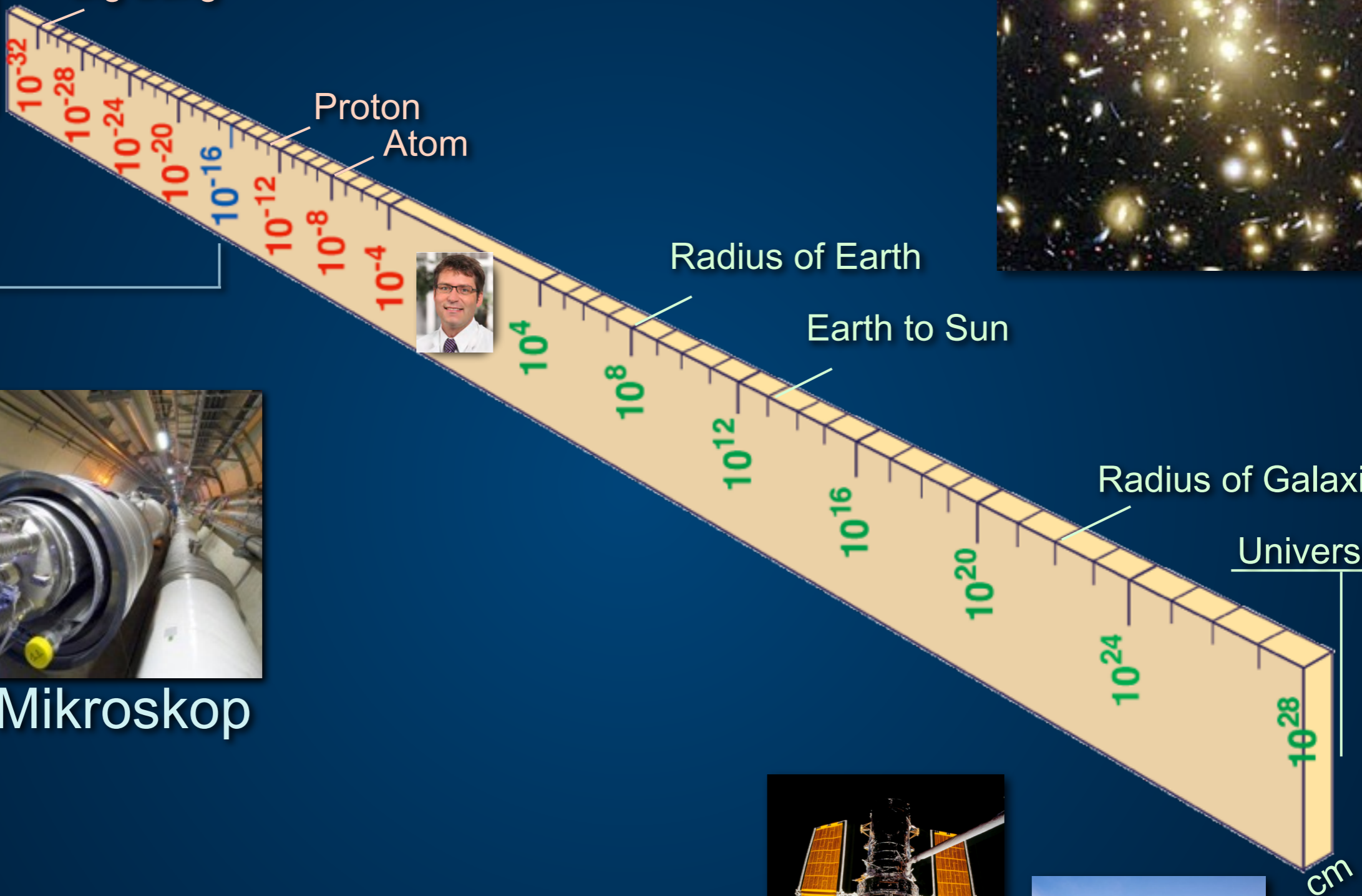

Super-Mikroskop



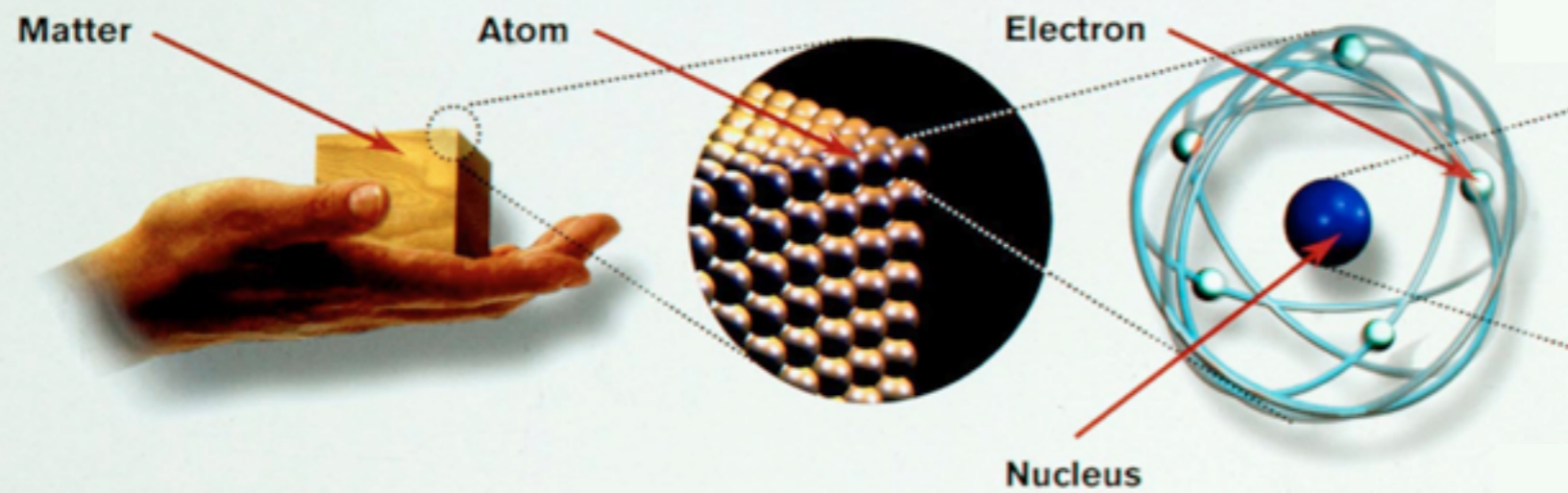

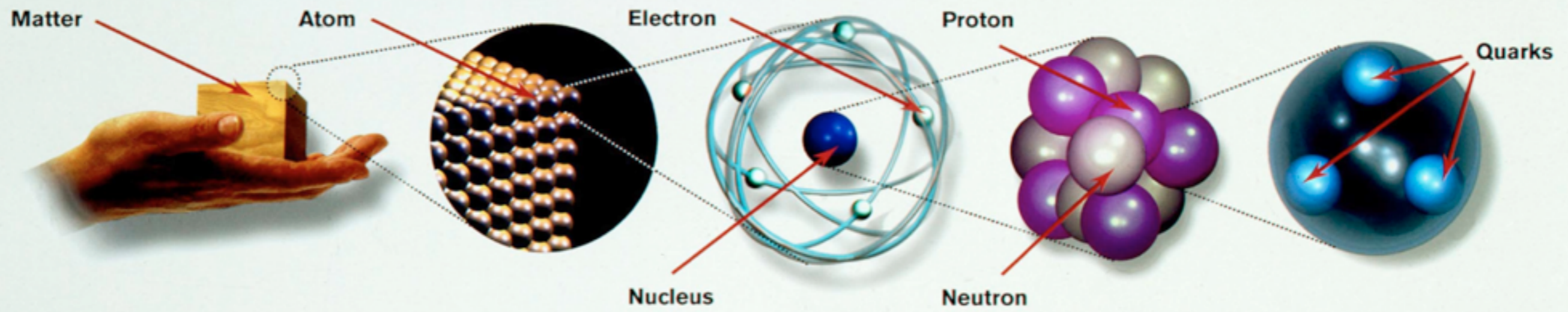





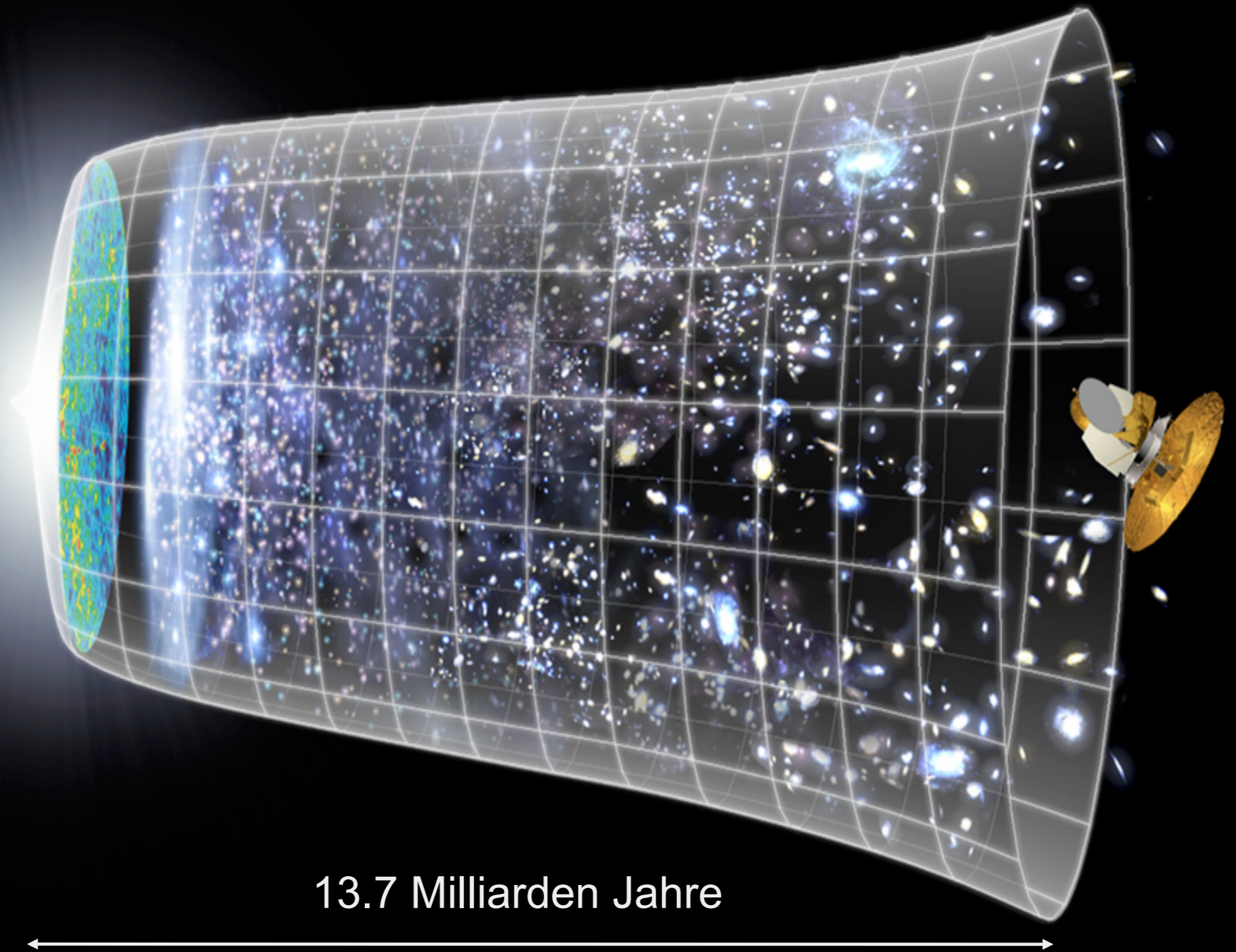

13.7 Milliarden Jahre

# Grosse offene Fragen

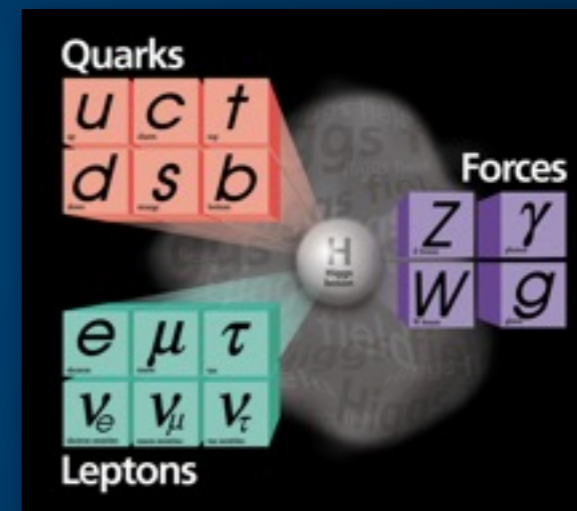
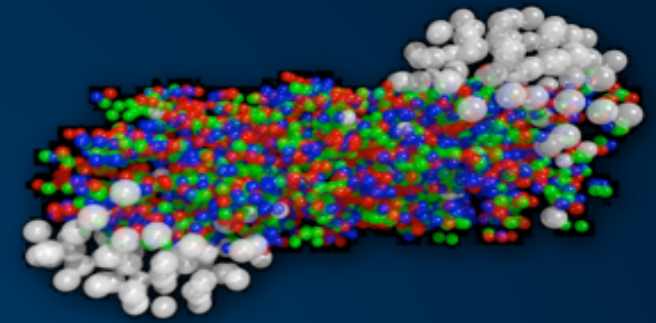

# Grosse offene Fragen

- Das Universum ganz kurz nach dem **Big Bang**

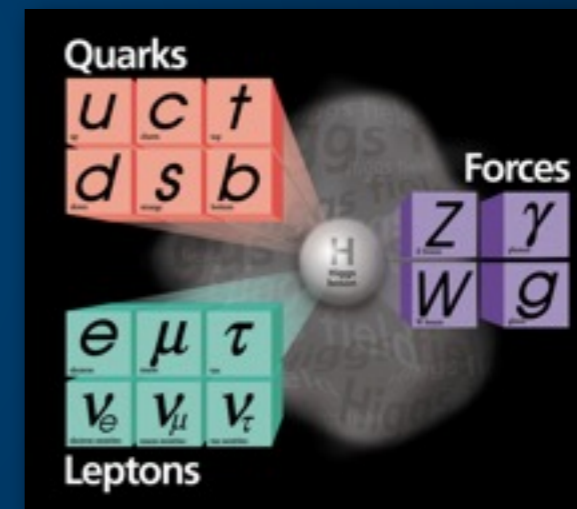
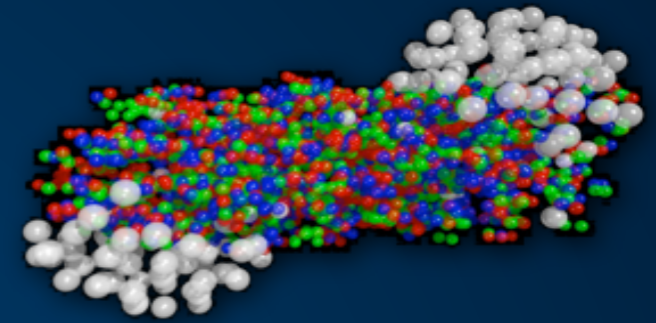

# Grosse offene Fragen

- Das Universum ganz kurz nach dem **Big Bang**

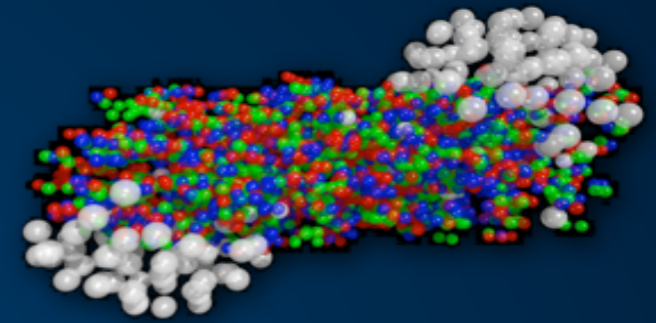

- Eigenschaften des neu entdeckten **Higgs Boson**, weitere neue Teilchen?

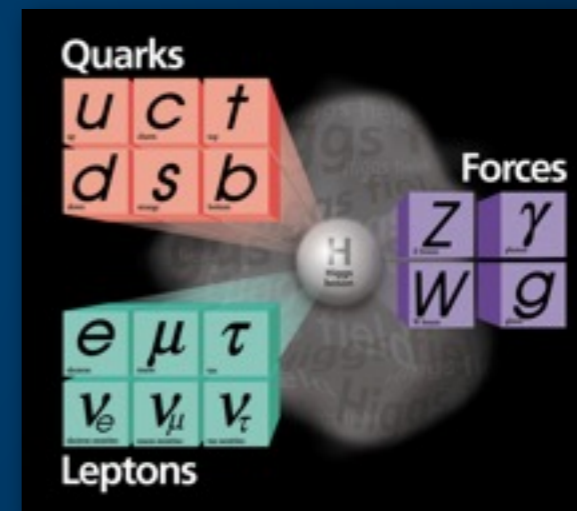

# Grosse offene Fragen

- Das Universum ganz kurz nach dem **Big Bang**

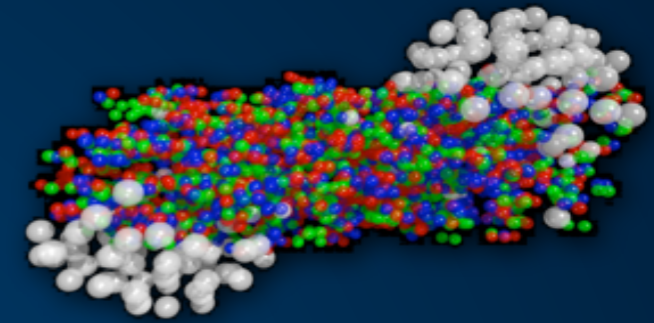

- Eigenschaften des neu entdeckten **Higgs Boson**, weitere neue Teilchen?

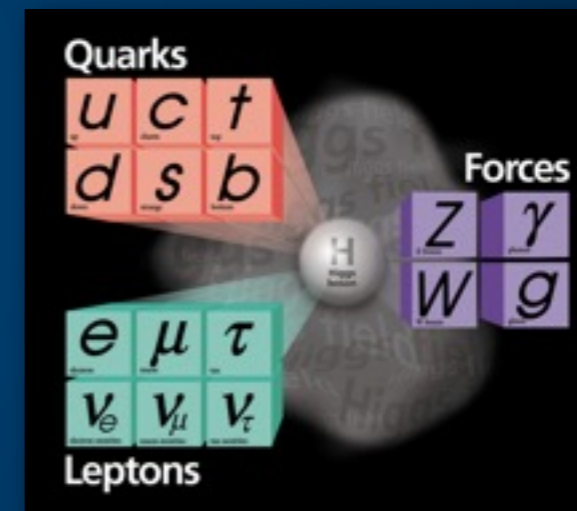

- was ist **Dunkle Materie** ?





# CERN's Mission



# CERN's Mission

- Verschiebung der **Grenzen des Wissen**

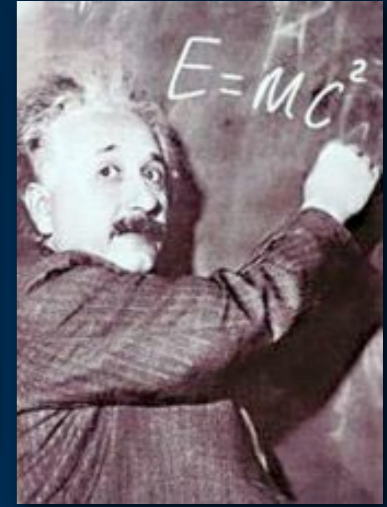



# CERN's Mission

- Verschiebung der **Grenzen des Wissen**
- Entwicklung **neuer Technologien**

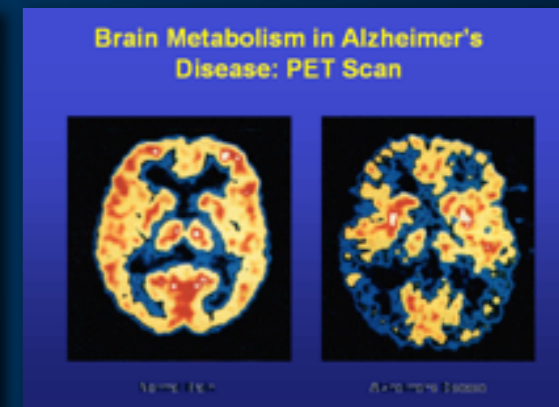
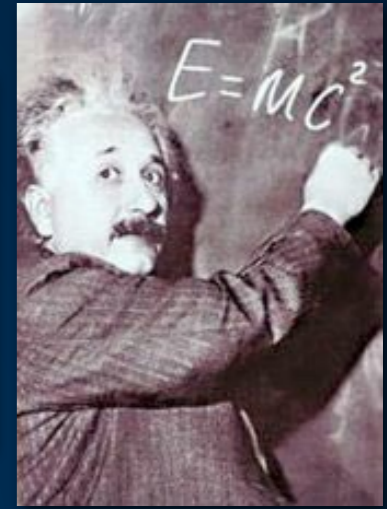





# CERN's Mission

- Verschiebung der **Grenzen des Wissen**

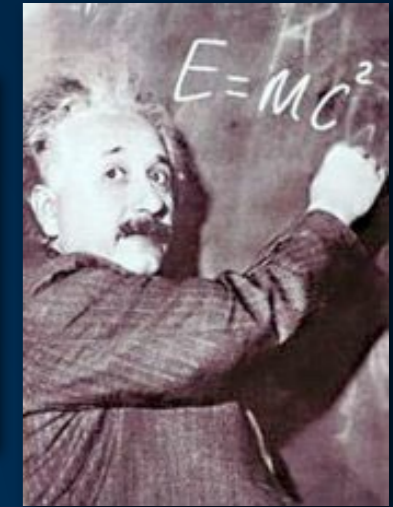

- Entwicklung **neuer Technologien**

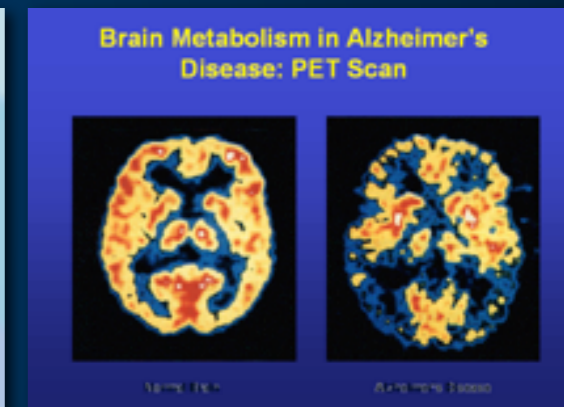

- Ausbildung der **Wissenschaftler und Ingenieure** von morgen





# CERN's Mission

● Verschiebung der **Grenzen des Wissen**

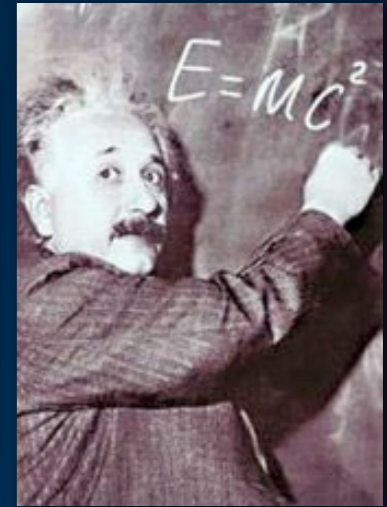

● Entwicklung **neuer Technologien**

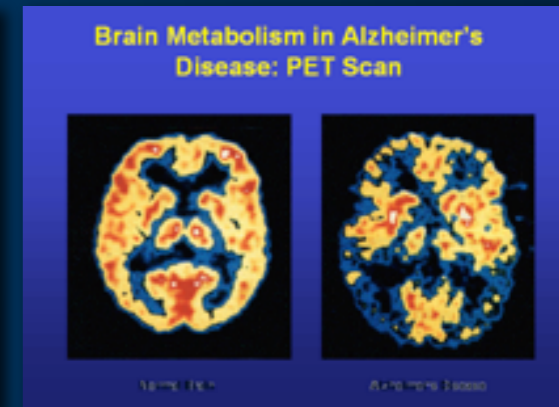

● Ausbildung der **Wissenschaftler und Ingenieure** von morgen



● **Menschen** zusammenbringen



# Der Large Hadron Collider

Eines der grössten, globalen wissenschaft. Projekte aller Zeiten



# Der Large Hadron Collider

Eines der grössten, globalen wissenschaft. Projekte aller Zeiten

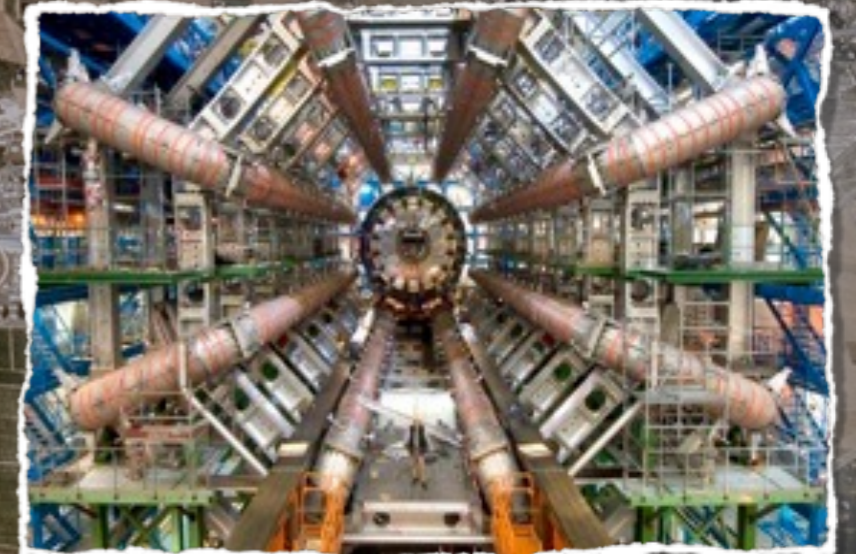

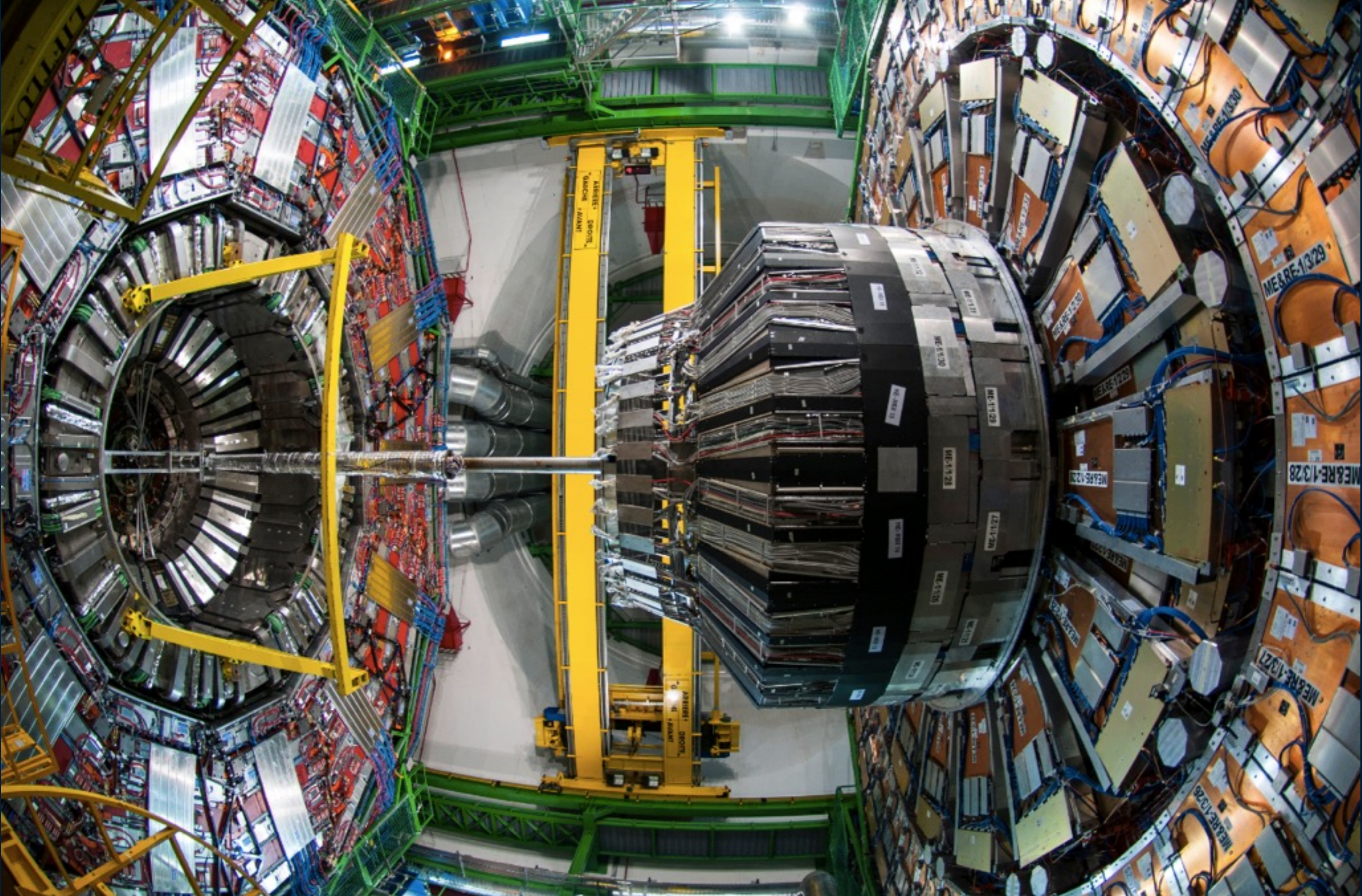





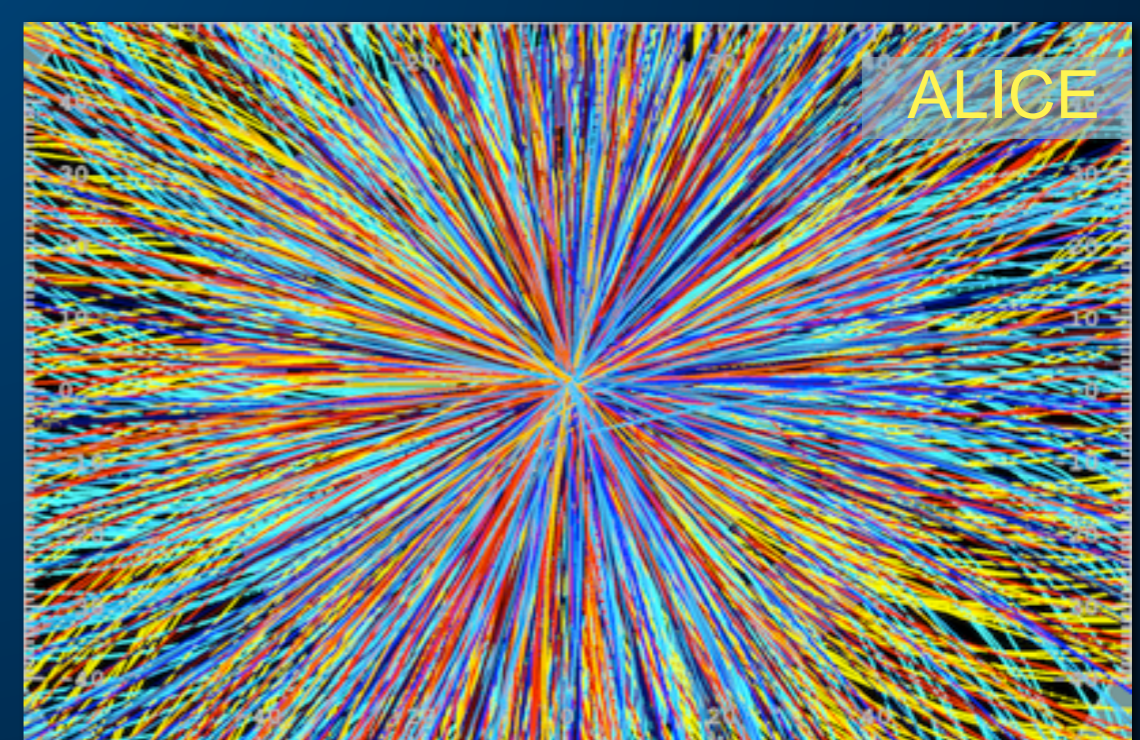
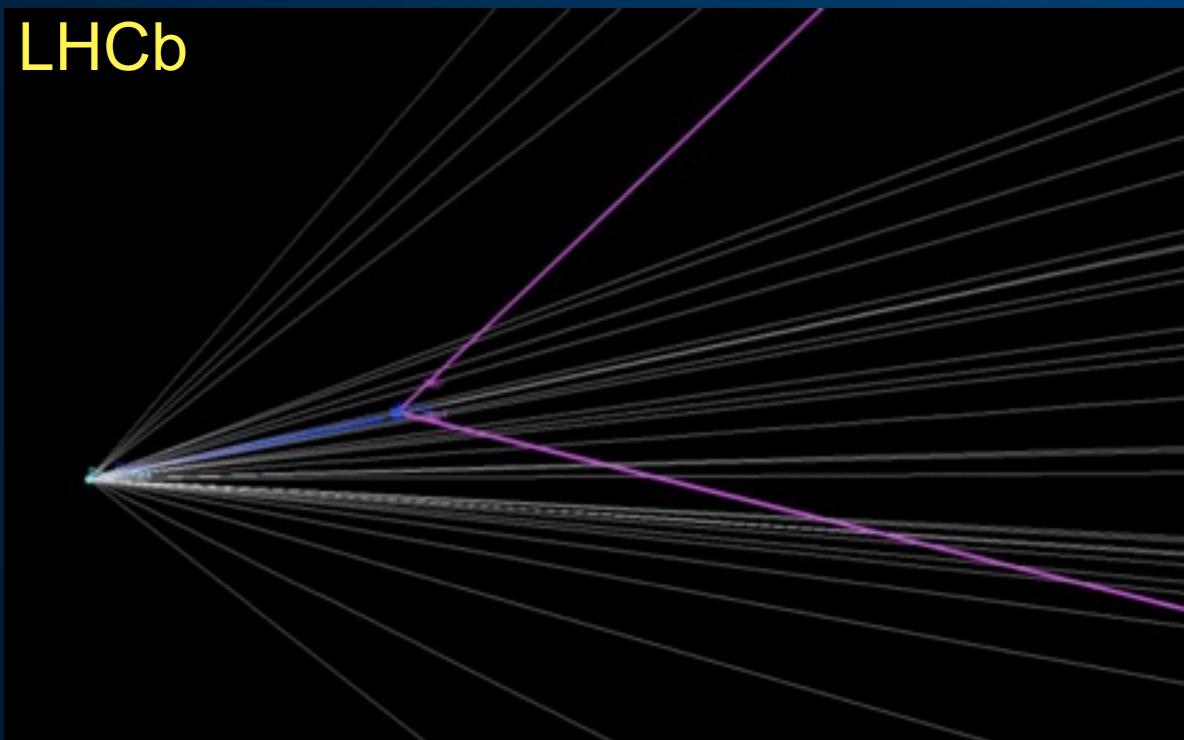
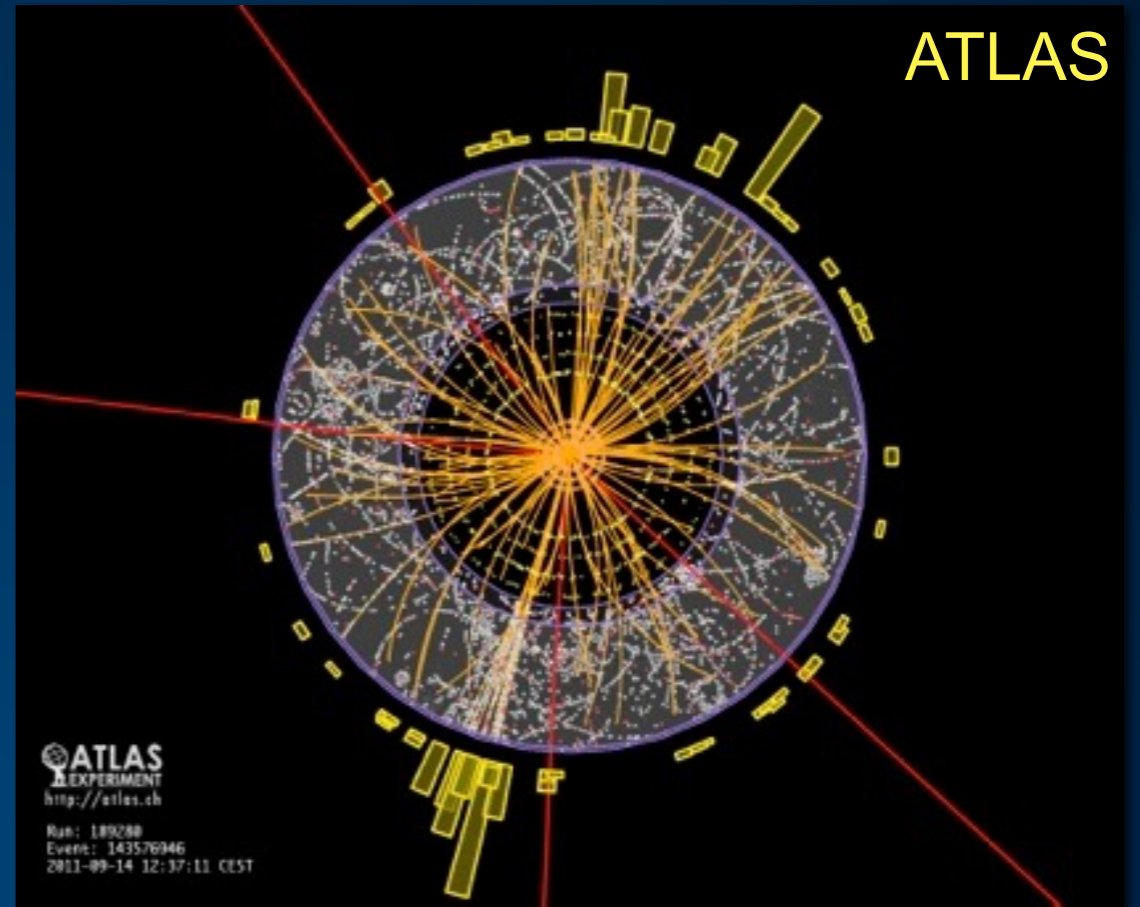
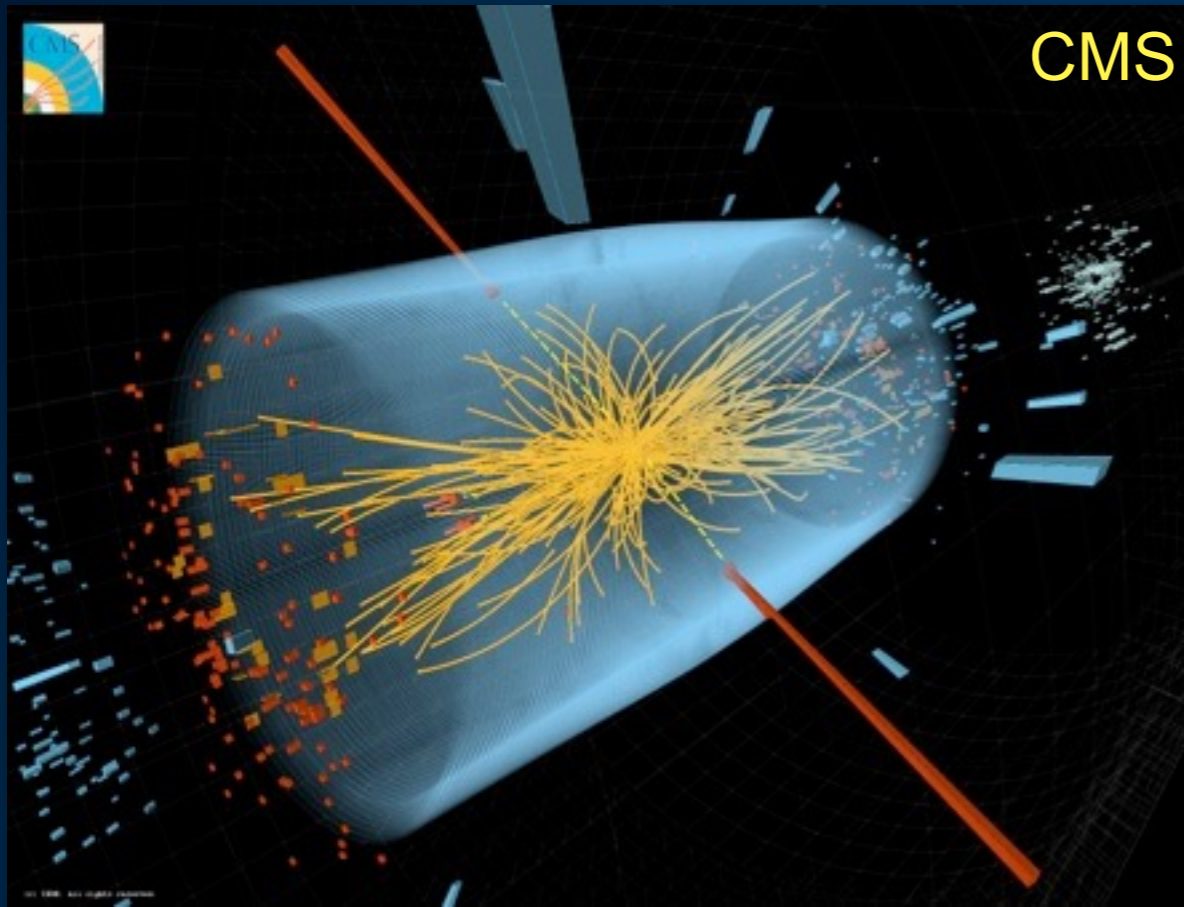



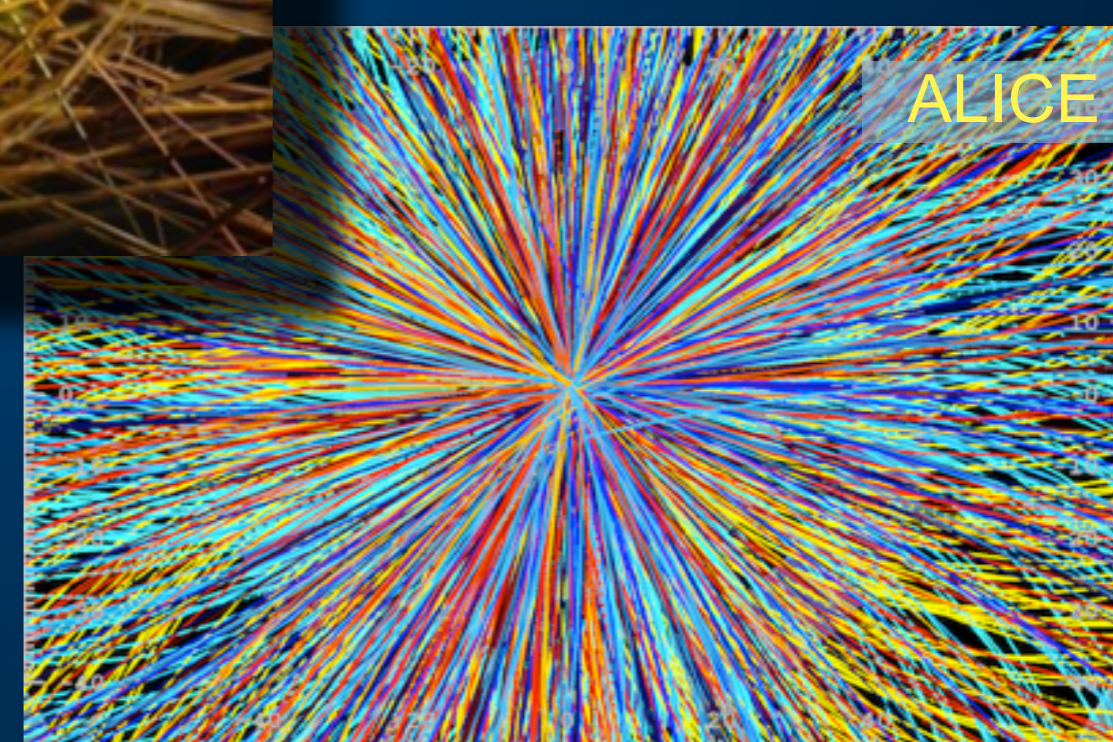
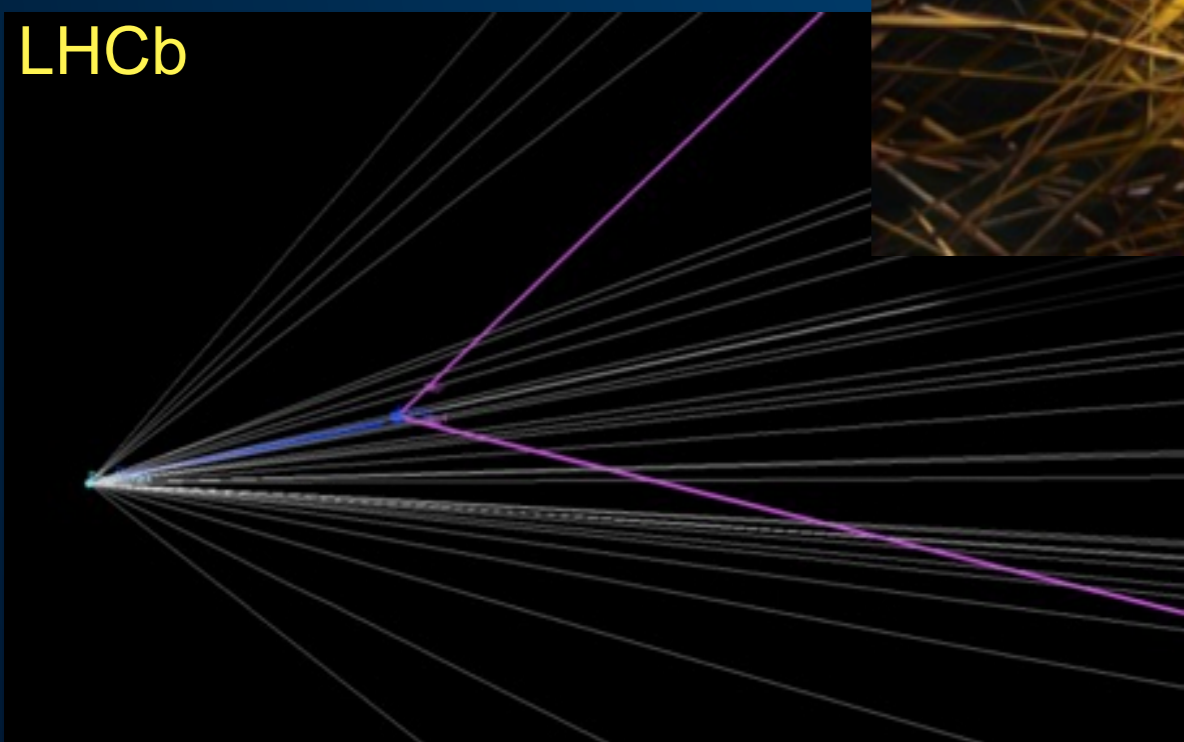
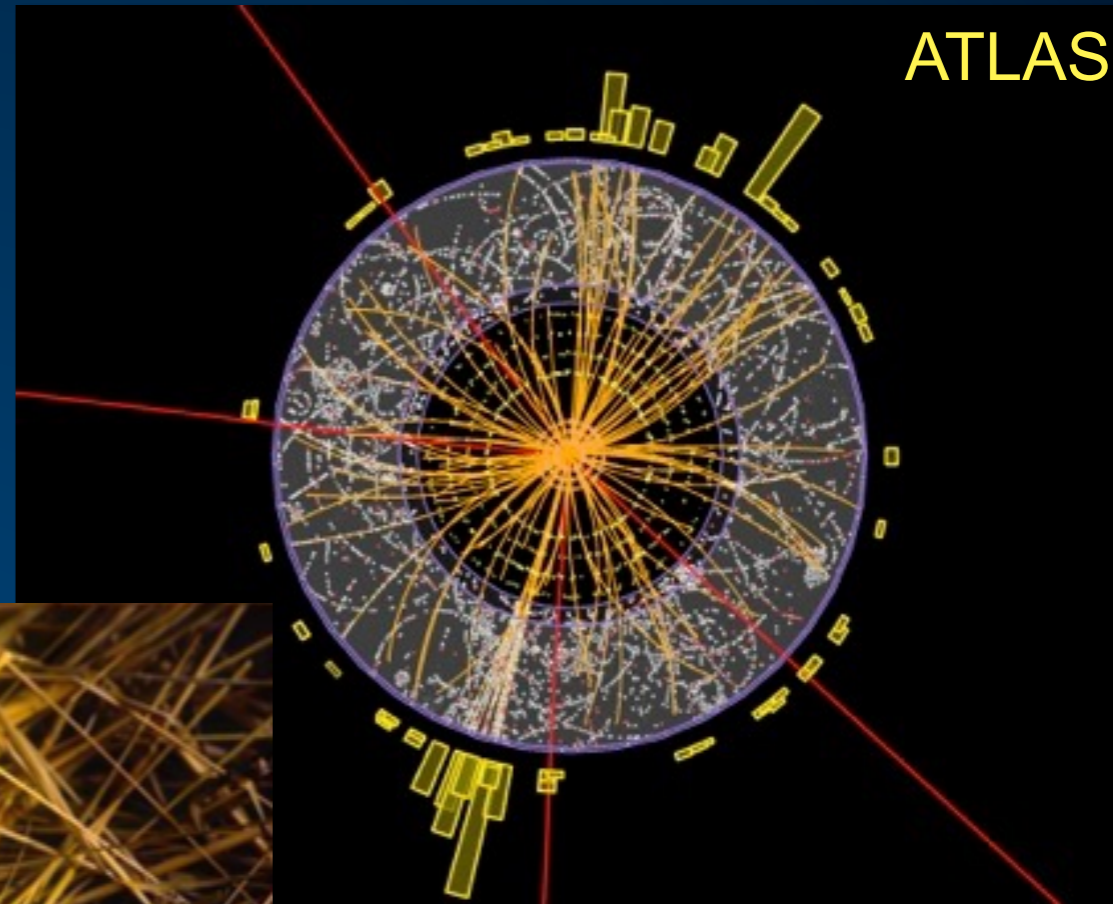
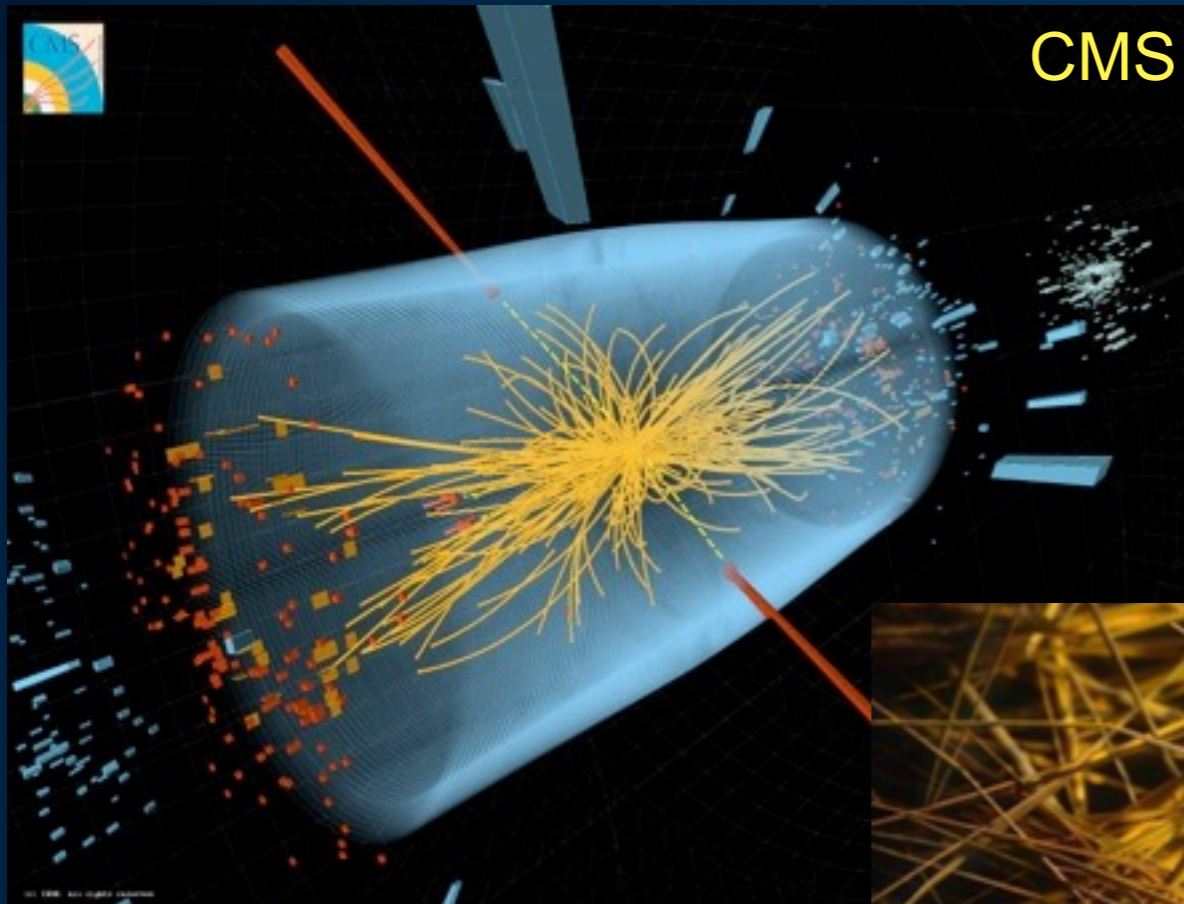

3 Gb/sec - Datenvolumen pro Jahr ~25 Petabytes

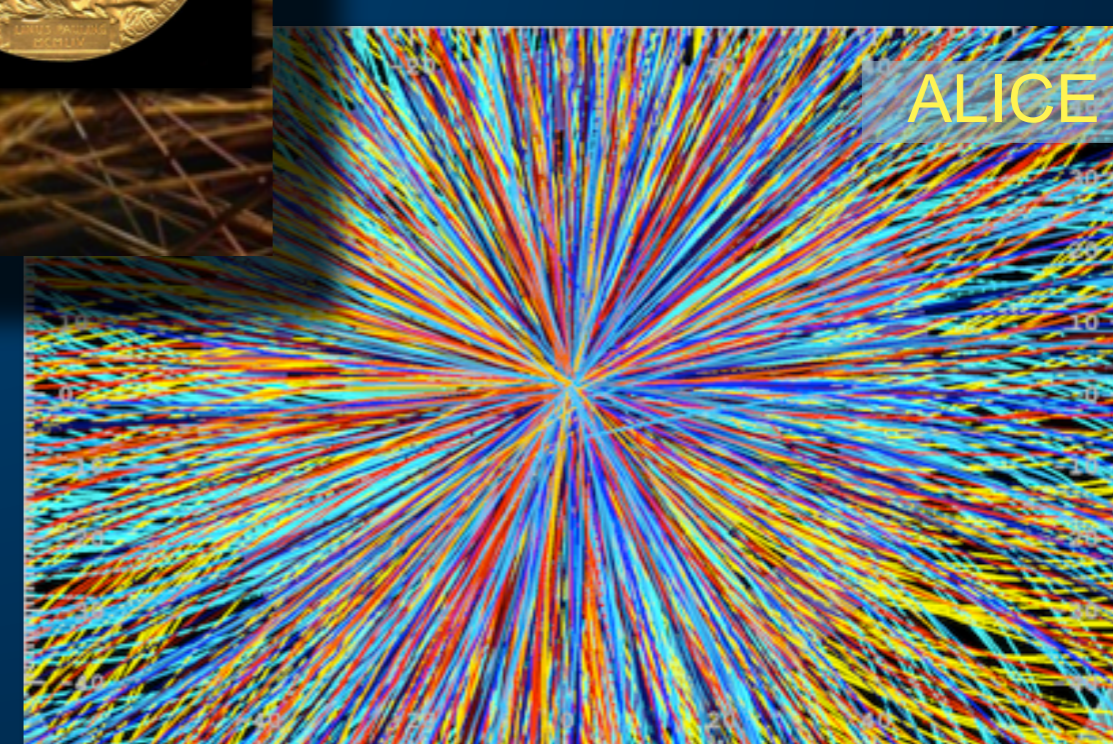
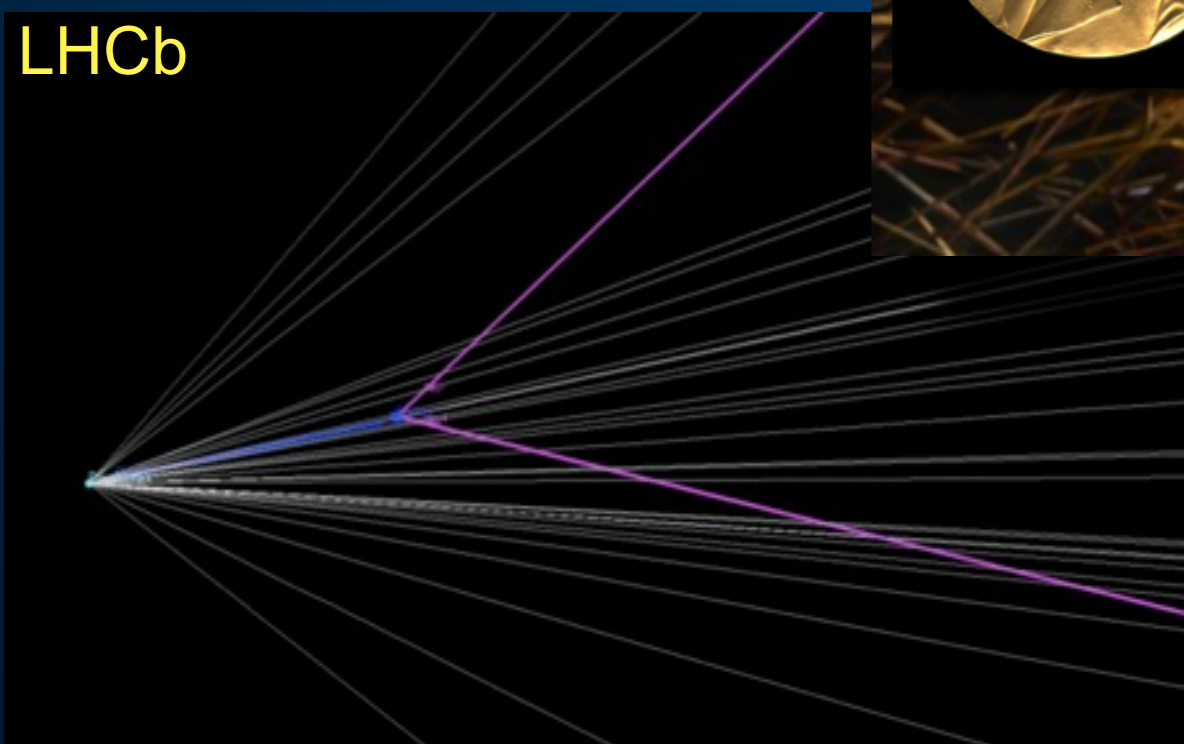
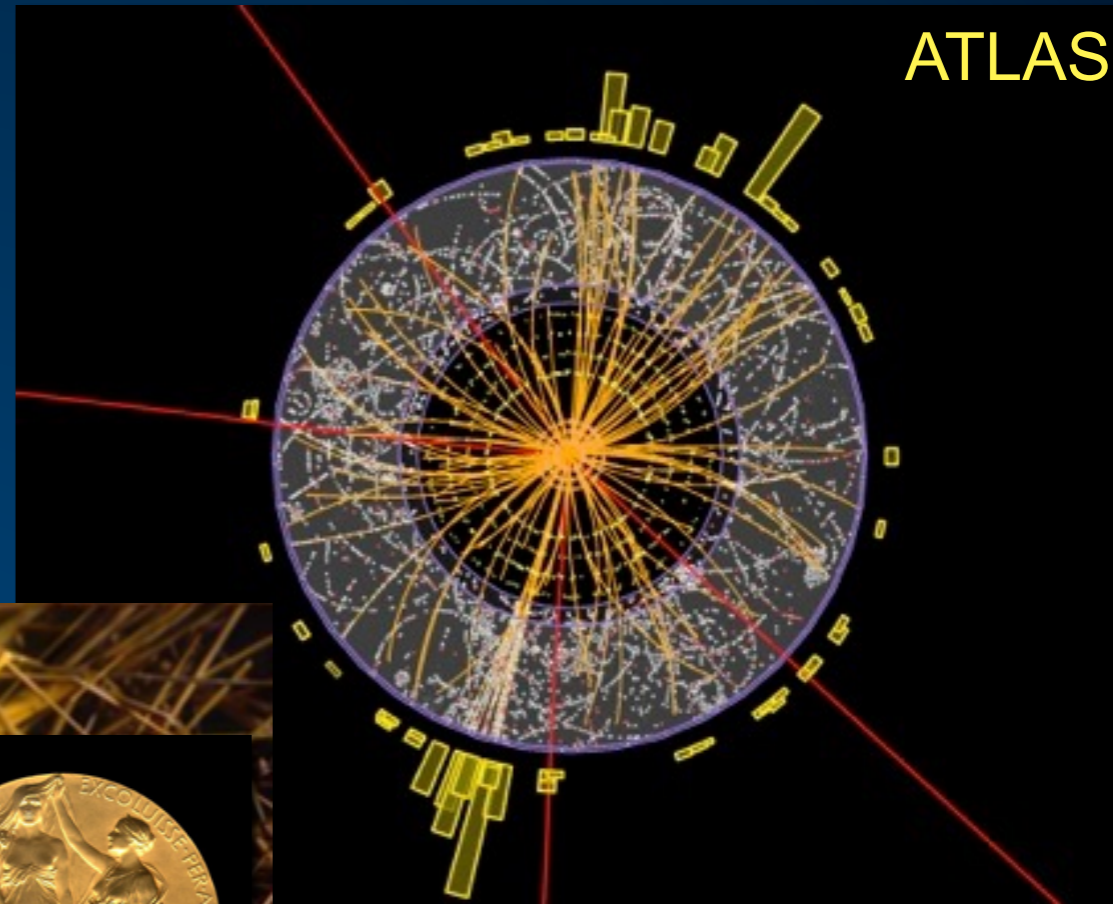
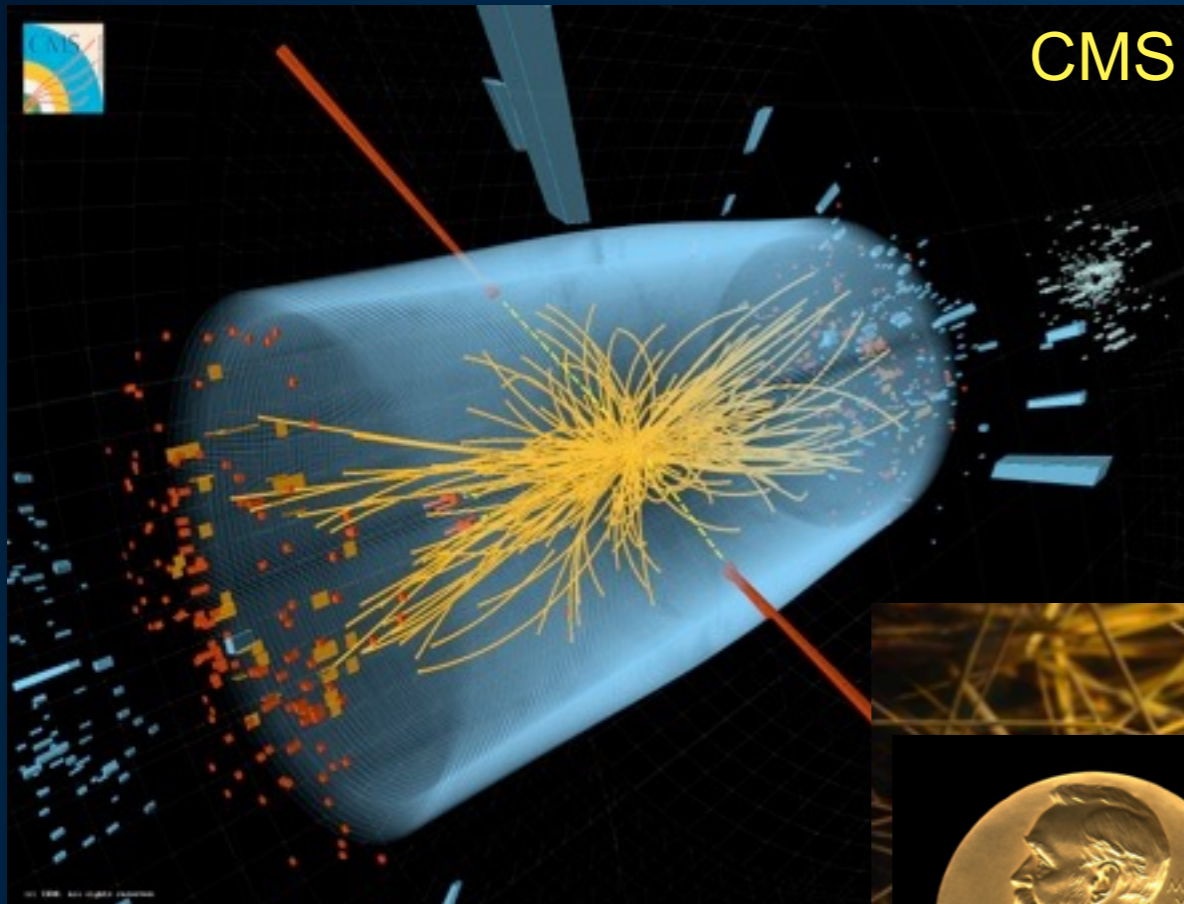

3 Gb/sec - Datenvolumen pro Jahr ~25 Petabytes

**Wozu ?**

# Beispiel: World Wide Web



*interesting, but vague...*



[www.cern.ch](http://www.cern.ch)

vor ~25 Jahren entwickelt:  
nicht vorhersehbar, dass es unsere moderne  
Kommunikationsgesellschaft revolutionieren würde

# Wir bestehen aus Teilchen

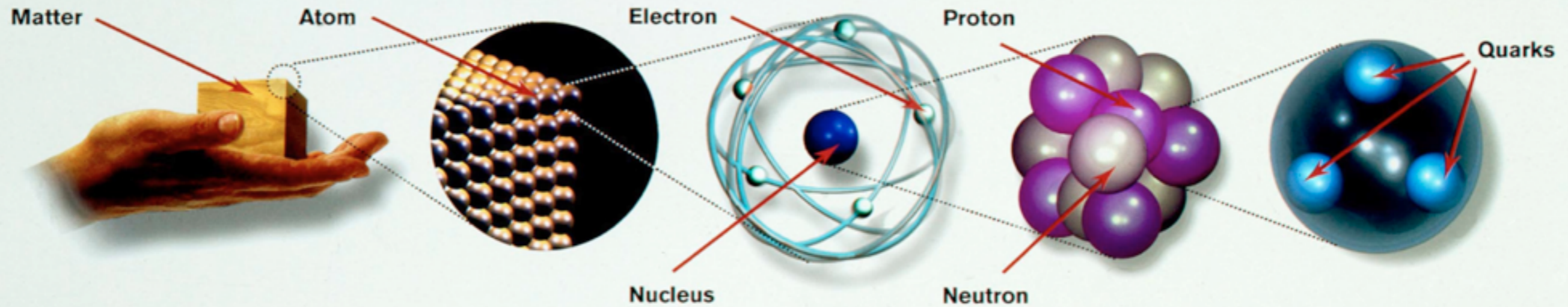

# Wir bestehen aus Teilchen

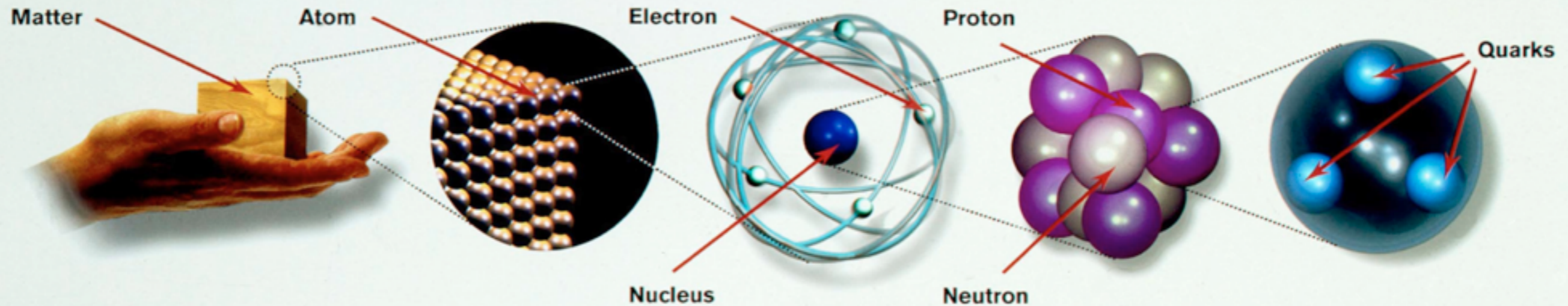

Teilchen interagieren mit anderen Teilchen

werden absorbiert, streuen, modifizieren die Materie

erzeugen messbare Signale



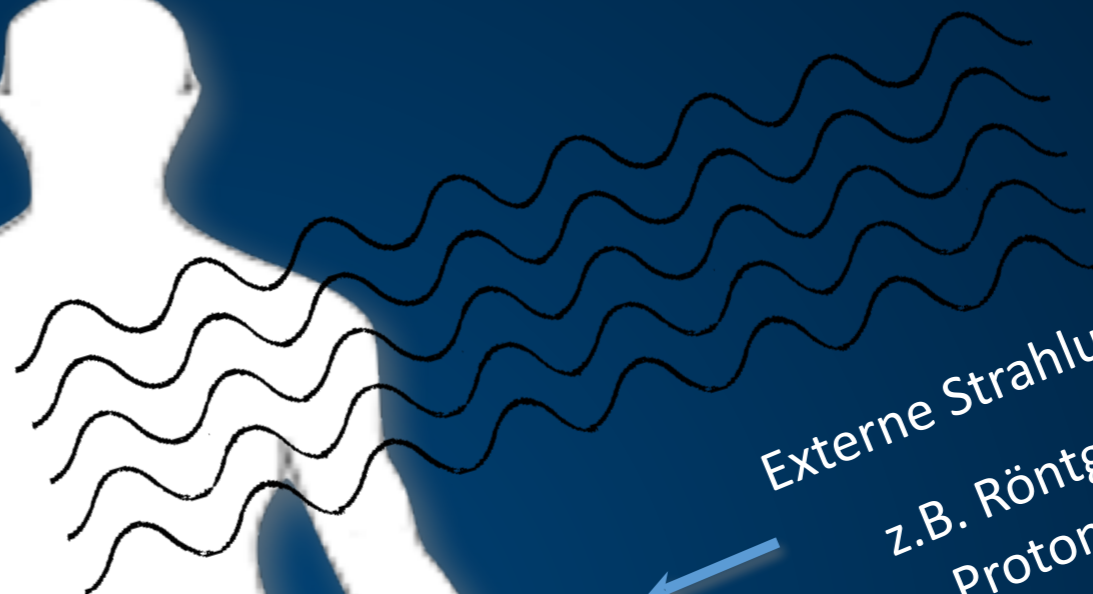
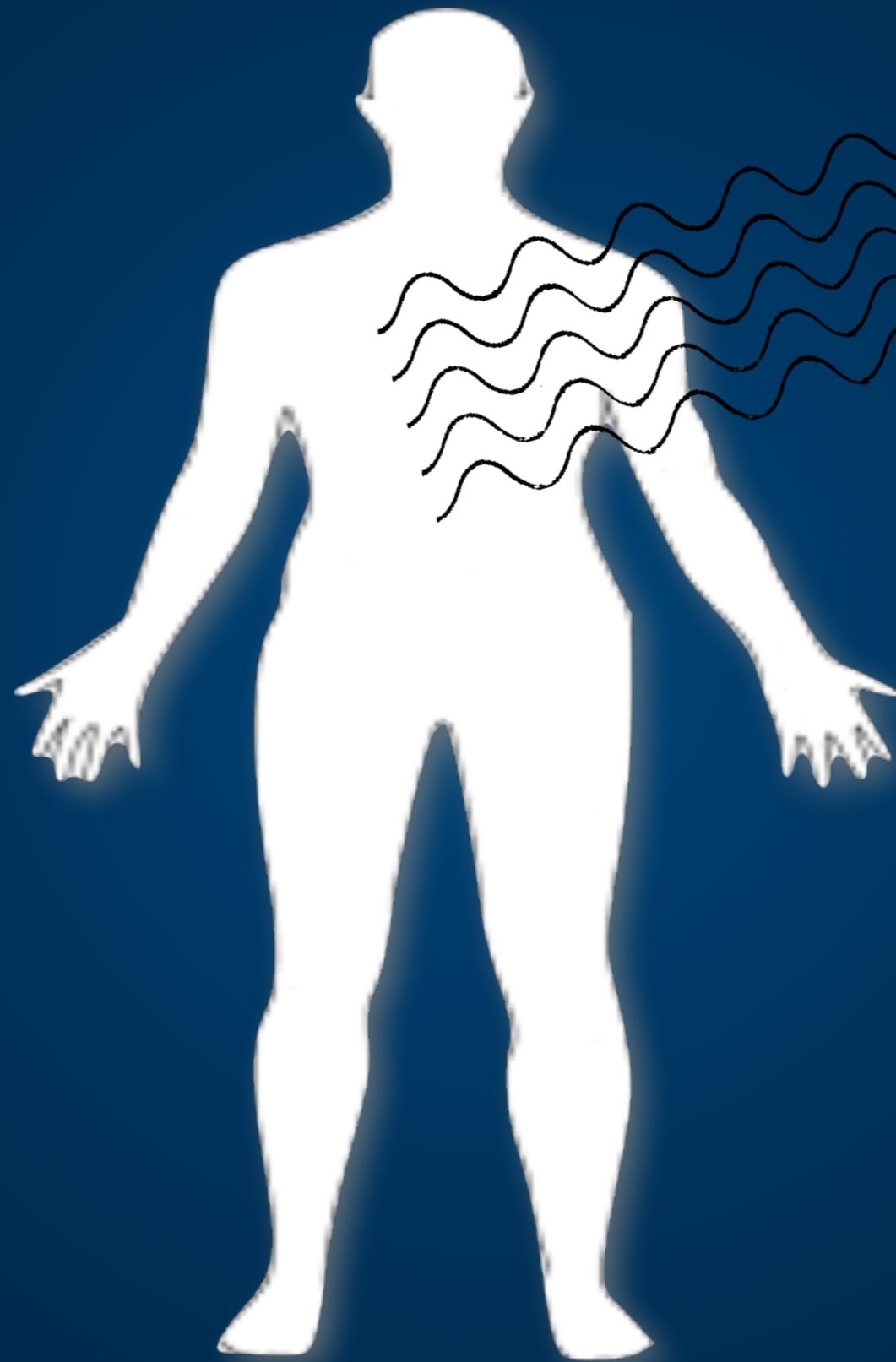

Externe Strahlung (Teilchen),  
z.B. Röntgenstrahlen,  
Protonenstrahlen



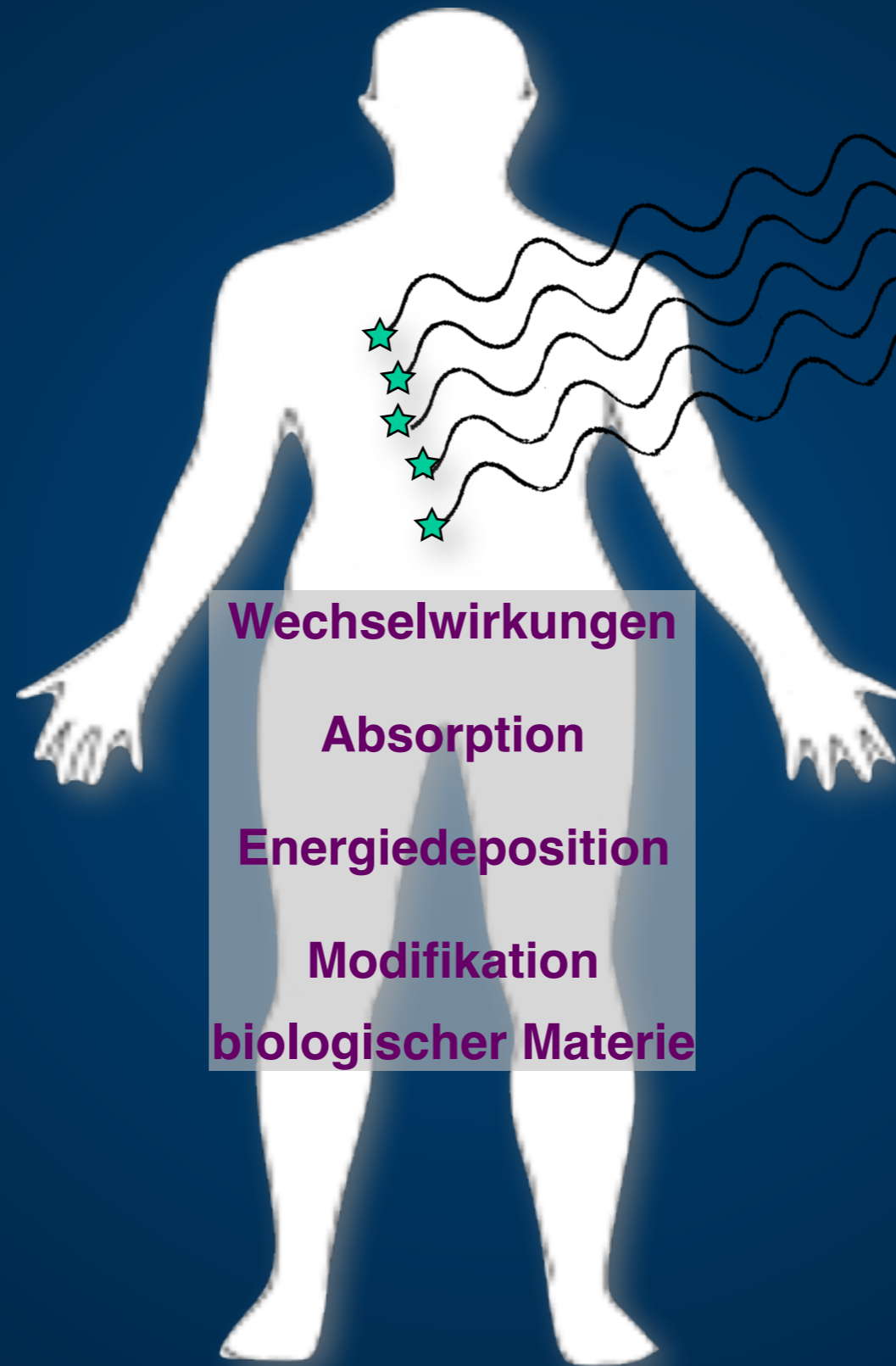

Externe Strahlung (Teilchen),  
z.B. Röntgenstrahlen,  
Protonenstrahlen

**Wechselwirkungen**  
**Absorption**  
**Energiedeposition**  
**Modifikation**  
**biologischer Materie**

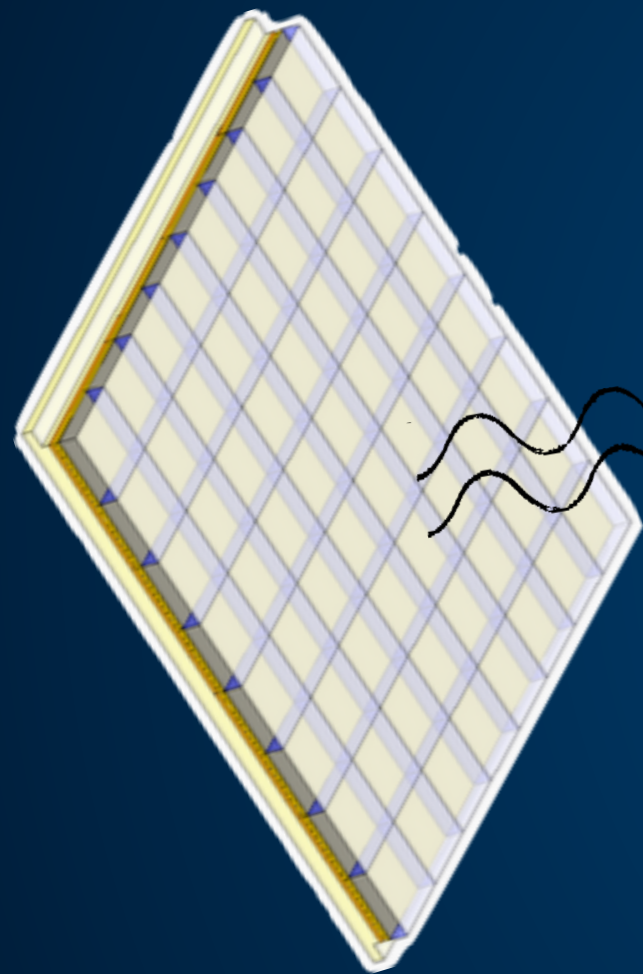

externer Detektor

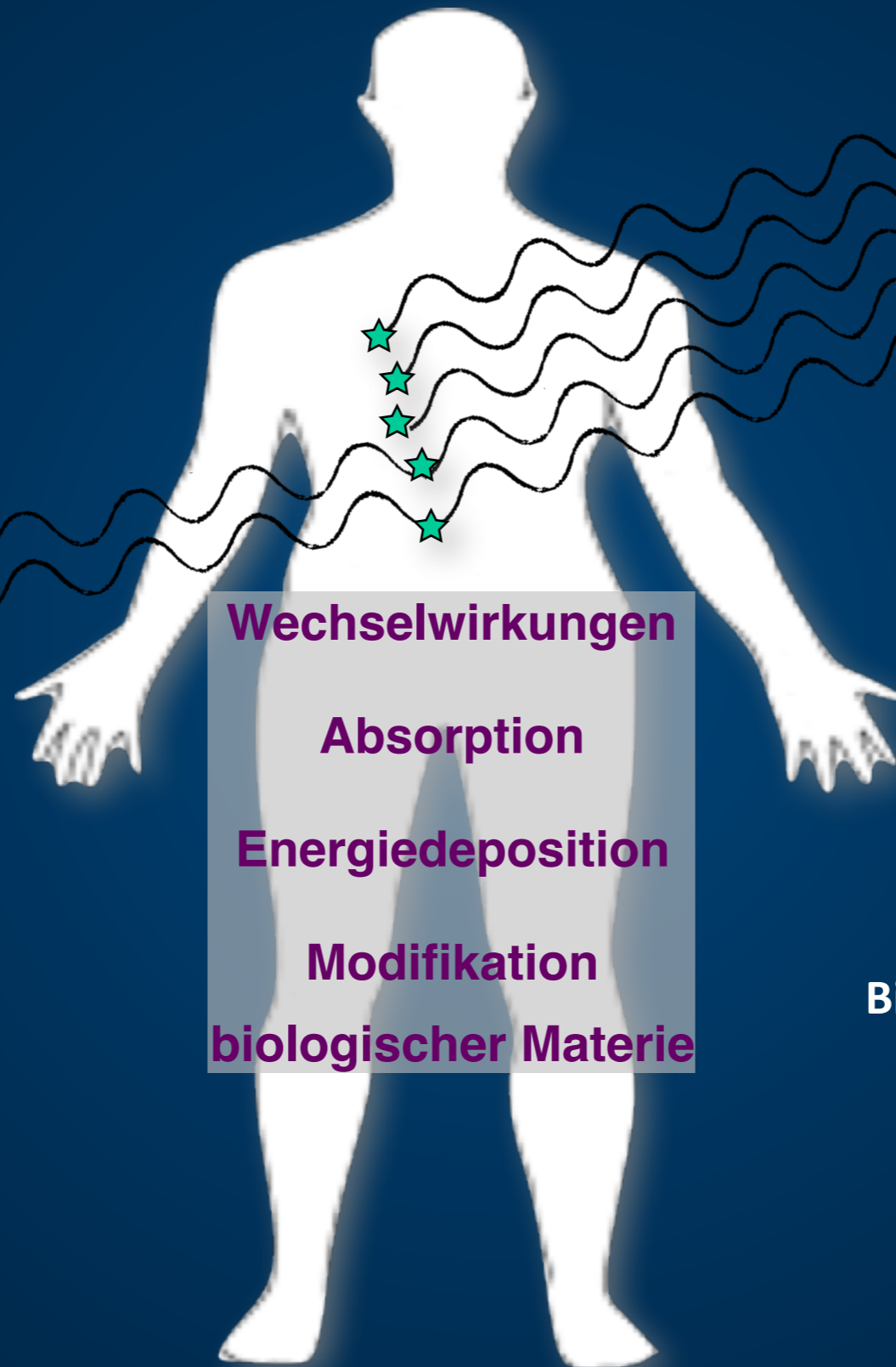

**Wechselwirkungen**  
**Absorption**  
**Energiedeposition**  
**Modifikation**  
**biologischer Materie**

Externe Strahlung (Teilchen),  
z.B. Röntgenstrahlen,  
Protonenstrahlen

**Bildgebung und Krebstherapie mit  
externer Strahlung**

Röntgen, CT,  
Protontherapie





**Injizierter Radiotracer**

**Wechselwirkung**

**Aussendung von**

**Teilchen**

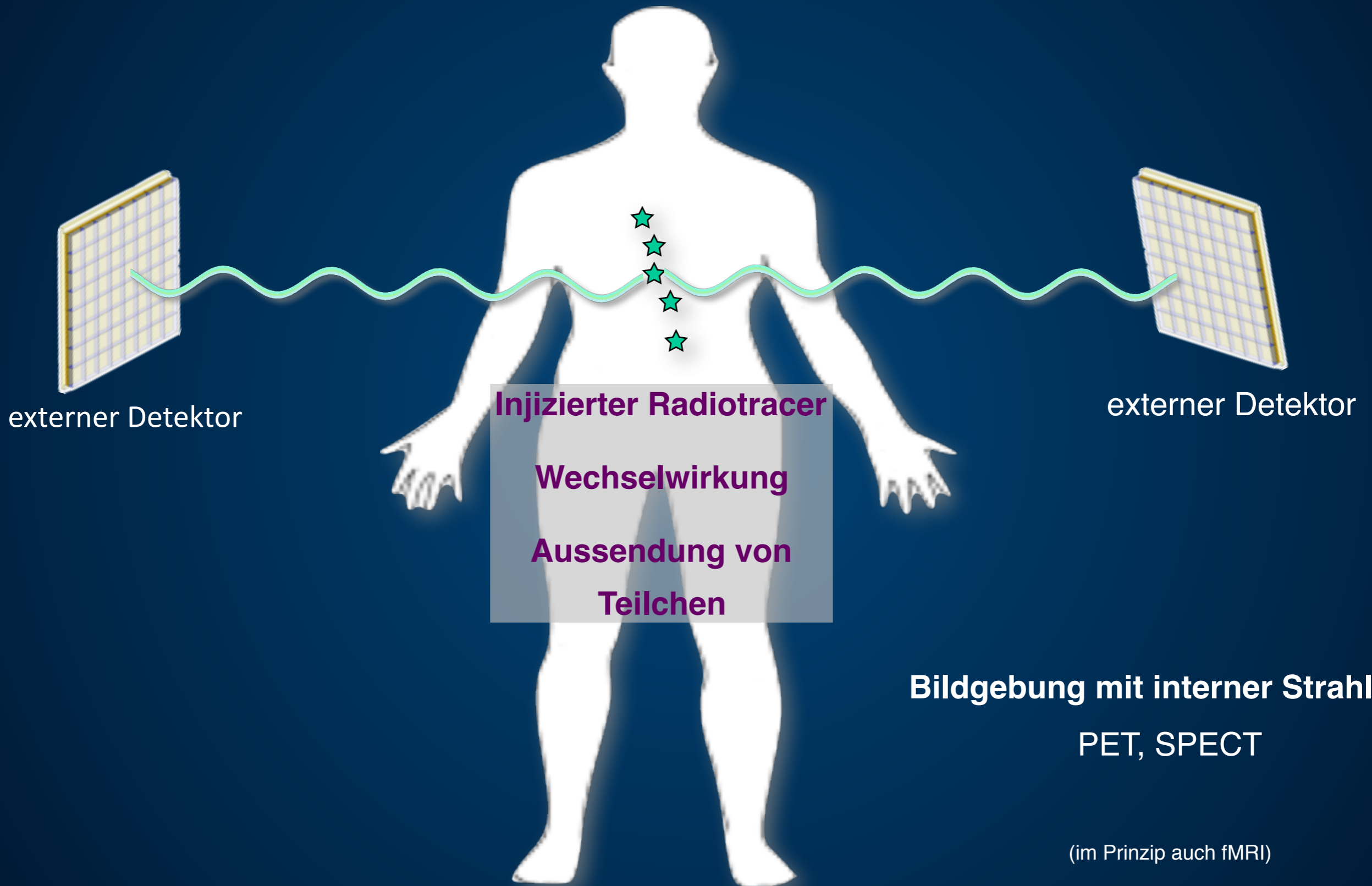

externer Detektor

**Injizierter Radiotracer**

**Wechselwirkung**

**Aussendung von**

**Teilchen**

externer Detektor

**Bildgebung mit interner Strahlung**

**PET, SPECT**

(im Prinzip auch fMRI)

# D.h. Ihr nächster Röntgen-Termin ist ein Teilchenphysik-Experiment!

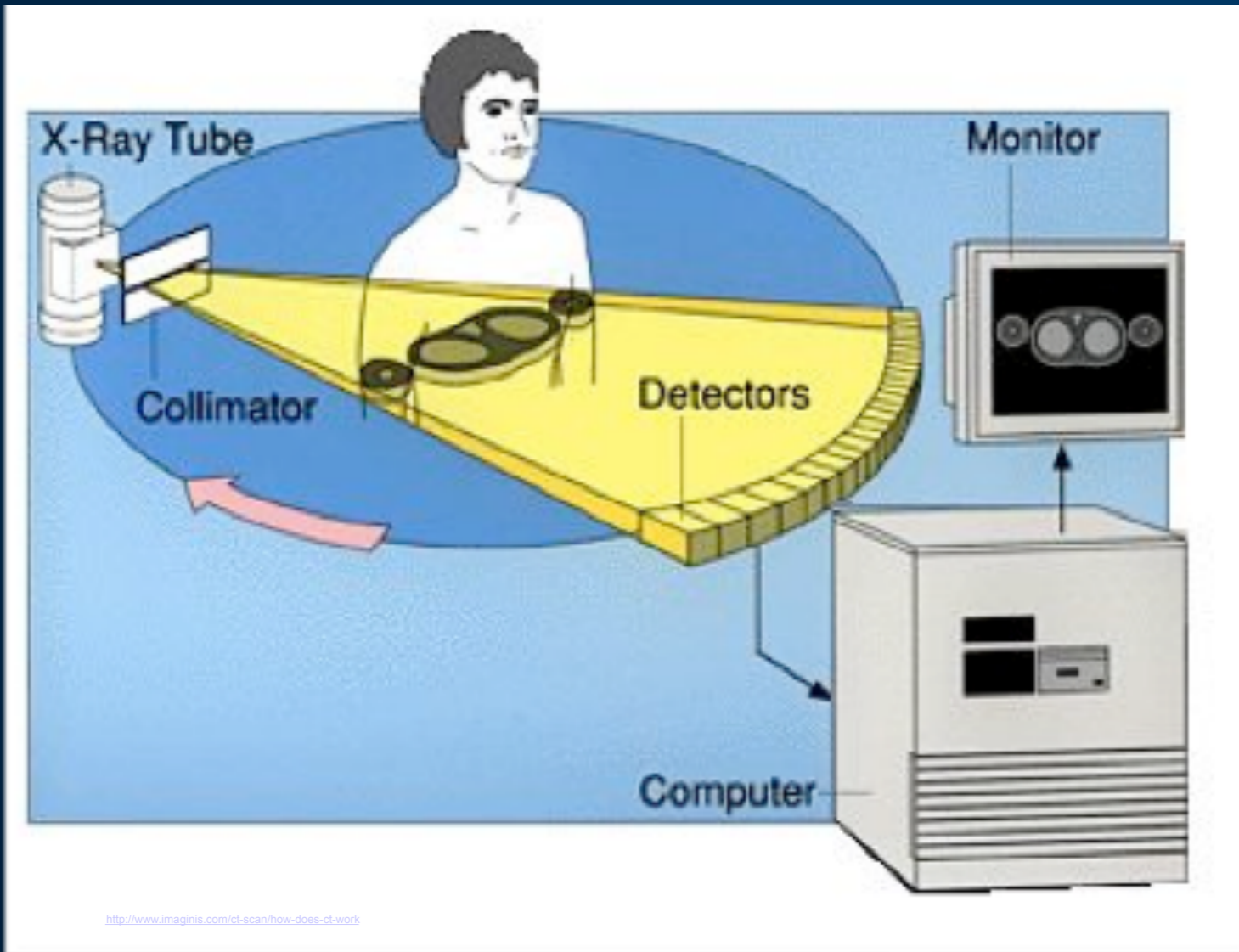
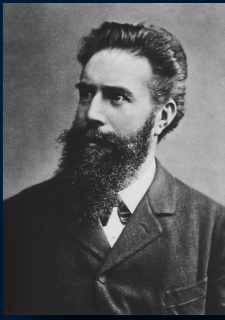

# D.h. Ihr nächster Röntgen-Termin ist ein Teilchenphysik-Experiment!

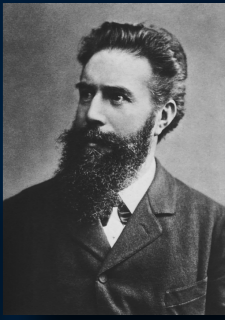

Beschleuniger

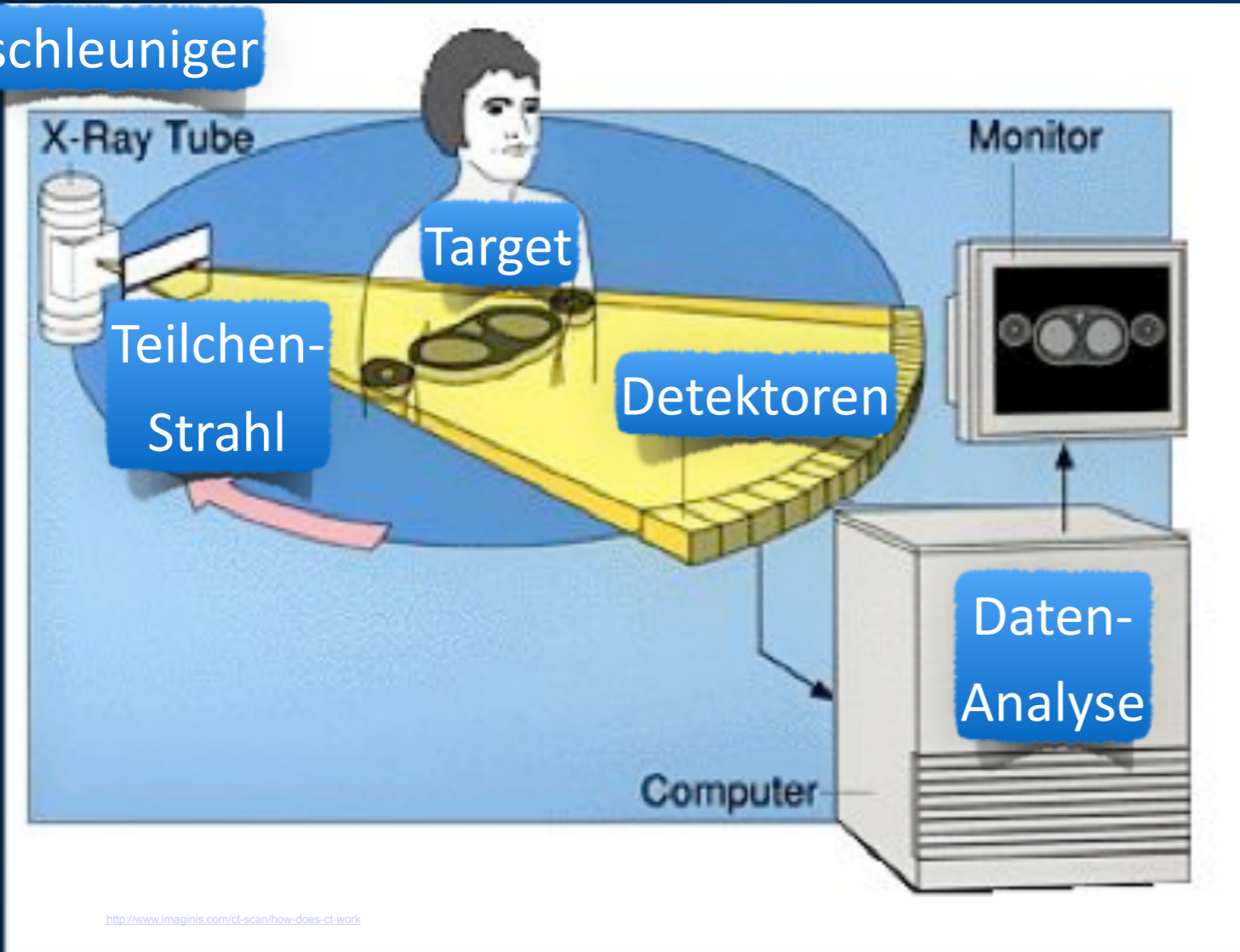

# D.h. Ihr nächster Röntgen-Termin ist ein Teilchenphysik-Experiment!



Beschleuniger

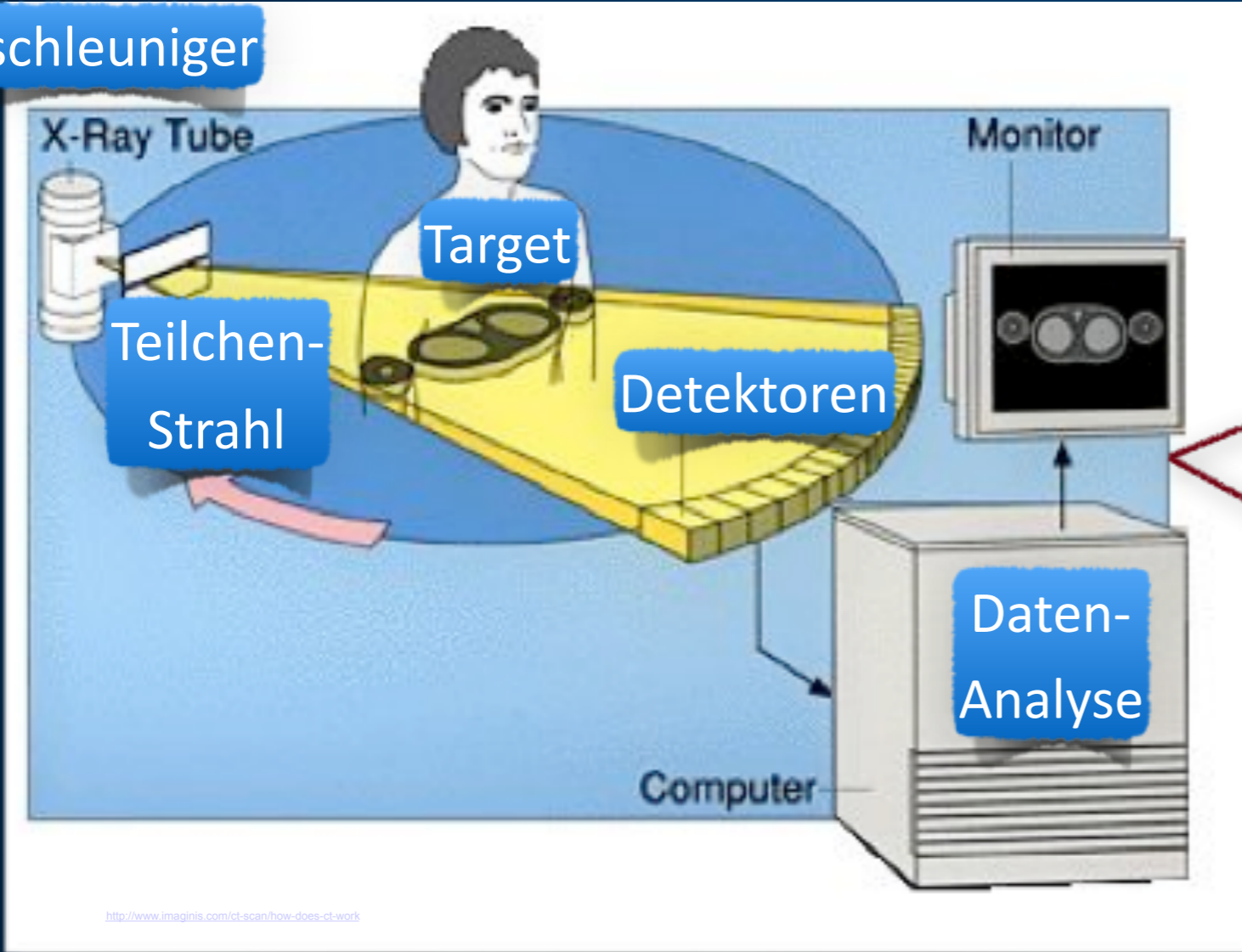

<http://www.imaginis.com/ct-scan/how-does-ct-work>

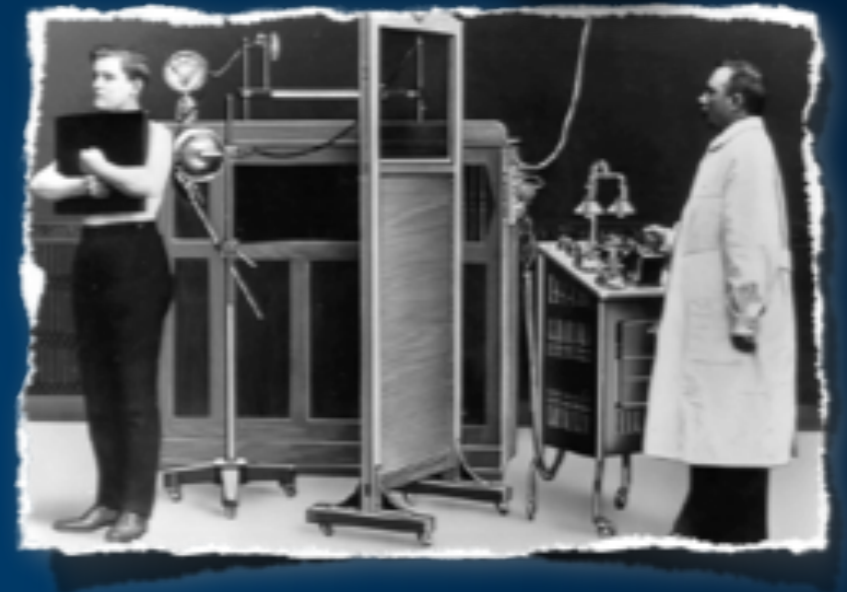



# Hadronen-Therapie

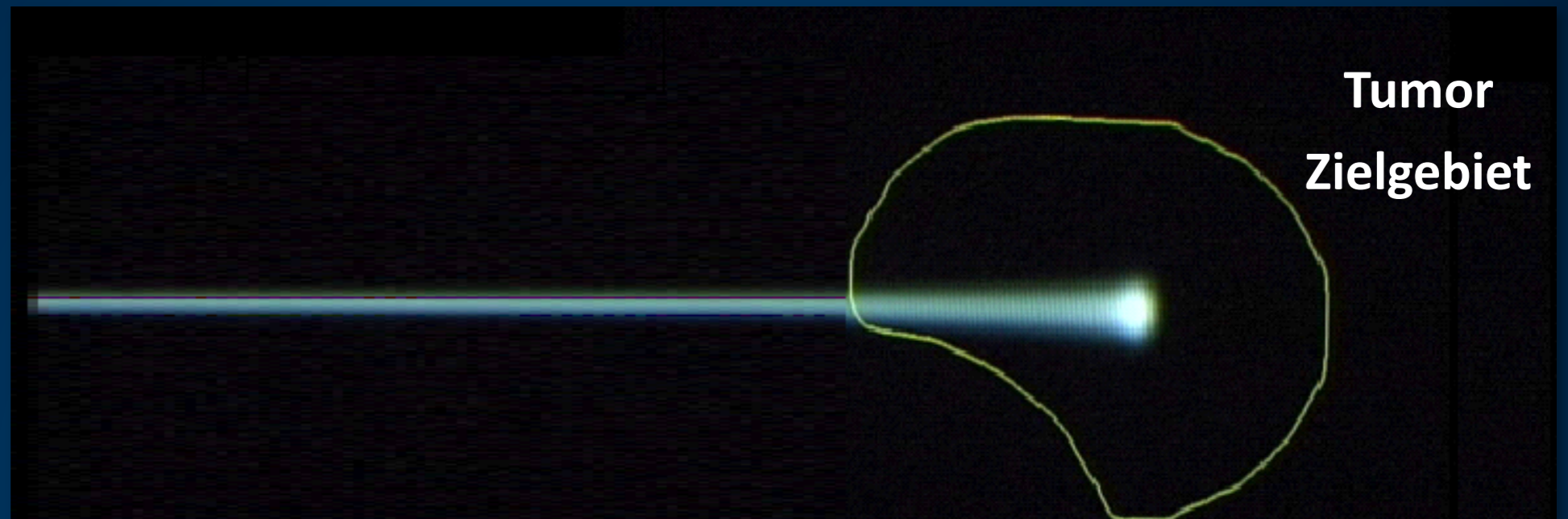

Parrinello, CERN

# Hadronen-Therapie

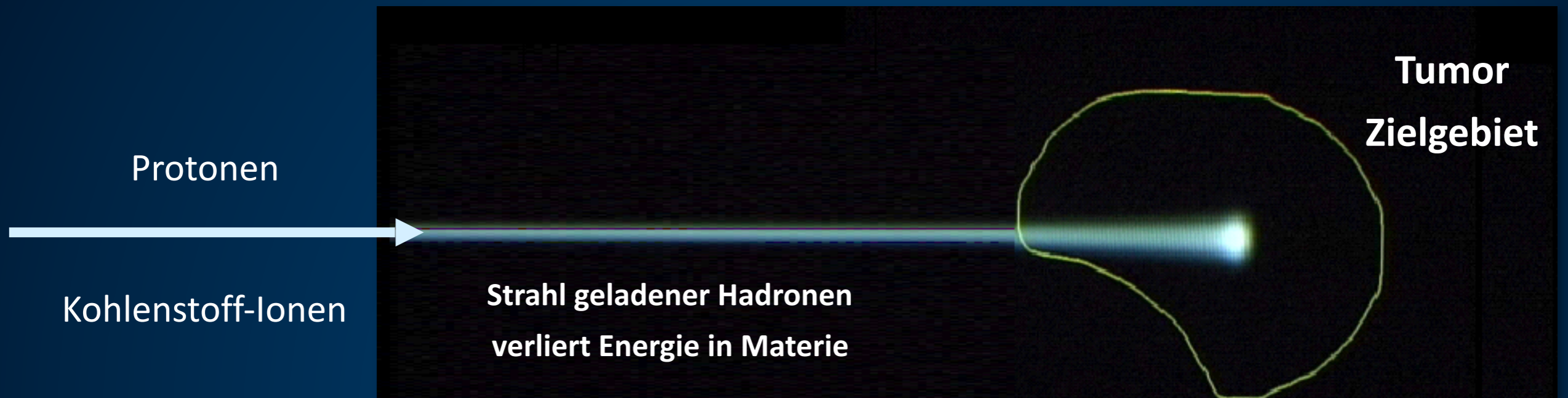

Parrinello, CERN

# Hadronen-Therapie

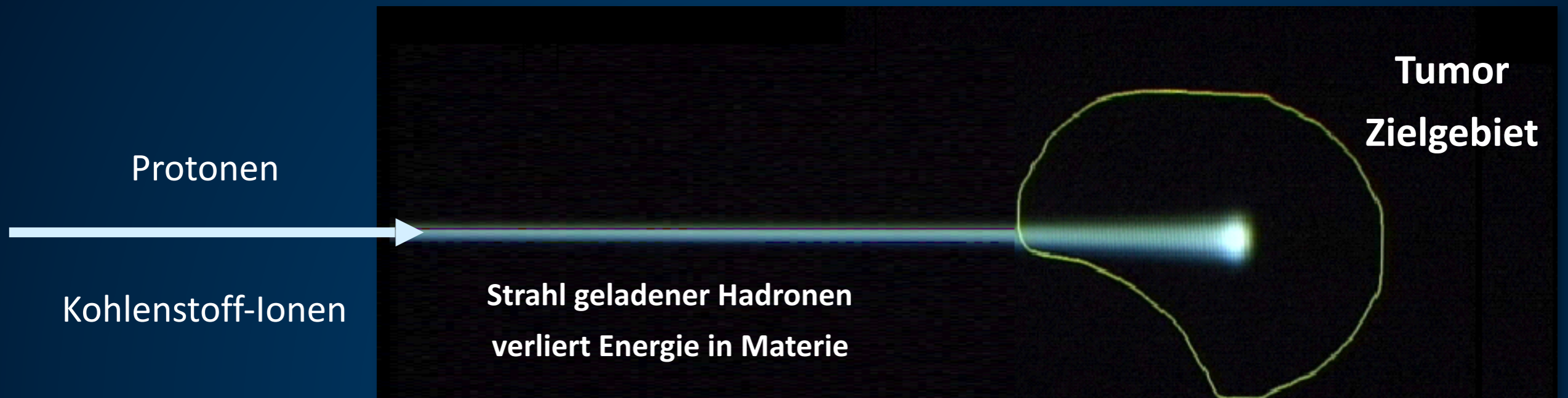

Parrinello, CERN

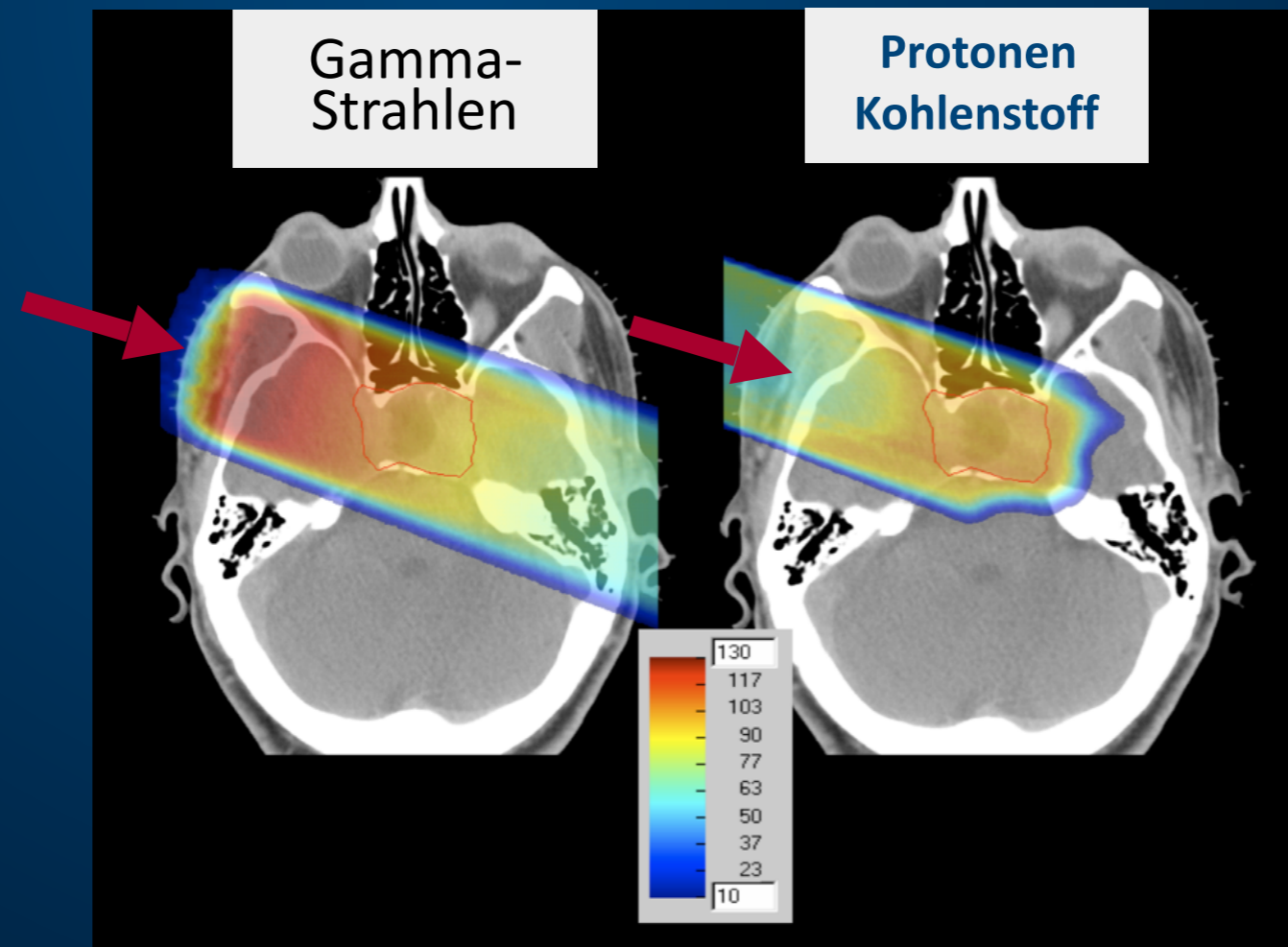

GSI

# Hadronen-Therapie

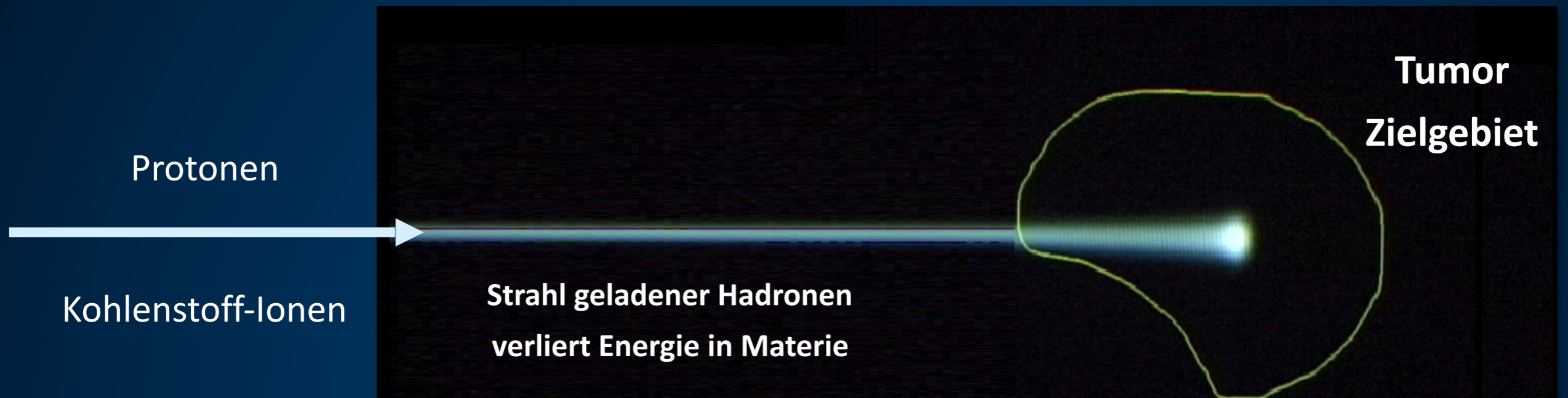

Parrinello, CERN

Erste Idee: Wilson, 1946

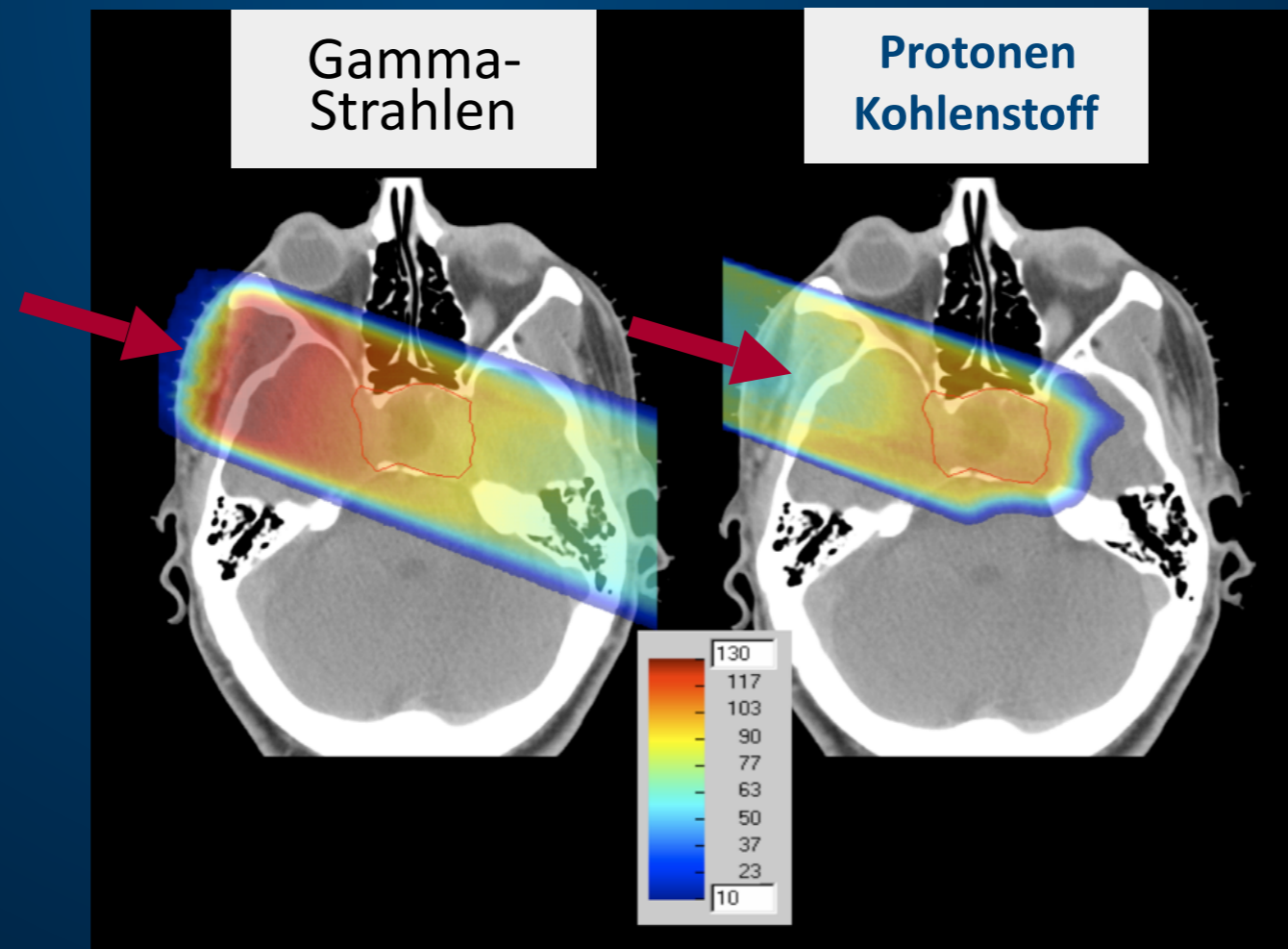

GSI

# Detektoren und Messprinzipien:

## Beispiel Positron-Emissions-Tomographie (PET)

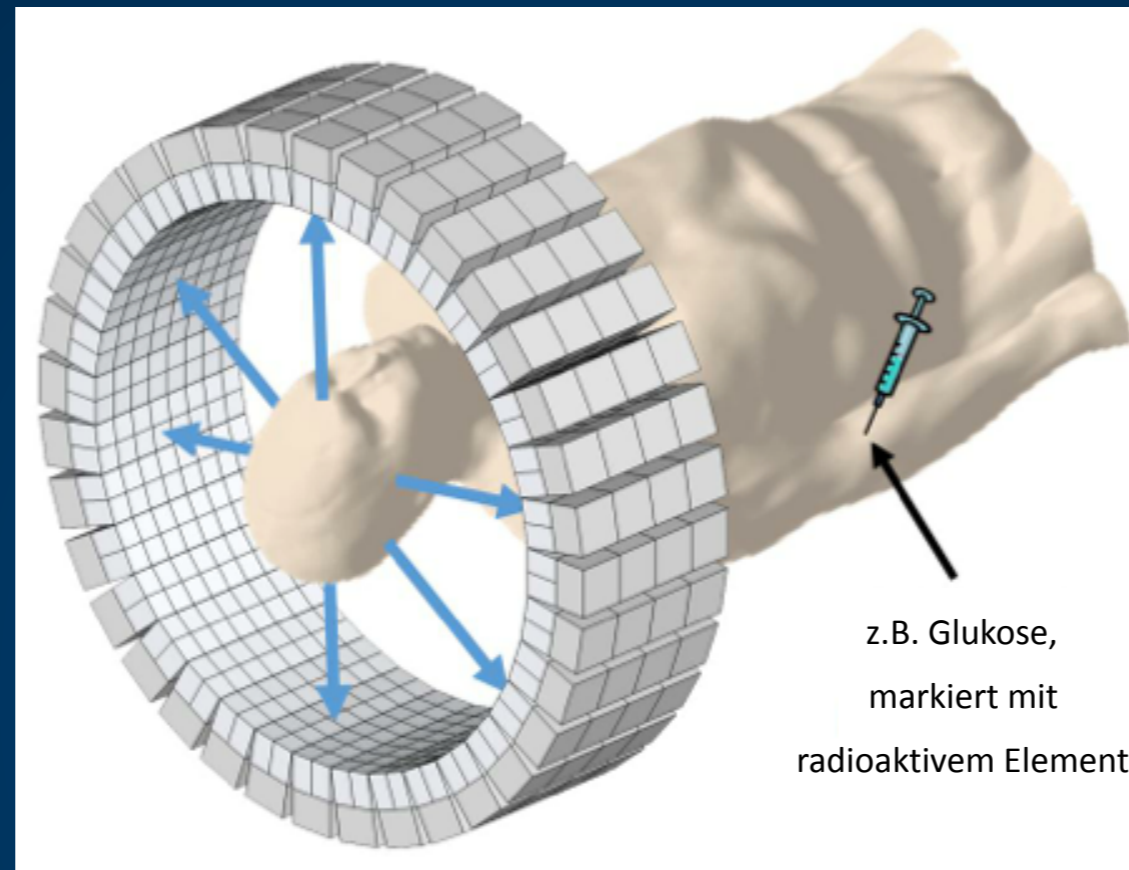

# Detektoren und Messprinzipien:

## Beispiel Positron-Emissions-Tomographie (PET)

$$E = mc^2$$

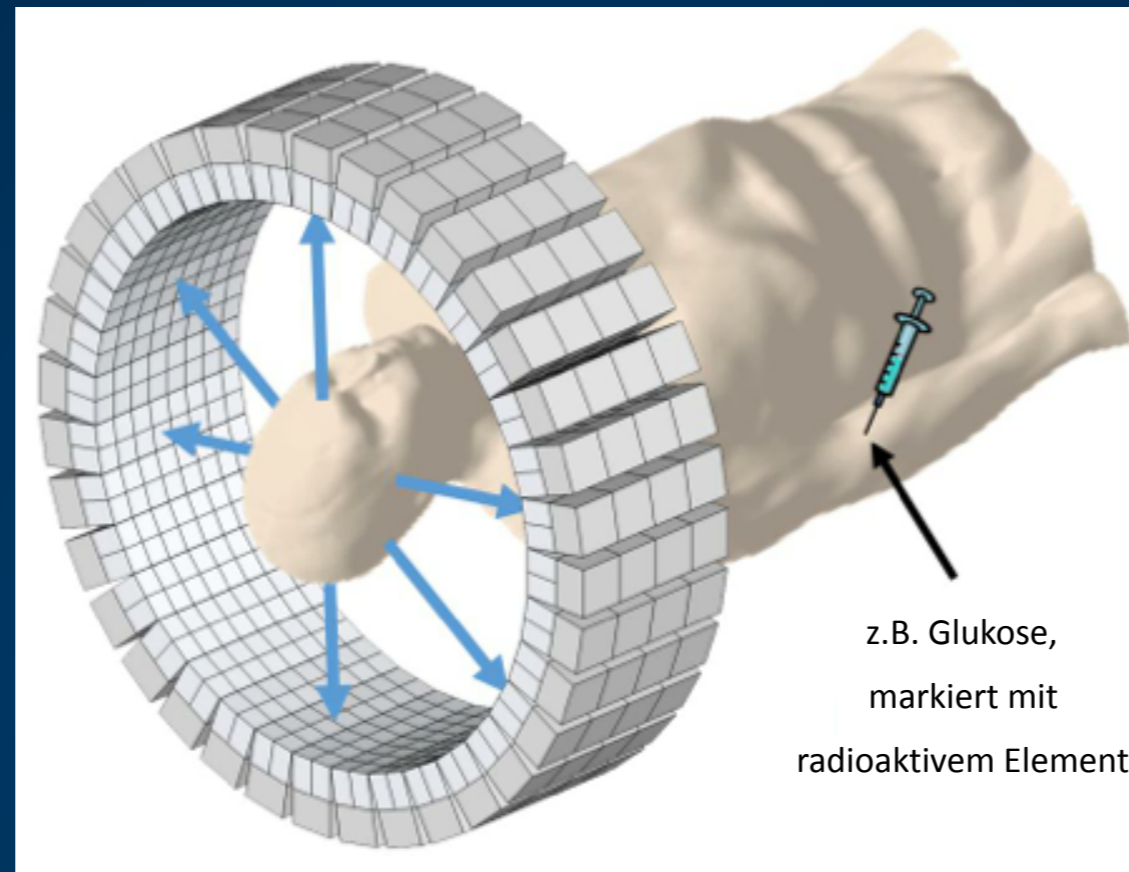

**Anti-  
Materie**

# Detektoren und Messprinzipien:

## Beispiel Positron-Emissions-Tomographie (PET)

$$E = mc^2$$

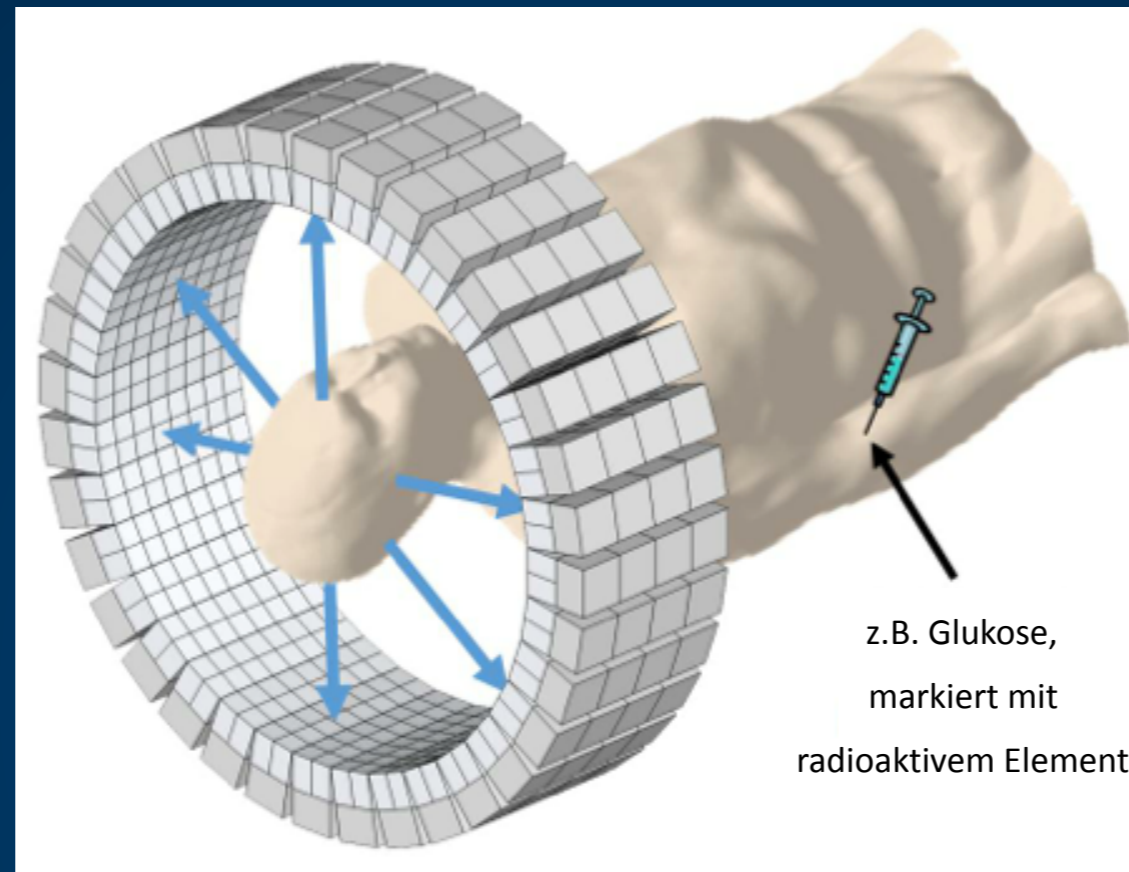

Anti-Materie

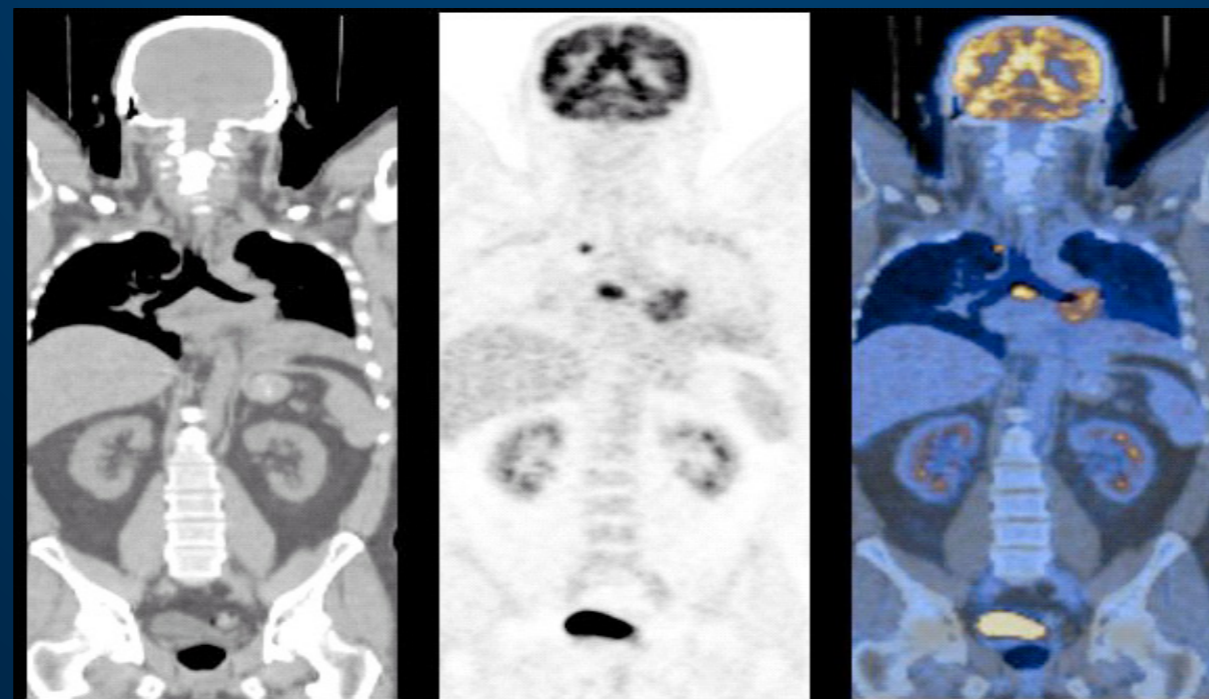

# Fazit

Teilchenstrahlen aus Beschleunigern zur Krebstherapie

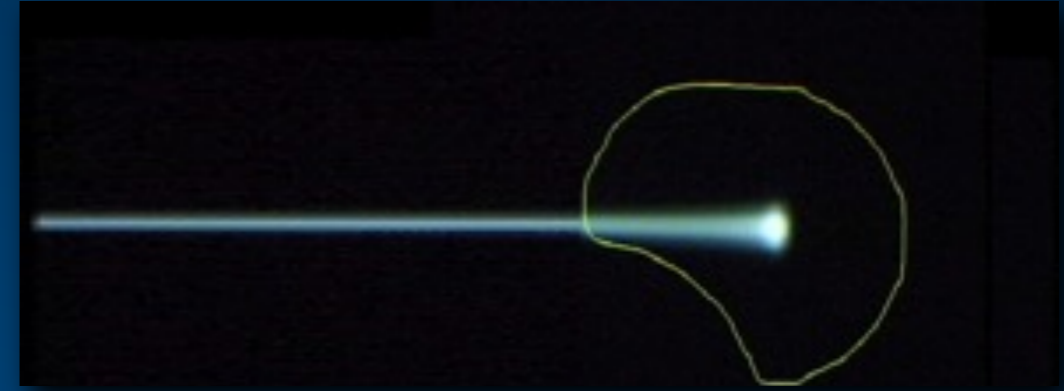



# Fazit

Teilchenstrahlen aus Beschleunigern zur Krebstherapie

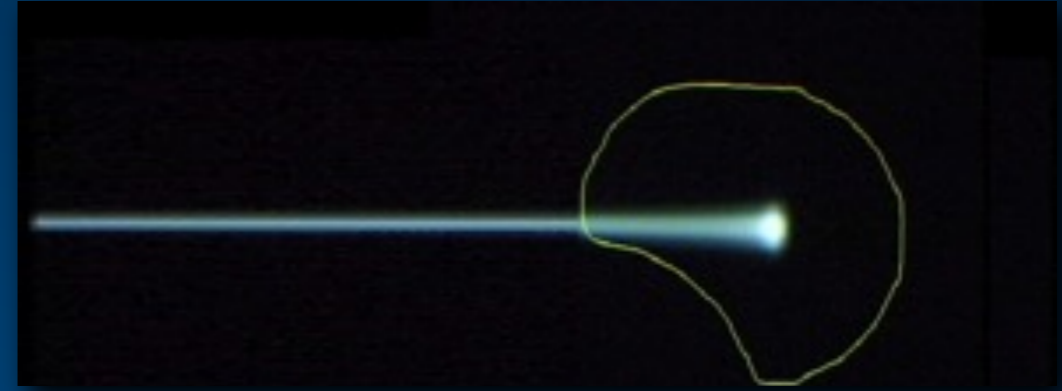

Teilchendetektor-Technologie für (bio-)medizinische Bildgebung

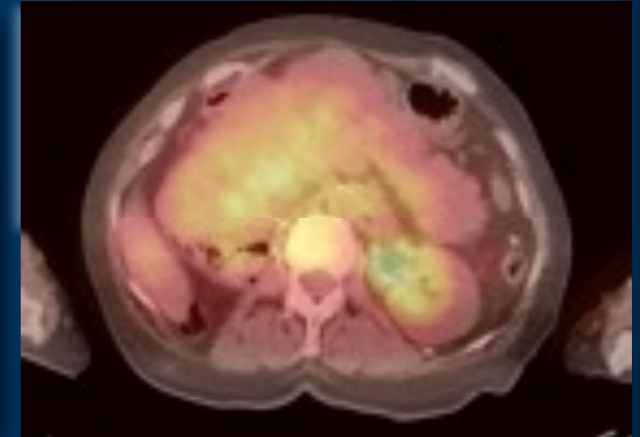
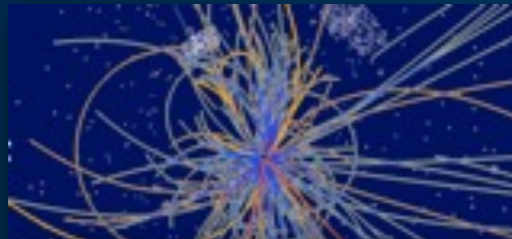

# Fazit

Teilchenstrahlen aus Beschleunigern zur Krebstherapie

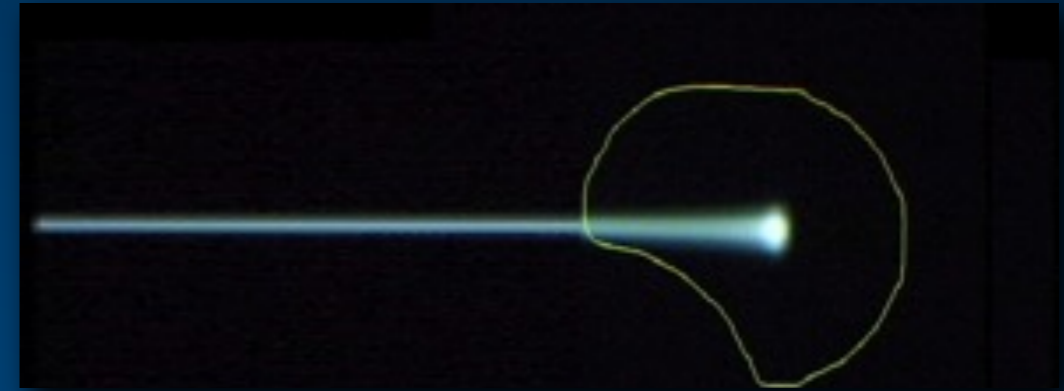

Teilchendetektor-Technologie für (bio-)medizinische Bildgebung

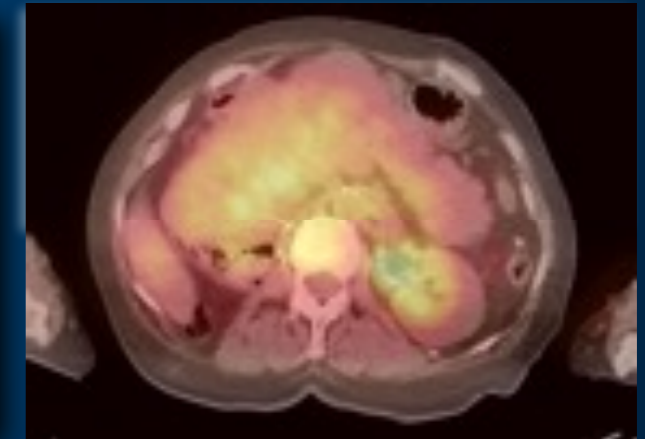
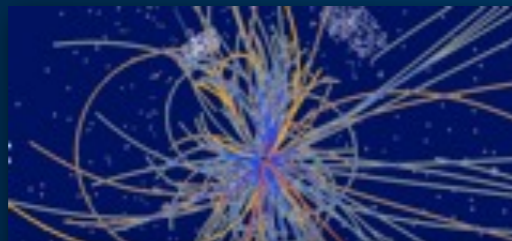

Grid Technologie für medizinische Datenverwaltung und Analyse

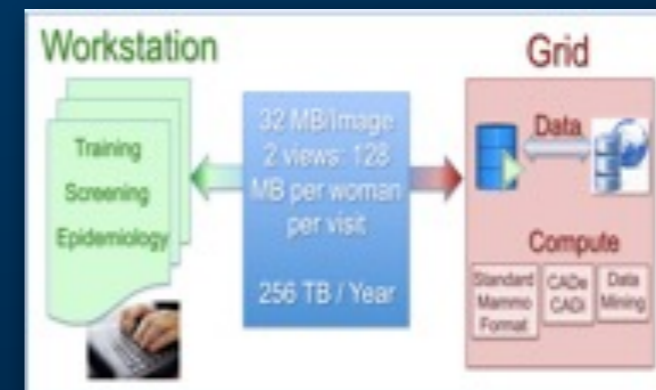

# Noch ein paar Gedanken

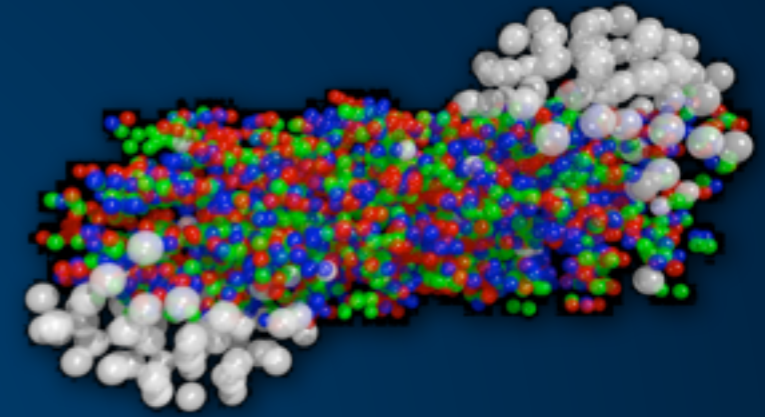

# Noch ein paar Gedanken

- mehr Atome in Ihrem kleinen Finger, als Sterne im gesamten Universum

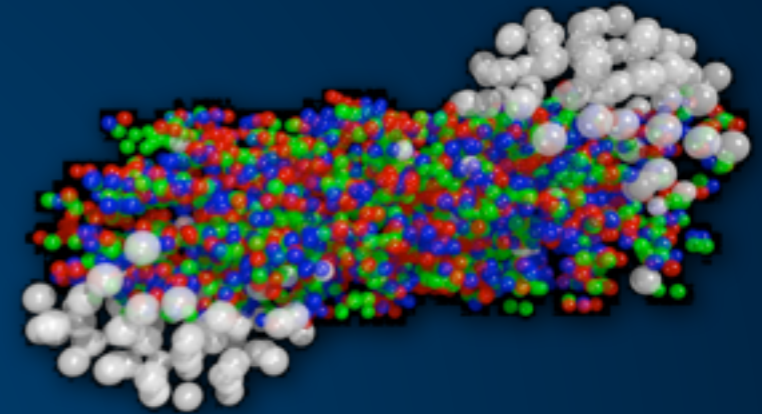

# Noch ein paar Gedanken

- mehr Atome in Ihrem kleinen Finger, als Sterne im gesamten Universum
- wir bestehen aus 13 Milliarden Jahren alten Bausteinen

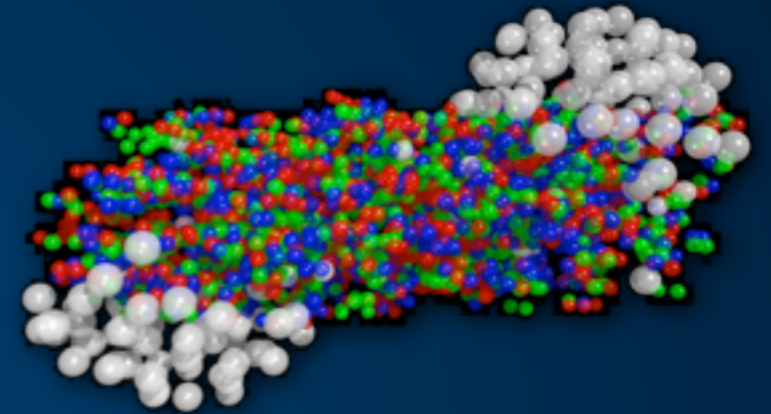

# Noch ein paar Gedanken

- mehr Atome in Ihrem kleinen Finger, als Sterne im gesamten Universum
- wir bestehen aus 13 Milliarden Jahren alten Bausteinen
- wir bestehen aus Sternenstaub

