

Noise properties of an optical frequency comb from a SESAM-mode-locked 1.5- μm solid-state laser stabilized to the 10^{-13} level

S. Schilt, V. Dolgovskiy, N. Bucalovic, C. Schori, M. C. Stumpf, G. Di Domenico, S. Pekarek, A. E. H. Oehler, T. Südmeyer, et al.

Applied Physics B
Lasers and Optics

ISSN 0946-2171
Volume 109
Number 3

Appl. Phys. B (2012) 109:391-402
DOI 10.1007/s00340-012-5072-z

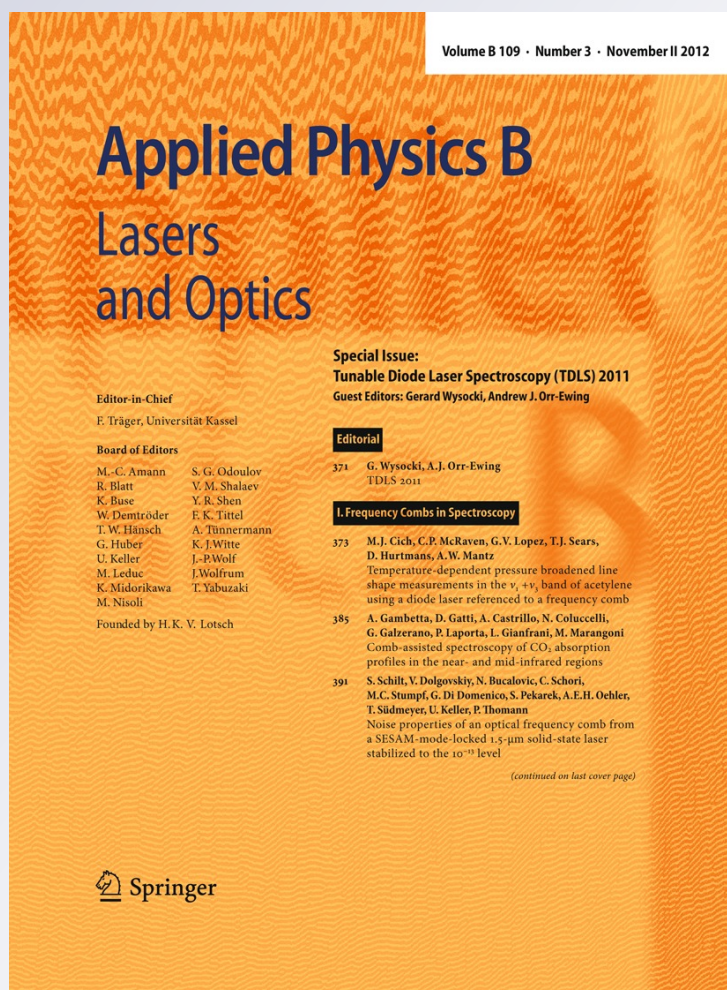

Your article is protected by copyright and all rights are held exclusively by Springer-Verlag. This e-offprint is for personal use only and shall not be self-archived in electronic repositories. If you wish to self-archive your work, please use the accepted author's version for posting to your own website or your institution's repository. You may further deposit the accepted author's version on a funder's repository at a funder's request, provided it is not made publicly available until 12 months after publication.

Noise properties of an optical frequency comb from a SESAM-mode-locked 1.5- μm solid-state laser stabilized to the 10^{-13} level

S. Schilt · V. Dolgovskiy · N. Bucalovic · C. Schori ·
M.C. Stumpf · G. Di Domenico · S. Pekarek ·
A.E.H. Oehler · T. Südmeyer · U. Keller · P. Thomann

Received: 30 November 2011 / Revised version: 12 April 2012 / Published online: 26 May 2012
© Springer-Verlag 2012

Abstract We present a detailed investigation of the noise properties of an optical frequency comb generated from a femtosecond diode-pumped solid-state laser operating in the 1.5- μm spectral region. The stabilization of the passively mode-locked Er:Yb:glass laser oscillator, referred to as ERGO, is achieved using pump power modulation for the control of the carrier envelope offset (CEO) frequency and by adjusting the laser cavity length for the control of the repetition rate. The stability and the noise of the ERGO comb are characterized in free-running and in phase-locked operation by measuring the noise properties of the CEO, of the repetition rate, and of a comb line at 1558 nm. The comb line is analyzed from the heterodyne beat signal with a cavity-stabilized ultra-narrow-linewidth laser using a frequency discriminator. Two different schemes to stabilize the comb to a radio-frequency (RF) reference are compared. The comb properties (phase noise, frequency stability) are limited in both cases by the RF oscillator used to stabilize the repetition rate, while the contribution of the

CEO is negligible at all Fourier frequencies, as a consequence of the low-noise characteristics of the CEO-beat. A linewidth of ≈ 150 kHz and a fractional frequency instability of 4.2×10^{-13} at 1 s are obtained for an optical comb line at 1558 nm. Improved performance is obtained by stabilizing the comb to an optical reference, which is a cavity-stabilized ultra-narrow linewidth laser at 1558 nm. The fractional frequency stability of 8×10^{-14} at 1 s, measured in preliminary experiments, is limited by the reference oscillator used in the frequency comparison.

1 Introduction

Optical frequency combs from mode-locked femtosecond lasers have revolutionized the field of frequency metrology by providing a direct, phase-coherent link between optical and microwave frequencies and by allowing an optical frequency to be measured with extreme precision in terms of the unit of time of the international system of units [1, 2]. This has led to the development of new generations of optical atomic clocks with a stability unreachable with microwave clocks [3, 4]. Besides their primary use in time and frequency metrology, optical frequency combs have found alternative applications in high resolution spectroscopy owing to their unique properties. They constitute a versatile spectroscopic tool that combines an excellent accuracy (the frequency of each comb line can be determined with a very high precision), a high spectral purity (each comb line has a narrow linewidth ranging down to the hertz level when the comb is stabilized to an optical reference [5]), and at the same time a broad spectral coverage, allowing spectroscopy to be performed over an octave spectrum with a single laser source [6]. The tremendous number of comb lines simultaneously available opens new perspectives for broadband

S. Schilt (✉) · V. Dolgovskiy · N. Bucalovic · C. Schori ·
M.C. Stumpf · G. Di Domenico · T. Südmeyer · P. Thomann
Laboratoire Temps-Fréquence, Université de Neuchâtel,
Avenue de Bellevaux 51, 2000 Neuchâtel, Switzerland
e-mail: stephane.schilt@unine.ch
Fax: +41-32-7182901

M.C. Stumpf · S. Pekarek · A.E.H. Oehler · T. Südmeyer ·
U. Keller
Department of Physics, Institute of Quantum Electronics,
ETH Zurich, 8093 Zurich, Switzerland

Present address:
M.C. Stumpf
RUAG Space, RUAG Schweiz AG, 8052 Zurich, Switzerland

Present address:
A.E.H. Oehler
Time Bandwidth Products AG, 8005 Zurich, Switzerland

high resolution spectroscopy analysis, but also requires new sophisticated tools to extract the spectroscopic information corresponding to each individual comb line. Different approaches have been reported to date with impressive results in terms of performances:

- In a first approach, the spectroscopic information corresponding to a spectrally narrow set of comb lines [7], or even to individual comb lines [8], was obtained by using a dispersive component followed by a multi-element photodetector. With this set-up, a large number of wavelength channels were simultaneously recorded from the dispersed comb spectrum. As an example, Thorpe et al. used a diffraction grating combined to a large photodiode array to simultaneously record 340 ring-down times in broadband cavity ring-down spectroscopy [7]. The resolving power of the grating was insufficient to detect the individual modes of the frequency comb, so that each detector element captured ≈ 60 comb modes corresponding to a spectral resolution of 25 GHz. A much better resolution was achieved by simultaneously using two spectrally dispersive elements, i.e. a diffraction grating orthogonal to a virtually imaged phased array (VIPA) disperser, to split the comb spectrum into a two-dimensional array imaged onto a digital camera, allowing the detection of individual comb lines [6, 8, 9]. These lines can be accurately tuned by scanning the comb repetition rate or the offset frequency to perform high resolution molecular spectroscopy. The first implementation of this method was reported by Diddams et al. using direct absorption spectroscopy [8] and later on by Thorpe et al. in combination with a resonant cavity in cavity-enhanced frequency comb spectroscopy [9].
- Mode-locked lasers have also been used as an efficient light source in combination with a Fourier transform interferometer [10–14] to record absorption spectra of various molecules in the near-infrared (NIR) and mid-infrared (MIR) spectral regions. Compared to traditional tungsten lamps commonly used in absorption Fourier-transform spectrometers, mode-locked lasers simultaneously provide a high sensitivity, a high resolution, and the absolute frequency accuracy of the measured spectral lines, thus enabling to achieve performances that are unreachable by traditional Fourier-transform interferometers. The advantage of frequency comb Fourier transform spectroscopy arises from the high brightness of the femtosecond laser compared to traditional light sources used in Fourier transform spectrometers, as well as from the possibility to detect the interferogram at the comb repetition rate (> 100 MHz) instead of an audio frequency (typ. 10 kHz) providing several orders of magnitude $1/f$ noise reduction [10]. Such an approach has been first applied in the MIR range based on optical parametric oscillators (OPO) [11, 12] or $\text{Cr}^{2+}:\text{ZnSe}$ mode-locked lasers [13]

and later on with a NIR Er: fiber laser [14] or a $\text{Cr}^{4+}:\text{YAG}$ laser [10]. The method can be implemented with commercially available Fourier transform spectrometers leading to an increase in sensitivity of several orders of magnitude [10]. With some modifications of the interferometer electronics, the method also allows for the simultaneous measurement of the absorption and dispersion spectra of the analyzed sample [10]. The combined use of an auto-balancing detection scheme led to shot-noise limited absorption sensitivity [14].

- More recently, a dual-comb Fourier-transform spectroscopy technique has been proposed, in which two independent frequency combs with slightly detuned repetition frequencies, generate an interferogram which is Fourier-transformed to reveal an image of the optical absorption spectrum of an analyzed species, down-converted in the radio-frequency domain [15–18]. This motionless, new type of Fourier transform spectroscopy provides absorption spectra with a much higher resolution and in a much shorter acquisition time than traditional Fourier transform infrared spectrometers. Furthermore, the detection is performed using a single detector, without any need for a detector array nor for massively parallel recording and processing. This makes the method also applicable in the MIR spectral region [19].
- A last type of application of frequency combs in high resolution spectroscopy benefits from only one feature of the comb, the high frequency accuracy of its modes, but not from its broadband detection capability. A laser referenced to a frequency comb is precisely tuned through a molecular transition by scanning the comb repetition rate or the offset frequency. Such an approach was used for the determination of spectroscopic parameters of NIR molecular transitions with an unprecedented accuracy [20], as well as for MIR spectroscopy in combination with a quantum cascade laser and a sum- or difference-frequency generation process [21, 22]. Finally, it was also applied to ultra-sensitive gas sensing in the MIR [23].

For further improvement of the detection sensitivity achieved in the different aforementioned comb spectroscopy methods, the use of absorption enhancing techniques, such as a multipass cell [24] or an external cavity [7, 9, 14, 17, 25] is worth to be mentioned. However, the use of high-finesse external cavities puts severe low frequency noise requirements on the frequency comb, which is a motivation for the development of more stable frequency comb sources as reported in this paper.

The first self-referenced optical frequency combs were based on solid state Ti:sapphire lasers. They provide high peak powers [26, 27] and played an important role in the first developments of direct frequency comb spectroscopy [7–9, 16]. Later on, simpler and cost-effective Er-fiber combs in the 1.5- μm region have been developed and

self-referenced [28]. The octave-spanning spectrum of Er-fiber combs, achieved by spectral broadening in a highly nonlinear fiber, covers the range of 1–2 μm , an important window for molecular overtone spectroscopy. Therefore, these combs have become very attractive for broadband molecular spectroscopy in the past years [6, 9, 18, 20–23]. More recently, new NIR comb technologies have been developed and self-referenced, based on different femtosecond laser sources, such as Cr:forsterite centered at 1275 nm [29], and Yb-fiber [30] or Yb:KYW [31] in the 1- μm spectral region. These combs may open up new wavelengths ranges to comb spectroscopy. Furthermore, MIR combs, which are attractive for broadband molecular spectroscopy in the fundamental fingerprint spectral region, have also been demonstrated based on different principles, such as directly from a 1950-nm Thulium fiber laser [32], by difference frequency generation [33–35], from an OPO [36, 37] or using a crystalline MgF_2 micro-resonator [38].

The so-called ERGO [39] comb, generated from a femtosecond mode-locked Er:Yb:glass laser oscillator, represents an attractive alternative to Er:glass fiber combs in the 1.5- μm spectral region. This frequency comb was primarily developed for optical frequency metrology, in particular for ultra-stable microwave generation [41, 42], but alternative applications in high resolution spectroscopy may be foreseen in the future. In this paper, we present a detailed analysis of the noise properties of the ERGO frequency comb. This work complements previous publications that described the generation and detection of the carrier envelope offset (CEO) beat in the ERGO comb [44], followed by the recent demonstration of the full frequency stabilization of this comb [40]. Compared to this later publication, we present here much more details of the experimental methods used to characterize the comb noise properties. We also show the much lower frequency noise measured for the CEO beat in the ERGO comb compared to a commercial Er:glass fiber comb. Finally, the frequency noise of the repetition rate is shown as well as the noise of an optical comb line obtained when the comb was locked to two different RF oscillators, followed by first results of the stabilization of this comb to an optical reference.

2 ERGO optical frequency comb

The ERGO laser is a passively mode-locked femtosecond Er:Yb:glass oscillator emitting in the Telecom band of 1.5 μm [43]. It achieves sub-200-fs transform-limited pulses with more than 100 mW average output power at a repetition rate of $f_{\text{rep}} = 75$ MHz [44]. The active medium is made of a 2-mm thick Brewster-angled phosphate glass plate (Kigre ER/QX) with erbium (Er^{3+}) and ytterbium (Yb^{3+}) doping densities of $1.5 \times 10^{20} \text{ cm}^{-3}$ and $1.9 \times 10^{21} \text{ cm}^{-3}$, respectively, pumped by a 600-mW fiber-coupled Telecoms-grade

laser diode emitting at 976 nm. The gain is provided by the Er^{3+} ions, which constitute a three-level system with an upper state lifetime of 7.9 ms [45]. Yb^{3+} co-doping is used for efficient absorption of the pump power through the strong Yb^{3+} absorption band at 976 nm, associated with the efficient resonant energy transfer from the ytterbium ions to the erbium ions [46]. Due to the much higher Yb^{3+} concentration, pumping essentially occurs through Yb and direct Er pumping is marginal. A semiconductor saturable absorber mirror (SESAM) is used for stable and self-starting soliton mode-locking [47]; it has $<0.2\%$ nonsaturable losses, a saturation fluence of $F_{\text{sat}} = 25 \mu\text{J}/\text{cm}^2$ and a modulation depth of 0.5 %. The 2-m long resonator contains 10 dispersive GTI (Gires-Tournois interferometer) dielectric mirrors with a total negative dispersion of -2000 fs^2 per cavity round-trip and an output coupler with 1.7 % transmission. The duration of the pulses, determined by the amount of negative dispersion and self-phase modulation, can be adjusted with the pump power and this property is used to control the CEO frequency as discussed later. The CEO-beat is detected in a standard f -to- $2f$ interferometer [48] after coherent octave-spanning supercontinuum generation in a 1.5-m long dispersion-flattened, polarization-maintaining, highly nonlinear fiber.

3 Comb control

Full control and stabilization of the frequency comb requires two independent actuators to adjust the repetition rate f_{rep} and the CEO frequency f_{CEO} . Once these parameters are stabilized to a proper frequency reference, the frequency of any comb line is determined, given by the well-known comb equation

$$\nu_N = N \cdot f_{\text{rep}} - f_{\text{CEO}} \quad (1)$$

where the large integer number N is the comb mode index. We consider a negative sign in Eq. (1) for convenience, in order that f_{CEO} corresponds to the smallest positive frequency signal observed in the RF spectrum at the output of the f -to- $2f$ interferometer (i.e. $0 < f_{\text{CEO}} < f_{\text{rep}}/2$). The offset frequency f_{CEO} represents the shift of the comb from the origin as the mode index N is extrapolated towards zero, according to the standard comb representation in the frequency domain [2]. It corresponds to a down-shifted value of the group-phase offset frequency f_{GPO} [48] that results from the pulse-to-pulse change in the carrier-envelope offset phase $\Delta\varphi_{\text{CEO}}$ [49]:

$$f_{\text{GPO}} = f_{\text{rep}} \Delta\varphi_{\text{CEO}} / 2\pi \quad (2)$$

Physically, the group-phase offset frequency f_{GPO} results from a difference between the group and phase velocity in the laser resonator and is related to the phase evolution of

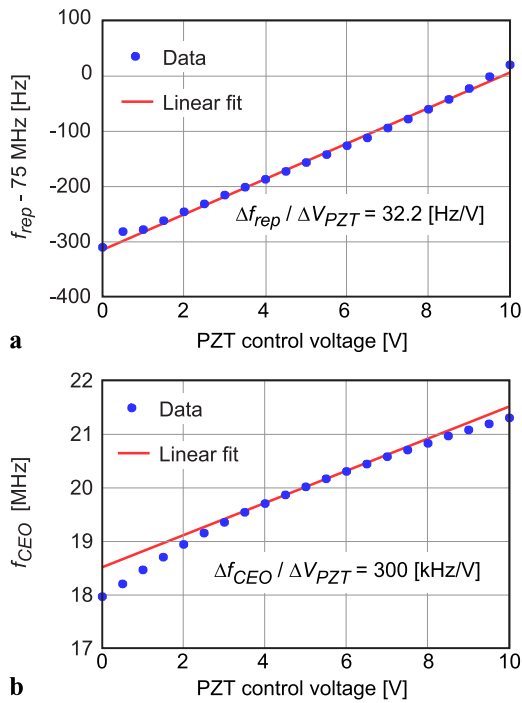

Fig. 1 Tuning of the 75-MHz repetition rate (a) and of the 20-MHz CEO frequency (b) as a function of the input voltage of the PZT controlling the cavity length. The repetition rate and the CEO frequency were measured using an electrical spectrum analyzer. The local tuning coefficients (around 75 MHz for f_{rep} and 20 MHz for f_{CEO}) are determined from a linear fit (straight lines)

the electrical field of the light pulse with respect to the pulse envelope [50]. f_{GPO} usually is in an inaccessible frequency range of $\approx 1\text{--}3$ THz in an Er-fiber laser [49–51], so that the down-shifted value $f_{CEO} = f_{GPO} \pm k f_{rep}$ is generally considered and is referred to as the CEO frequency [48]. The sign of the CEO-beat in our comb has been unambiguously determined by observing the displacement of the beat frequency between one comb line and a 1.56- μm cavity-stabilized ultra-narrow linewidth (< 10 Hz) laser when f_{rep} and f_{CEO} were successively scanned. The result of this measurement led us to adopt the sign convention of Eq. (1).

The comb repetition rate directly scales with the inverse of the resonator length, so that it can be straightforwardly adjusted by tuning the cavity length. The control of the cavity length is implemented in our laser with a stepper-motor for coarse tuning and a piezo transducer (PZT) for fine adjustment, both devices acting on the position of the SESAM in the resonator. The PZT is connected to the output of a high-voltage amplifier (0–150 V), which is driven by an input control voltage V_{PZT} (0–10 V). Figure 1a illustrates the effect of the PZT control voltage on the 75-MHz laser repetition rate, measured using an electrical spectrum analyzer when changing the cavity length step-by-step (static tuning coefficient). A large, linear and precise control of the repetition rate can be achieved with the PZT, with a tuning coefficient

$\Delta f_{rep} / \Delta V_{PZT}$ around 30 Hz/V. Besides its direct effect on the repetition rate, a change of the cavity length has also a coupled effect on the 20-MHz CEO frequency, as illustrated in Fig. 1b, with a tuning coefficient that is four orders of magnitude larger ($\Delta f_{CEO} / \Delta V_{PZT} \approx 3 \times 10^5 \text{ Hz/V}$).

Different reasons may explain the origin of the dependence of the CEO frequency f_{CEO} on the cavity length. A first contribution arises from the fact that f_{GPO} is the product of $\Delta\varphi_{CEO}$ and f_{rep} , according to Eq. (2). Therefore, the group-phase offset frequency critically depends on f_{rep} and so does the CEO frequency [52], which thus directly scales with the cavity length. Furthermore, the carrier-envelope phase $\Delta\varphi_{CEO}$ can change due to a shift in the pulse envelope arrival time or due to a shift in the carrier phase [49], so that the CEO frequency depends on the difference between phase and group velocities in the resonator [51]. Changing the cavity length with the PZT should only change a tiny portion of the cavity length in air if we neglect other side effects such as a change in the intra-cavity beam diameter. Because of the very small dispersion and nonlinearities of air, we believe that the air length change should have a minor impact on the CEO phase and thus on the CEO frequency [53]. However, this reasoning is valid for the group-phase offset frequency f_{GPO} only. This means that the fixed point of the comb for cavity length fluctuations should correspond to f_{GPO} . The fixed point is the comb mode for which the correlated breathing and translational fluctuations of the comb compensate each other as described by the comb elastic tape model [54]. Considering the down-converted value f_{CEO} , the effect of the large frequency shift between f_{CEO} and f_{GPO} ($\pm k \cdot f_{rep}$ in Eq. (2)) can induce a significant dependence of f_{CEO} with respect to the cavity length. The comb fixed point for cavity length change can also be determined from the ratio of the tuning coefficients of f_{CEO} and f_{rep} for PZT modulation: $N_{fix} = (\Delta f_{CEO} / \Delta V_{PZT}) / (\Delta f_{rep} / \Delta V_{PZT})$, which is in the order of 10,000 in our comb. This leads to a fixed point of ≈ 0.75 THz, which is comparable to the typical value of ≈ 1 THz encountered in Er-fiber lasers [49–51].

Finally, one should point out that the effect of a variation of the cavity length on the frequency of an optical comb line is strongly dominated by the contribution of the repetition rate compared to the CEO contribution, due to the large mode index ($N \approx 2.5 \times 10^6$ at $\lambda = 1.55 \mu\text{m}$) that multiplies f_{rep} .

As f_{CEO} depends on the difference between phase velocity and group velocity in the resonator, it is affected by optical nonlinearities. Almost every component in the optical resonator affects the group-phase velocity offset, either directly or indirectly, and thus modifies f_{CEO} [55]. For instance, moving any mechanical component in the cavity (flat or spherical mirror, SESAM, gain position or tilt angle, pump beam collimator, etc.) slightly affects the pulses

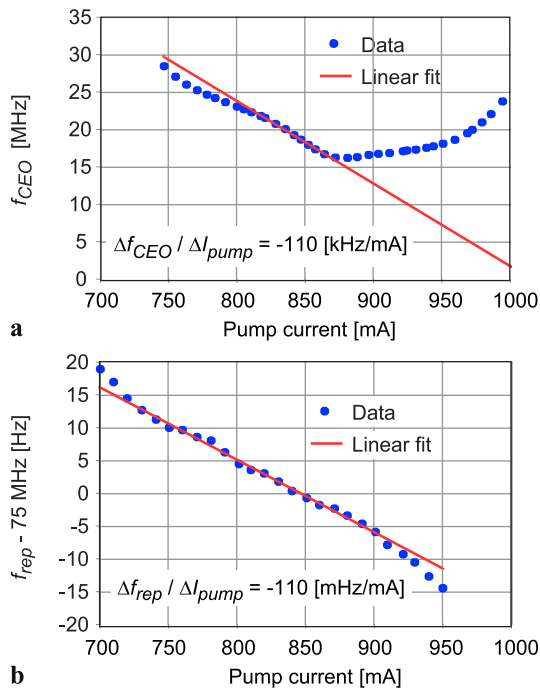

Fig. 2 Tuning of the 20-MHz CEO frequency (**a**) and of the 75-MHz repetition rate (**b**) as a function of the pump laser current. The repetition rate and the CEO frequency were measured using an electrical spectrum analyzer. The local tuning coefficients (around 20 MHz for f_{CEO} and 75 MHz for f_{rep}) are determined from a linear fit (straight lines)

and their overlap with the pump beam, leading to a change in the group velocity. These intra-cavity components can thus be used for coarse adjustment of the CEO-beat in order to tune it into a frequency range where it can be more precisely adjusted by the pump power. Indeed, the pump power has a direct influence on the pulse parameters, such as pulse duration and energy, which directly translates into a change of f_{CEO} . Therefore, the current of the pump laser can be used for fine tuning and stabilization of f_{CEO} , which is the standard stabilization method for diode-pumped femtosecond lasers [50]. The dependence of f_{CEO} on the pump power may be nonlinear and even non-monotonous as observed in Ti:sapphire combs [56]. For this reason, an initial coarse adjustment is usually done with an intra-cavity element. In a next step, the local dependence of f_{CEO} with the pump power is used for precise control and stabilization. In Fig. 2a, we show the dependence of f_{CEO} on the pump current in the ERGO laser. A tuning coefficient in the range of $\Delta f_{CEO} / \Delta I_{pump} \approx -100$ kHz/mA is achieved around 20 MHz (frequency at which f_{CEO} is stabilized in our comb, see Sect. 4), but this value can be changed by a significant amount and its sign can even be reversed, depending on the resonator configuration (precise adjustment of the intra-cavity elements).

In addition to its effect on f_{CEO} , the pump power also affects the repetition rate (Fig. 2b) due to the resulting change

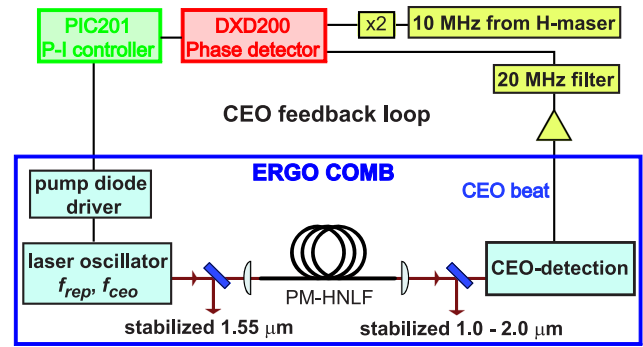

Fig. 3 Scheme of the CEO stabilization loop, including a frequency-doubled 10-MHz reference from an H-maser, a digital phase detector, a PI servo-controller and feedback to the pump laser current

in the resonator optical path length (combination of thermal and Kerr lensing as well as a slight red-shift of the center wavelength at higher pump power due to the inversion dependent gain profile). The tuning coefficient is about one million times smaller ($\Delta f_{rep} / \Delta I_{pump} \approx -100$ mHz/mA). However, this small tuning factor is not negligible considering the effect of the pump current on an optical comb line. Due to the large scaling of the repetition rate by the mode index $N \approx 2.5 \times 10^6$, both the change of the CEO and the repetition rate for a variation of the pump current introduce similar contributions to the tuning of an optical comb line.

The cavity PZT and the pump laser current are used as two actuators for the full stabilization of the ERGO comb. More precisely, the cavity PZT is used for the stabilization of the repetition rate and the pump laser current for the stabilization of the CEO frequency, as discussed in the next sections.

4 Comb self-referencing

Figure 3 schematizes the CEO stabilization loop. A commercial locking electronics (Menlosystems XPS800-E) is used to phase-stabilize the CEO-beat to a 20-MHz external reference (frequency-doubled 10-MHz signal from an H-maser). Phase fluctuations between the CEO-beat and the reference signal are detected with a digital phase detector (DXD200 from Menlosystems) with a large, linear detection range of $\pm 32 \cdot 2\pi$ phase difference. The wide dynamic range of this phase detector can track large phase fluctuations of much more than 2π , which makes the system stable in cycle-slip-free operation against large and sudden external perturbations. The error signal is forwarded to a PI servo-controller (Menlo PIC201) that drives the pump laser current source.

This leads to a tight phase-lock characterized by the suppression of the CEO linewidth. The low noise prop-

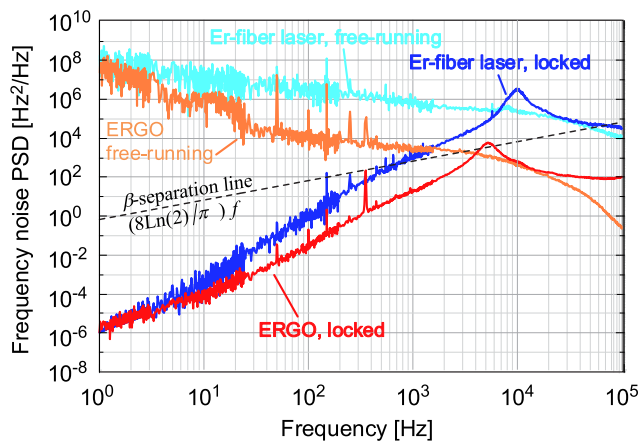

Fig. 4 Comparison of CEO frequency noise PSD in the ERGO comb and in a commercial Er: fiber comb in free-running and phase-locked modes

erties of the CEO-beat in the ERGO comb that were reported in [40] are compared in Fig. 4 to a standard commercial Er: fiber comb (FC1500-250 from Menlosystems, Germany, with 250 MHz repetition rate), both in free-running and phase-locked conditions. While we previously showed a comparison between the ERGO and Er: fiber laser in terms of Allan deviation, the comparison reported here contains much more information about the spectral distribution of the noise in these two systems. The 5.5-kHz feedback bandwidth used in the ERGO comb is slightly lower than in the commercial self-referenced Er: fiber comb ($\approx 10\text{--}20$ kHz), but is sufficient to fully reduce the frequency noise power spectral density (PSD) of the CEO-beat, $S_{\delta\nu}(f)$, below the β -separation line introduced by Di Domenico et al. [57], $S_{\delta\nu}(f) = (8 \ln(2) / \pi^2) \cdot f$, which determines those spectral components contributing to the linewidth of the CEO-beat. The lower CEO frequency noise in the ERGO comb and in particular its crossing with the β -separation line that occurs at a much lower frequency of ≈ 3 kHz compared to ≈ 100 kHz in the fiber comb makes it much easier to achieve a tight phase lock characterized by the suppression of the CEO linewidth. In the fiber comb a feedback bandwidth of at least 100 kHz would be required. This is not possible with the present electronics and a phase lead filter would be needed to compensate for the phase delay induced by the limited response bandwidth of the Er gain medium coupled with the laser dynamics [49].

The low-noise properties of the CEO make the ERGO comb very attractive as an optical-to-microwave frequency divider for all-optical ultra-low noise microwave generation [41, 42], despite its low repetition rate, as the CEO contribution to the phase noise and relative stability of the generated microwave are negligible.

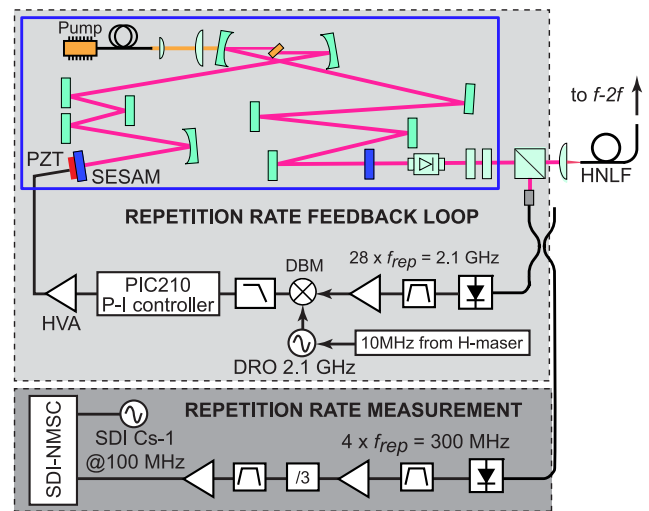

Fig. 5 Scheme of the repetition rate phase-lock loop (upper frame), including a 2.1-GHz DRO referenced to an H-maser, an analog phase comparator (double balanced mixer, DBM), a PI servo-controller, a high voltage amplifier (HVA) and feedback to the PZT to stabilize the laser cavity length. The lower frame shows the measurement scheme used to characterize the phase noise of the comb repetition rate against a low-noise 100-MHz synthesizer (SDI Cs-1) using a phase noise measurement system (SDI-NMSC)

5 Comb stabilization to an RF reference

Phase-stabilization of the repetition rate to an RF reference is performed using customized commercial stabilization electronics (Menlosystems RRE100) as depicted in Fig. 5. Less than 300 μW of the laser output power is used for detection in a fiber-coupled fast photodiode (Thorlabs DET01CFC with 2 GHz bandwidth). The 28th harmonic of f_{rep} at 2.1 GHz is used to enhance the detection sensitivity to phase fluctuations. This spectral component is bandpass-filtered, amplified and compared to a 2.1-GHz reference signal in an analog phase comparator (double-balanced mixer). The reference signal is provided by a dielectric resonator oscillator (DRO, model Miteq DLCRO-010-02100) referenced to the same H-maser as used for the CEO stabilization. The error signal at the output of the phase comparator is low-pass filtered and forwarded to a PI servo-controller (Menlo PIC210) to generate the correction signal, which is amplified in a high voltage amplifier with 23 dB gain to drive the PZT that controls the laser cavity length.

5.1 Noise properties of the repetition rate

The noise of the repetition rate has been characterized using a phase noise measurement system (from SpectraDynamics Inc., USA). The measurement principle is depicted in Fig. 5: the fourth harmonic of f_{rep} at 300 MHz was detected using an independent, out-of-loop, fast photodiode (New-Focus 1434, 25 GHz bandwidth), then filtered, amplified and frequency-divided by 3 to be measured against

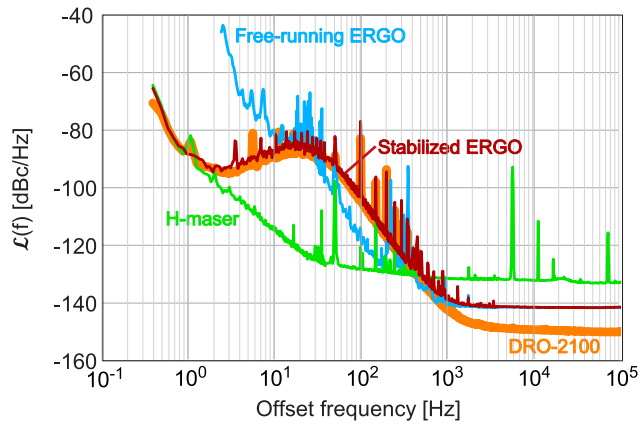

Fig. 6 Single-sideband phase noise spectrum of the repetition rate in the free-running and fully stabilized ERGO comb. The phase noise spectra of the 2.1-GHz DRO and of the H-maser, measured with the same instrumentation, are also shown. All spectra have been measured at 100-MHz carrier frequency and scaled to $f_{\text{rep}} = 75$ MHz

a low phase noise 100-MHz synthesizer (SpectraDynamics Cs-1). The phase noise of the repetition rate, measured in the free-running and stabilized ERGO comb, is displayed in Fig. 6 in terms of the single-sideband phase noise $\mathcal{L}(f) = 10 \log(S_{\delta\nu}(f)/(2f^2))$. While the low-frequency noise is strongly reduced by the feedback loop as expected, excess noise is observed in the range 2–400 Hz compared to the H-maser. This noise is of technical origin as the noise spectrum of the stabilized repetition rate coincides precisely with the noise of the DRO, which was separately measured. This indicates that the repetition rate stabilization loop works properly and that the noise of the frequency reference is transferred to the repetition rate (within the loop bandwidth). A slight improvement can be achieved by stabilizing the repetition rate to a lower noise RF oscillator (see Sect. 5.2), but significantly better results are obtained when the comb is stabilized to an optical reference (see Sect. 6).

5.2 Optical comb line properties

The noise properties of an optical comb line at 1.56 μm have been characterized from the heterodyne beat signal with a cavity-stabilized ultra-narrow linewidth laser (see details in Sect. 6). The beat signal was measured with a fiber-coupled photodiode by combining ≈ 800 μW from the 1557.5-nm ultra-stable laser with ≈ 200 nW from the ERGO laser output beam, spectrally filtered to a 0.3-nm (40 GHz) width using a diffraction grating. About 500 comb lines contribute to the detected comb optical power, corresponding to an average power of less than 0.5 nW per comb line. Despite this low power, a beat signal with a signal-to-noise ratio higher than 30 dB (at 100 kHz resolution bandwidth) was detected at ≈ 29 MHz. After filtering and amplification, the beat signal was mixed with a 236-MHz reference signal to be de-

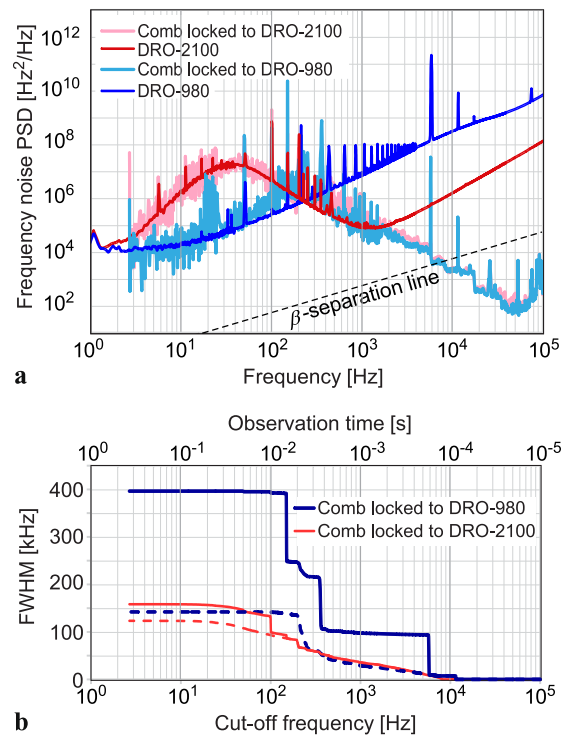

Fig. 7 (a) Frequency noise spectrum of a comb line at 1558 nm measured from the heterodyne beat with a cavity-stabilized laser for the comb repetition rate phase-locked to two different RF references. The frequency noise spectra of the two references (DRO-980 and DRO-2100), independently measured and scaled to the optical carrier frequency, are also displayed. (b) Linewidth (FWHM) of a comb optical line at 1558 nm calculated from the measured frequency noise spectrum [57] as a function of the cut-off frequency (inverse of the observation time), obtained for the comb repetition rate locked to the two different DROs. The *straight lines* are obtained by considering the entire frequency noise spectrum, while the *dashed lines* are obtained by removing the contribution of some parasitic noise peaks present in the frequency noise spectra of the references (mainly 50 Hz and harmonics as well as 5.7 kHz for DRO-980)

modulated by a home-made PLL-based frequency discriminator operating at 207 MHz [58]. The noise of the demodulated beat signal was measured on a FFT spectrum analyzer. The measured frequency noise PSD of the beat signal corresponds to the noise of the optical comb line $S_{\nu}(f)$ because the contribution of the ultra-stable laser is negligible.

Measurements were made with the comb repetition rate stabilized to two different RF references for comparison. In the first case, the comb was stabilized to the 2.1-GHz DRO (DRO-2100) as described above. In the second case, the repetition rate was locked to a 980-MHz DRO (DRO-980, from WORK Microwave GmbH, Germany) with a significantly different phase noise spectrum. In this scheme, the 13th harmonic of the repetition rate at 975 MHz was first mixed with the signal of the DRO-980 and the resulting difference frequency component was phase-locked to the 5-MHz reference signal from the H-maser, using the same feedback loop as before. Figure 7a compares the frequency noise of

an optical comb line at 1558 nm obtained with the two different repetition rate stabilization schemes. For comparison, the contribution of each reference oscillator, separately measured and scaled to the optical frequency, is also displayed. One notices that the DRO-980 exhibits 25 dB lower noise at 20 Hz, which directly improves the comb line frequency noise by the same factor. However, the DRO-980 is referenced (phase-locked) to the 10-MHz H-maser with a much broader bandwidth than in case of the DRO-2100. As a consequence, some noise components that are present in the H-maser phase noise spectrum are transferred to the DRO-980 and subsequently to the comb through the repetition rate stabilization loop. This is, e.g., the case for the 5.7-kHz peak (as well as the 11.4-kHz harmonic) that originates from the particular realization of the PLL that locks the quartz local oscillator to the hydrogen atomic transition in the maser. These peaks have a significant contribution to the optical linewidth shown in Fig. 7b, calculated from the measured frequency noise spectrum [57] as a function of the observation time T_0 . A linewidth of ≈ 160 kHz is obtained for $T_0 > 100$ ms with the DRO-2100, but a large contribution to this linewidth originates from the excess noise of the DRO used for the stabilization of the comb repetition rate. A small contribution also results from parasitic 50 Hz and harmonics noise peaks (mainly at 100 Hz). The optical linewidth is slightly reduced to ≈ 130 kHz when these contributions are removed from the frequency noise spectrum. In spite of the lower phase noise of the DRO-980 at low Fourier frequencies, the optical linewidth obtained with the repetition rate stabilized to this reference is broader (≈ 400 kHz). However, the major contribution to this linewidth originates from isolated peaks in the DRO phase noise spectrum, such as 50 Hz and harmonics, ≈ 350 Hz and 5.7 kHz. If the contribution of these noise peaks to the linewidth is removed, a similar value is obtained as with the DRO-2100.

The fractional frequency instability (Allan deviation) of the comb repetition rate and of a 1558-nm comb line are shown in Fig. 8 for the comb locked to the DRO-2100 (Fig. 8a) and the DRO-980 (Fig. 8b). For the repetition rate, a signal at $4f_{\text{rep}}/3$ (according to the experimental scheme of Fig. 5) was measured in comparison to a second independent H-maser (with a better frequency stability compared to the H-maser used for the comb stabilization) in a 100-MHz frequency comparator (Vremya VCH-307). The Allan deviation was determined from the instantaneous fractional frequency deviation recorded with 1 s gate time. The frequency stability of the two DROs, as well as of the reference H-maser, has been measured in the same way. For the characterization of the optical comb line, the frequency of the beat signal between the comb line and the cavity-stabilized laser was measured in a multi-channel digital frequency counter [59] (FXM50 model from K&K Messtechnik, Germany) with 1 s gate time.

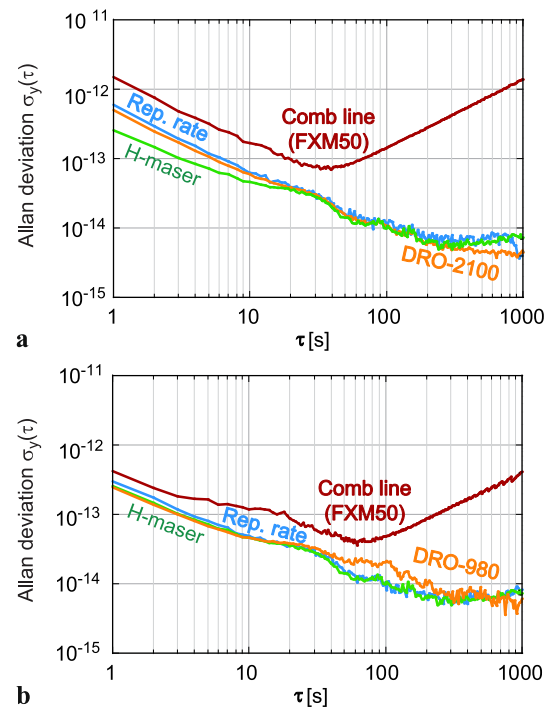

Fig. 8 Fractional frequency stability (Allan deviation) obtained for the ERGO comb locked to two different RF references, DRO-2100 (a) and DRO-980 (b). The comb repetition rate has been measured with a Vremya frequency comparator. The frequency stability of an optical comb line was assessed from the frequency of the heterodyne beat with a cavity-stabilized laser, measured using a Π -type counter (FXM50). The Allan deviation of the DROs and H-maser are shown as well. Only the FXM50 measurement of the comb line frequency yields the true Allan deviation

The fractional frequency stability of the comb repetition rate and of the DRO coincides for both DROs, at the level of 6×10^{-13} (DRO-2100) and 2.5×10^{-13} (DRO-980), respectively, at 1 s averaging time. This shows that the performance of the comb is limited by the RF oscillator used for the repetition rate stabilization. The degradation of the short-term stability with the DRO-2100 results from its excess low-frequency phase noise, which contributes to the Allan deviation even at integrating times up to 20 s compared to the reference H-maser (despite the low-pass filtering effect of the frequency comparator that reduces the contribution of the phase noise at higher Fourier frequencies, as discussed below).

A larger fractional frequency instability is observed for the optical comb line in comparison to the repetition rate. This is not a result of an additional noise process in the comb, but only reflects a different mode of operation of the frequency counters, which are used to record the time evolution of the repetition rate and optical comb line frequencies. The FXM50 counter used to record the frequency of the heterodyne beat signal is a Π -type counter [60] that takes only one frequency value after each expired gate time, with no dead time. Only this type of counter yields the true Allan

deviation as discussed by Bernhardt et al. [61]. If the frequency counter has a dead time where no data are acquired, an underestimated value of the Allan deviation is extracted. This is also the case for counters that realize a particular averaging of the frequency over the gate time or that perform some additional low-pass filtering, as a consequence of the reduced sensitivity to frequency fluctuations at high Fourier frequencies [62]. The difference between the “true” Allan deviation as defined in [63] and the underestimate obtained with filtered high Fourier frequency noise components depends on the type of noise. It becomes more relevant for white phase noise than for white frequency noise [62]. The Vremya frequency comparator used for the repetition rate stability measurements (and incidentally for the DROs and the H-maser) has a 3-Hz low-pass filter. This filter strongly attenuates the influence of higher Fourier frequencies in the Allan deviation, which leads to an incorrectly lowered Allan deviation at short integration times. Therefore, the Allan deviation of the optical comb line assessed from the FXM50 counter better characterizes the comb stability. A fractional frequency stability of 1.5×10^{-12} is obtained at 1 s in case of the DRO-2100 reference and 4.2×10^{-13} for the DRO-980 reference, respectively (Fig. 8). The improved noise properties of the DRO-980 (at least at low Fourier frequencies) enable the relative stability of the comb to be increased by a factor of 3–4 (at 1 s). The drift observed in the Allan deviation above a few ten seconds results from the frequency drift of the cavity-stabilized laser.

6 Comb stabilization to an optical reference

Section 5 showed that the comb performances (frequency noise and stability) are limited by the microwave oscillator used to stabilize the repetition rate. Much better performances may be achieved by stabilizing a comb to an optical reference as previously reported for different comb technologies [64, 65]. We show here preliminary results of the stabilization of the ERGO comb to an optical reference and a characterization of the corresponding frequency stability.

Our optical reference is a 1558-nm ultra-stable laser [66], made of an extended cavity diode laser frequency-stabilized to a high finesse optical resonator using the Pound–Drever–Hall (PDH) locking scheme [67]. The finesse of the resonator is $\approx 185,000$ as experimentally determined from a ring-down decay time measurement. The 10-cm long, horizontally mounted reference cavity is made of an ultra-low expansion (ULE) glass spacer with optically contacted high-reflectivity ULE-substrate mirrors. The cavity is supported on four specific points to minimize its sensitivity to vibrations [68], and is mounted in a 2-layer thermal enclosure actively stabilized at the temperature turning point where its coefficient of thermal expansion (CTE) is zeroed (measured

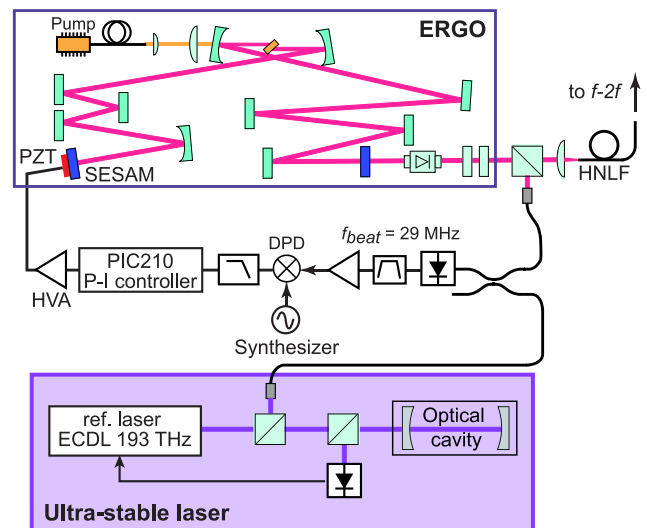

Fig. 9 Scheme of the phase-lock loop of a comb line to an optical reference (cavity-stabilized laser). The heterodyne beat between the 1558-nm laser and the nearest comb line is detected in a fiber-coupled photodiode. The beat frequency is compared to the reference signal of a synthesizer in a digital phase detector (DPD) and feedback is applied, after filtering and amplification, to the PZT of the fs-laser resonator

at 22.6 °C in our cavity). The overall system is placed in a vacuum chamber evacuated to $< 10^{-7}$ mbar.

The ERGO comb is stabilized to the optical reference by phase-locking the beat signal between the laser and the nearest comb line to a stable reference synthesizer, as depicted in Fig. 9, and the CEO frequency is independently stabilized at 20 MHz as before. The laser-comb beat frequency is compared to the synthesizer signal in a digital phase detector (DXD200) of the same type as used for the CEO stabilization (see Sect. 4) in order to generate the error signal. This signal is used for feedback to the cavity PZT, after proper amplification by the servo-controller and high voltage amplifier.

For an ideal stabilization of the comb to the ultra-stable laser, the fractional frequency stability of the laser is transferred to the comb repetition rate. Moreover, the resulting phase noise PSD of the repetition rate should correspond to the laser phase noise divided by the large squared mode number N^2 (with $N \approx 2,570,000$ in the present case) because the comb acts as a frequency divider. This property allows ultra-low noise microwave to be generated [41, 42]. However, achieving such an ideal division generally requires a large feedback bandwidth of some hundred kilohertz to tightly lock the comb to the laser. This cannot be presently obtained in our comb because feedback was applied to the cavity PZT with a feedback bandwidth of ≈ 10 kHz only. Much faster actuators, such as intra-cavity electro-optic modulators, are generally used to achieve a high bandwidth lock of a frequency comb to an optical reference [69, 70].

As a preliminary evaluation of the use of the ERGO comb for ultra-stable micro-wave generation, we measured the fre-

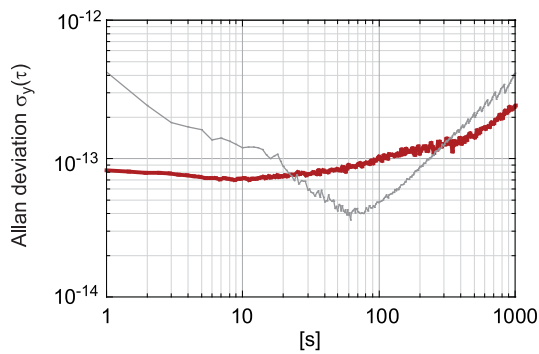

Fig. 10 Fractional frequency stability of the repetition rate of the ERGO comb locked to the ultra-stable laser (*red thick curve*) compared against an oven-controlled crystal oscillator (BVA type 8607-B from Oscilloquartz SA), which is the most stable RF reference at very short-term (up to a few seconds) available in our laboratory. The measurement is limited by the reference oscillator at $\tau < 20$ s. For comparison, the stability of an optical line of the comb stabilized to a microwave reference (DRO-980 referenced to H-maser) is shown by the thin gray curve (from Fig. 8b)

quency stability (Allan deviation) of the repetition rate of the comb locked to the optical reference. For this purpose, the comb repetition rate was frequency-divided by 15 and measured against a highly stable oven-controlled crystal oscillator [71] (OCXO, model BVA type 8607-B from Oscilloquartz SA, Neuchâtel, Switzerland), which was the best microwave oscillators available in our laboratory in terms of frequency stability at very short-term (relative stability inferred to 8×10^{-14} at 1 s from the comparison of two similar oscillators). The measurement was performed using a TimePod 5330A cross spectrum analyzer. The experimental result displayed in Fig. 10 shows a fractional frequency stability of 8×10^{-14} at 1 s, decreasing slowly to 7×10^{-14} at 10 s, limited at this timescale by the frequency reference used in the comparison. The drift at longer timescales mainly results from the drift of the optical cavity resonance (≈ 50 mHz/s).

7 Conclusion and outlook

We have carefully characterized the noise properties of the first fully stabilized optical frequency comb from a diode-pumped solid-state laser (DPSSL) in the 1.5- μm spectral region. The laser is a SESAM-mode-locked Er:Yb:glass laser oscillator referred to as the ERGO laser. The characterization of the ERGO comb has been made for the CEO-beat, for the repetition rate and for an optical comb line at 1558 nm. The later was assessed from the heterodyne beat signal between the comb line and a cavity-stabilized ultra-narrow linewidth laser. As a result of the low-noise properties of the CEO-beat, the noise of an optical comb line is limited by the repetition rate only when the comb is stabilized to an RF reference and the CEO contribution is negligible at all Fourier

frequencies. Two stabilization schemes were implemented to lock the repetition rate to an RF reference, using two different DROs (at 2.1 GHz and 980 MHz, respectively) with a very different phase noise spectrum. The frequency noise characteristics of the RF reference are transferred in each case to the comb repetition rate and thus to the comb optical lines. Despite the significantly different frequency noise spectra obtained with the two DROs as a reference, a similar comb linewidth of ≈ 150 kHz resulted in both cases. The linewidth was determined from the frequency noise spectrum where the contribution of some spurious noise peaks was removed. In terms of short-term fractional frequency stability of the comb line, a more than 3-fold improved Allan deviation has been achieved with the use of the DRO-980 (4.2×10^{-13} vs. 1.5×10^{-12} at 1 s), as a consequence of its lower frequency noise at low Fourier frequencies. The higher relative instability of the comb line compared to the reference DRO has been discussed and results from the different type of counter used to compute the Allan deviation. The Π -type counter used to measure the frequency of the beat note between the comb line and an ultra-stable laser is the most representative of the “true” Allan deviation of the comb. Slight improvements of the frequency noise, linewidth and short-term stability of the ERGO comb may be achieved by the use of a better (lower noise) DRO for the stabilization of the repetition rate. Nevertheless, much better results may be obtained by referencing the comb directly to an optical reference. Preliminary experiments in this direction have shown some significant improvements in terms of short-term stability for the comb stabilized to an ultra-stable laser at 1558 nm. The measured fractional frequency stability of 8×10^{-14} at 1 s integration time corresponds to the instability of the reference oscillator used in the comparison and shows that the present comparison is limited by the best frequency reference available in our laboratory. A complete evaluation of the optically referenced ERGO comb will require the development of a second independent ultra-stable laser to be compared against.

Acknowledgements The authors would like to thank Dr Jacques Chauvin (Oscilloquartz) for the loan of the BVA-5607B OCXO used in the evaluation of the ERGO comb stabilized to the optical reference and Dr. Luc Schneller for this support in these measurements. This work was financed by ETH Zurich through the “Multiwave” project, by the Swiss National Science Foundation (SNSF) and by the Swiss Confederation Program Nano-Tera.ch which was scientifically evaluated by the SNSF.

References

1. T.W. Hänsch, *Rev. Mod. Phys.* **78**, 1297 (2006)
2. J. Ye, H. Schnatz, L.W. Hollberg, *IEEE J. Sel. Top. Quantum Electron.* **9**, 1041 (2003)
3. S.A. Diddams, Th. Udem, J.C. Bergquist, E.A. Curtis, R.E. Drullinger, L. Hollberg, W.M. Itano, W.D. Lee, C.W. Oates, K.R. Vogel, D.J. Wineland, *Science* **293**, 825 (2001)

4. U. Sterr, C. Degenhardt, H. Stoehr, C. Lisdat, H. Schnatz, J. Helmcke, F. Riehle, G. Wilpers, C. Oates, L. Hollberg, C. R. Phys. **5**, 845 (2004)
5. A. Bartels, C.W. Oates, L.W. Hollberg, S.A. Diddams, Opt. Lett. **29**, 1081 (2004)
6. M.C. Stowe, M.J. Thorpe, A. Pe'er, J. Ye, J.E. Stalnaker, V. Gerginov, S.A. Diddams, Adv. At. Mol. Opt. Phys. **55**, 1 (2008)
7. M.J. Thorpe, K.D. Moll, R.J. Jones, B. Safdi, J. Ye, Science **311**, 1595 (2006)
8. S.A. Diddams, L. Hollberg, V. Mbebe, Nature **445**, 627 (2007)
9. M.J. Thorpe, J. Ye, Appl. Phys. B **91**, 397 (2008)
10. J. Mandon, G. Guelachvili, N. Picqué, Nat. Photonics **3**, 99 (2009)
11. K.A. Tillman, R.R.J. Maier, D.T. Reid, E.D. McNaghten, Appl. Phys. Lett. **85**, 3366 (2004)
12. F. Adler, P. Maslowski, A. Foltynowicz, K.C. Cossel, T.C. Briles, I. Hartl, J. Ye, Opt. Express **18**, 21861 (2010)
13. E. Sorokin, I.T. Sorokina, J. Mandon, G. Guelachvili, N. Picqué, Opt. Express **15**, 16540 (2007)
14. A. Foltynowicz, T. Ban, P. Maslowski, F. Adler, J. Ye, Phys. Rev. Lett. **107**, 233002 (2011)
15. S. Schiller, Opt. Lett. **27**, 766 (2002)
16. F. Keilmann, C. Gohle, R. Holzwarth, Opt. Lett. **29**, 1542 (2004)
17. B. Bernhardt, A. Ozawa, P. Jacquet, M. Jacquy, Y. Kobayashi, T. Udem, R. Holzwarth, G. Guelachvili, T.W. Hänsch, N. Picqué, Nat. Photonics **4**, 55 (2010)
18. I. Coddington, W.C. Swann, N.R. Newbury, Phys. Rev. Lett. **100**, 013902 (2008)
19. A. Schliesser, M. Brehm, F. Keilmann, D.W. van der Weide, Opt. Express **13**, 9029 (2005)
20. M.J. Cich, C.P. McRaven, G.V. Lopez, T.J. Sears, D. Hurtmans, A.W. Mantz, Temperature-dependent pressure broadened line shape measurements in the $\nu_1 + \nu_3$ band of acetylene using a diode laser referenced to a frequency comb. Appl. Phys. B (2012, in press), doi:[10.1007/s00340-011-4829-0](https://doi.org/10.1007/s00340-011-4829-0)
21. P. Cancio, S. Bartalini, S. Borri, I. Galli, G. Gagliardi, G. Giusfredi, P. Maddaloni, P. Malara, D. Mazzotti, P. De Natale, Appl. Phys. B **102**, 255 (2011)
22. D. Gatti, A. Gambetta, A. Castrillo, G. Galzerano, P. Laporta, L. Gianfrani, M. Marangoni, Opt. Express **19**, 17520 (2011)
23. D. Mazzotti, S. Bartalini, S. Borri, P. Cancio, I. Galli, G. Giusfredi, P. De Natale, in *CLEO/Europe and EQEC 2011 Conference Digest*, Paper CH4_3, OSA Technical Digest (CD) (Optical Society of America, Washington, 2011)
24. J. Mandon, P. Jacquet, B. Bernhardt, M. Jacquy, G. Guelachvili, T.W. Hänsch, N. Picqué, in *Conference on Lasers and Electro-Optics*. Paper CMJ3, OSA Technical Digest (CD) (Optical Society of America, Washington, 2010)
25. T. Gherman, D. Romanini, Opt. Express **10**, 1033 (2002)
26. R. Holzwarth, T. Udem, T.W. Hänsch, J.C. Knight, W.J. Wadsworth, P.S.J. Russell, Phys. Rev. Lett. **85**, 2264 (2000)
27. D.J. Jones, S.A. Diddams, J.K. Ranka, A. Stentz, R.S. Windeler, J.L. Hall, S.T. Cundiff, Science **266**, 635 (2000)
28. B.R. Washburn, S.A. Diddams, N.R. Newbury, J.W. Nicholson, M.F. Yan, C.G. Jørgensen, Opt. Lett. **29**, 250 (2004)
29. K. Kim, B.R. Washburn, G. Wilpers, C.W. Oates, L. Hollberg, N.R. Newbury, S.A. Diddams, J.W. Nicholson, M.F. Yan, Opt. Lett. **30**, 932 (2005)
30. I. Hartl, M.E. Fermann, P. Pal, W.H. Knox, in *Conference on Lasers and Electro-Optics/Quantum Electronics and Laser Science Conference and Photonic Applications Systems Technologies*. Paper CMU2, OSA Technical Digest Series (CD) (Optical Society of America, Washington, 2007)
31. S.A. Meyer, J.A. Squier, S.A. Diddams, Yb. Diode-pumped, Eur. Phys. J. D **38**, 19 (2008)
32. J. Jiang, C. Mohr, J. Bethge, M. Fermann, I. Hartl, in *CLEO/Europe and EQEC 2011 Conference Digest, Paper PDB_1*. OSA Technical Digest (CD) (Optical Society of America, Washington, 2011)
33. M.A. Gubin, A.N. Kireev, A.V. Konyashchenko, P.G. Kryukov, A.S. Shelkovich, A.V. Tausenev, D.A. Tyurikov, Appl. Phys. B **95**, 661 (2009)
34. C. Erny, K. Moutzouris, J. Biegert, D. Kühle, F. Adler, A. Leitendorfer, U. Keller, Opt. Lett. **32**, 1138 (2007)
35. P. Maddaloni, P. Malara, G. Gagliardi, P. De Natale, New J. Phys. **8**, 262 (2006)
36. N. Leindecker, A. Marandi, R.L. Byer, K.L. Vodopyanov, Opt. Express **19**, 6296 (2011)
37. F. Adler, K.C. Cossel, M.J. Thorpe, I. Hartl, M.E. Fermann, J. Ye, Opt. Lett. **34**, 1330 (2009)
38. C. Wang, T. Herr, P. Del'Haye, A. Schliesser, R. Holzwarth, T.W. Hänsch, N. Picqué, T. Kippenberg, in *CLEO:2011—Laser Applications to Photonic Applications*. Paper PDP4A, OSA Technical Digest (CD) (Optical Society of America, Washington, 2011)
39. <http://www.time-bandwidth.com/product/view/id/34>
40. S. Schilt, N. Bucalovic, V. Dolgovskiy, C. Schori, M.C. Stumpf, G. Di Domenico, S. Pekarek, A.E.H. Oehler, T. Südmeyer, U. Keller, P. Thomann, Opt. Express **19**, 24171 (2011)
41. A. Bartels, S.A. Diddams, C.W. Oates, G. Wilpers, J.C. Bergquist, W.H. Oskay, L. Hollberg, Opt. Lett. **30**, 667 (2005)
42. J. Millo, M. Abgrall, M. Lours, E.M.L. English, H. Jiang, J. Guéna, A. Clairon, S. Bize, Y. Le Coq, G. Santarelli, M.E. Tobar, Appl. Phys. Lett. **94**, 141105 (2009)
43. G.J. Spühler, L. Krainer, E. Innerhofer, R. Paschotta, K.J. Weingarten, U. Keller, Opt. Lett. **30**, 263 (2005)
44. M.C. Stumpf, S. Pekarek, A.E.H. Oehler, T. Südmeyer, J.M. Dudley, U. Keller, Appl. Phys. B **99**, 401 (2010)
45. G. Karlsson, F. Laurell, J. Tellefsen, B. Denker, B. Galagan, V. Osiko, S. Sverchikov, Appl. Phys. B **75**, 41 (2002)
46. R. Wu, J.D. Myers, M.J. Myers, C. Rapp, Proc. SPIE **4968**, 11 (2003)
47. F.X. Kärtner, I.D. Jung, U. Keller, IEEE J. Sel. Top. Quantum Electron. **2**, 540 (1996)
48. H.R. Telle, G. Steinmeyer, A.E. Dunlop, J. Stenger, D.H. Sutter, U. Keller, Appl. Phys. B **69**, 327 (1999)
49. B.R. Washburn, W.C. Swann, N.R. Newbury, Opt. Express **13**, 10622 (2005)
50. J. Rauschenberger, T.M. Fortier, D.J. Jones, J. Ye, S.T. Cundiff, Opt. Express **10**, 1404 (2002)
51. N.R. Newbury, W.C. Swann, J. Opt. Soc. Am. B **24**, 1756 (2007)
52. D.R. Walker, T. Udem, C. Gohle, B. Stein, T.W. Hänsch, Appl. Phys. B **89**, 535 (2007)
53. R. Paschotta, A. Schlatter, S.C. Zeller, H.R. Telle, U. Keller, Appl. Phys. B **82**, 265 (2006)
54. H.R. Telle, B. Lipphardt, J. Stenger, Appl. Phys. B **74**, 1 (2002)
55. F.W. Helbing, G. Steinmeyer, U. Keller, IEEE J. Sel. Top. Quantum Electron. **9**, 1030 (2003)
56. K.W. Holman, R.J. Jones, A. Marian, S.T. Cundiff, Y. Je, IEEE J. Sel. Top. Quantum Electron. **9**, 1018 (2003)
57. G. Di Domenico, S. Schilt, P. Thomann, Appl. Opt. **49**, 4801 (2010)
58. S. Schilt, N. Bucalovic, L. Tombez, C. Schori, V. Dolgovskiy, G. Di Domenico, M. Zaffalon, P. Thomann, Rev. Sci. Instrum. **82**, 123116 (2011)
59. G. Kramer, W. Klische, in *Proc. IEEE International Frequency Control Symposium and PDA Exhibition*, Seattle, USA, 6–8 June 2001
60. E. Rubiola, F. Vernotte, V. Giordano, in *Proc. IEEE International Frequency Control Symposium and Exhibition*, Vancouver, Canada, 29–31 Aug. (2005)

61. B. Bernhardt, T.W. Hänsch, R. Holzwarth, *Opt. Express* **17**, 16849 (2009)
62. S.T. Dawkins, J.J. McFerran, A.N. Luiten, *IEEE Trans. Ultrason. Ferroelectr. Freq. Control* **54**, 918 (2007)
63. D.W. Allan, *Proc. IEEE* **54**, 221 (1966)
64. A. Bartels, C.W. Oates, L.W. Hollberg, S.A. Diddams, *Appl. Opt.* **29**, 1081 (2004)
65. W.C. Swann, J.J. McFerran, I. Coddington, N.R. Newbury, I. Hartl, M.E. Fermann, P.S. Westbrook, J.W. Nicholson, K.S. Feder, C. Langrock, M.M. Fejer, *Opt. Lett.* **31**, 3046 (2006)
66. V. Dolgovskiy, S. Schilt, G. Di Domenico, N. Bucalovic, C. Schori, P. Thomann, in *Proc. IFCS&EFTF Joint Conference*, San Francisco, USA, 2–5 May (2011)
67. R.W.P. Drever, J.L. Hall, F.V. Kowalski, J. Hough, G.M. Ford, A.J. Munley, H. Ward, *Appl. Phys. B* **31**, 97 (1983)
68. J. Millo, D.V. Magalhaes, C. Mandache, Y. Le Coq, E.M.L. English, P.G. Westergaard, J. Lodewyck, S. Bize, P. Lemonde, G. Santarelli, *Phys. Rev. A* **79**, 053829 (2009)
69. Y. Nakajima, H. Inaba, K. Hosaka, K. Minoshima, A. Onae, M. Yasuda, T. Kohno, S. Kawato, T. Kobayashi, T. Katsuyama, F.-L. Hong, *Opt. Express* **18**, 1667 (2010)
70. E. Baumann, F.R. Giorgetta, J.W. Nicholson, W.C. Swann, I. Coddington, N.R. Newbury, *Opt. Lett.* **34**, 638 (2009)
71. P. Salzenstein, A. Kuna, L. Sojdr, J. Chauvin, *Electron. Lett.* **46**, 1433 (2010)